



ROHDE & SCHWARZ

Test and Measurement
Division

Operating Manual

VECTOR SIGNAL GENERATOR

SMIQ02

1084.8004.02

SMIQ03

1084.8004.03

SMIQ03A

1084.8004.53

Printed in the Federal
Republic of Germany

Tabbed Divider Overview

Contents

Data Sheet

Safety Instructions
Certificate of quality
EC Certificate of Conformity
List of R & S Representatives

Tabbed Divider

1	Chapter 1: Preparation for Use
2	Chapter 2: Manual Operation
3	Chapter 3: Remote Control
4	Chapter 4: Maintenance
5	Chapter 5: Performance Test
6	Annex A: Interfaces
7	Annex B: List of Error Messages
8	Annex C: List of Commands
9	Annex D: Programming Example
10	Index

Contents

1 Preparation for Use

1.1 Putting into Operation	1.1
1.1.1 Supply Voltage.....	1.1
1.1.2 Switching On/Off the Instrument.....	1.1
1.1.3 Initial Status	1.2
1.1.4 Setting Contrast and Brightness of the Display	1.2
1.1.5 RAM With Battery Back-Up	1.2
1.1.6 Preset Setting	1.3
1.2 Functional Test	1.3
1.3 Fitting the Options	1.4
1.3.1 Opening the Casing.....	1.4
1.3.2 Overview of the Slots.....	1.5
1.3.3 Option SM-B1 - Reference Oscillator OCXO.....	1.5
1.3.4 Option SM-B5 - FM/PM Modulator	1.6
1.3.5 Option SMIQB10 - Modulation Coder	1.7
1.3.6 Option SMIQB11 - Data Generator	1.8
1.3.7 Option SMIQB12 - Memory Extension to Data Generator.....	1.8
1.3.8 Option SMIQB42 - Digital Standard IS-95 CDMA.....	1.8
1.3.9 Option SMIQB14 - Fading Simulator FSIM1	1.9
1.3.10 Option SMIQB15 - Second Fading Simulator FSIM2	1.10
1.3.11 Option SMIQ-B19 - Rear Panel Connections for RF and LF.....	1.12
1.4 Mounting into a 19" Rack	1.12

2 Operation

2.1 Explanation of Front and Rear Panel	2.1
2.1.1 Elements of the Front Panel	2.1
2.1.1.1 Display	2.1
2.1.1.2 Controls.....	2.3
2.1.1.3 Inputs/Outputs	2.11
2.1.2 Elements of the Rear Panel.....	2.13
2.2 Operating Concept	2.22
2.2.1 Display	2.22
2.2.2 Basic Operating Steps.....	2.23
2.2.2.1 Calling the Menus	2.23
2.2.2.2 Selection and Change of Parameters.....	2.24
2.2.2.3 Triggering Action.....	2.25
2.2.2.4 Quick Selection of Menu (QUICK SELECT)	2.25
2.2.2.5 Use of [FREQ] and [LEVEL] Keys	2.26
2.2.2.6 Use of [RF ON / OFF] and [MOD ON / OFF] Keys.....	2.26
2.2.2.7 Changing Unit of Level.....	2.26
2.2.2.8 Correction of Input	2.27

2.2.3 Sample Setting for First Users.....	2.27
2.2.4 List Editor.....	2.32
2.2.4.1 Select and Generate - SELECT LIST.....	2.33
2.2.4.2 Deletion of Lists - DELETE LIST.....	2.34
2.2.4.3 Edition of Lists.....	2.35
2.2.4.4 Pattern Setting to Operate the List Editor.....	2.39
2.2.5 Save/Recall - Storing/Calling of Instrument Settings.....	2.43
2.3 Menu Summary.....	2.44
2.4 RF Frequency.....	2.45
2.4.1 Frequency Offset.....	2.46
2.5 RF Level.....	2.47
2.5.1 Level Offset.....	2.49
2.5.2 Interrupt-free Level Setting.....	2.49
2.5.3 Switching On/Off Internal Level Control.....	2.50
2.5.4 User Correction (UCOR).....	2.51
2.5.5 EMF.....	2.53
2.5.6 [RF ON / OFF]-Key.....	2.53
2.5.7 Reset Overload Protection.....	2.53
2.6 Modulation.....	2.54
2.6.1 Modulation Sources.....	2.54
2.6.2 Simultaneous Modulation.....	2.56
2.6.3 [MOD ON/OFF] Key.....	2.56
2.7 Analog Modulations.....	2.57
2.7.1 LF-Generator.....	2.57
2.7.2 Amplitude Modulation.....	2.58
2.7.3 Broadband AM (BB-AM).....	2.59
2.7.4 Frequency Modulation.....	2.60
2.7.4.1 FM Deviation Limits.....	2.61
2.7.4.2 Preemphasis.....	2.61
2.7.5 Phase Modulation.....	2.62
2.7.5.1 PM Deviation Limits.....	2.63
2.7.6 Pulse Modulation.....	2.64
2.8 Vector Modulation.....	2.65
2.8.1 I/Q Impairment.....	2.67
2.9 Fading Simulation.....	2.68
2.9.1 Output Power with Fading.....	2.69
2.9.2 Two-Channel Fading.....	2.69
2.9.3 Correlation between Paths.....	2.70
2.9.4 Fading Simulation Menu.....	2.71
2.10 Digital Modulation.....	2.76
2.10.1 Digital Modulation Methods and Coding.....	2.77
2.10.1.1 PSK and QAM Modulation.....	2.77
2.10.1.2 Modulation $\pi/4$ DQPSK.....	2.78
2.10.1.3 FSK Modulation.....	2.79
2.10.1.4 Coding.....	2.79
2.10.1.5 Setting Conflicts.....	2.81
2.10.2 Internal Modulation Data and Control Signals from Lists.....	2.82

2.10.3 Internal PRBS Data and Pattern	2.84
2.10.4 Digital Data and Clock output Signals	2.85
2.10.4.1 Serial Interfaces DATA, BIT CLOCK and SYMBOL CLOCK	2.85
2.10.4.2 Parallel Interfaces DATA and SYMBOL CLOCK	2.85
2.10.5 External Modulation Data and Control Signals	2.85
2.10.5.1 External Serial Modulation Data	2.86
2.10.5.2 External Parallel Modulation Data	2.87
2.10.5.3 Asynchronous Interface for External Modulation Data	2.88
2.10.5.4 External Control Signals	2.88
2.10.6 Envelope Control	2.89
2.10.7 Clock Signals	2.90
2.10.8 RF Level For Digital Modulation	2.90
2.10.9 Digital Modulation Menu	2.91
2.11 Digital Standard PHS	2.104
2.11.1 Sync and Trigger Signals	2.105
2.11.2 PN Generators as Internal Data Source	2.106
2.11.3 Lists as Internal Data Source	2.107
2.11.4 External Modulation Data	2.107
2.11.5 Menu DIGITAL STANDARD - PHS	2.108
2.12 Digital Standard IS-95 CDMA	2.118
2.12.1 Sync and Trigger Signals	2.121
2.12.2 PRBS Data Source in Forward Link	2.122
2.12.3 PN Generators as Internal Data Source for Reverse Link	2.123
2.12.4 Menu CDMA Standard - Forward Link Signal	2.124
2.12.5 Menu CDMA Standard - Reverse Link Signal without Channel Coding	2.134
2.12.6 Menu CDMA Standard - Reverse Link Signal with Channel Coding	2.135
2.13 Digital Standard NADC	2.137
2.13.1 Sync and Trigger Signals	2.138
2.13.2 PN Generators as Internal Data Source	2.139
2.13.3 Lists as Internal Data Source	2.140
2.13.4 External Modulation Data	2.140
2.13.5 Menu DIGITAL STANDARD - NADC	2.141
2.14 Digital Standard PDC	2.155
2.14.1 Sync and Trigger Signals	2.156
2.14.2 PN Generators as Internal Data Source	2.157
2.14.3 Lists as Internal Data Source	2.158
2.14.4 External Modulation Data	2.158
2.14.5 Menu DIGITAL STANDARD - PDC	2.159
2.15 Digital Standard GSM	2.177
2.15.1 Sync and Trigger Signals	2.178
2.15.2 PN Generators as Internal Data Source	2.179
2.15.3 Lists as Internal Data Source	2.180
2.15.4 External Modulation Data	2.180
2.15.5 Menu DIGITAL STANDARD - GSM	2.181

2.16 Digital Standard DECT	2.191
2.16.1 Sync and Trigger Signals.....	2.192
2.16.2 PN Generators as Internal Data Source.....	2.193
2.16.3 Lists as Internal Data Source.....	2.194
2.16.4 External Modulation Data.....	2.194
2.16.5 Menu DIGITAL STANDARD - DECT.....	2.195
2.17 External Modulation Source AMIQ - AMIQ CTRL	2.207
2.18 LF-Output	2.215
2.19 Sweep	2.216
2.19.1 Setting the Sweep Range (START, STOP, CENTER and SPAN).....	2.216
2.19.2 Selecting the Sweep Run (SPACING LIN, LOG).....	2.217
2.19.3 Operating Modes (MODE).....	2.217
2.19.4 Trigger Input.....	2.218
2.19.5 Sweep Outputs.....	2.218
2.19.6 RF-Sweep.....	2.220
2.19.7 LEVEL Sweep.....	2.222
2.19.8 LF-Sweep.....	2.223
2.20 LIST Mode	2.225
2.20.1 Operating Modes (MODE).....	2.225
2.20.2 Inputs/Outputs.....	2.226
2.21 Memory Sequence	2.230
2.22 Utilities	2.234
2.22.1 IEC-Bus Address (SYSTEM-GPIB).....	2.234
2.22.2 Parameter of the RS232 Interface (SYSTEM-RS232).....	2.235
2.22.3 Parameter of the SER DATA Input (SYSTEM-SERDATA).....	2.236
2.22.4 Suppressing Indications and Deleting Memories (SYSTEM-SECURITY).....	2.237
2.22.5 Indication of the IEC-Bus Language (LANGUAGE).....	2.238
2.22.6 Reference Frequency Internal/External (REF OSC).....	2.238
2.22.7 Phase of the Output Signal (PHASE).....	2.239
2.22.8 Password Input With Functions Protected (PROTECT).....	2.240
2.22.9 Calibration (CALIB).....	2.241
2.22.10 Indications of Module Variants (DIAG-CONFIG).....	2.248
2.22.11 Voltage Indication of Test Points (DIAG-TPOINT).....	2.249
2.22.12 Indications of Service Data (DIAG-PARAM).....	2.250
2.22.13 Test (TEST).....	2.250
2.22.14 Assigning Modulations to the [MOD ON/OFF] Key (MOD-KEY).....	2.251
2.22.15 Setting Auxiliary Inputs/Outputs (AUX-I / O).....	2.252
2.22.16 Switching On/Off Beeper (BEEPER).....	2.253
2.22.17 Installation of Software Option.....	2.254
2.23 The Help System	2.255
2.24 Status	2.255
2.25 Error Messages	2.256

3 Remote Control

3.1 Brief Instructions	3.1
3.1.1 IEC-Bus	3.1
3.1.2 RS-232 Interface	3.2
3.2 Switchover to Remote Control	3.2
3.2.1 Remote Control via IEC Bus.....	3.3
3.2.1.1 Setting the Device Address.....	3.3
3.2.1.2 Indications during Remote Control	3.3
3.2.1.3 Return to Manual Operation.....	3.3
3.2.2 Remote Control via RS-232-Interface	3.4
3.2.2.1 Setting the Transmission Parameters	3.4
3.2.2.2 Indications during Remote Control	3.4
3.2.2.3 Return to Manual Operating.....	3.4
3.3 Messages.....	3.4
3.3.1 Interface Message	3.4
3.3.2 Device Messages (Commands and Device Responses)	3.5
3.4 Structure and Syntax of the Device Messages	3.5
3.4.1 SCPI Introduction.....	3.5
3.4.2 Structure of a Command	3.6
3.4.3 Structure of a Command Line.....	3.8
3.4.4 Responses to Queries	3.8
3.4.5 Parameter	3.9
3.4.6 Overview of Syntax Elements.....	3.11
3.5 Description of Commands	3.12
3.5.1 Notation	3.12
3.5.2 Common Commands	3.14
3.5.3 ABORt System.....	3.17
3.5.4 CALibration-System	3.18
3.5.5 DIAGnostic-System	3.21
3.5.6 DISPLAY-System	3.23
3.5.7 FORMat-System.....	3.24
3.5.8 MEMory System	3.25
3.5.9 OUTPut-System	3.25
3.5.10 OUTPut2 System.....	3.28
3.5.11 SOURce-System	3.29
3.5.11.1 SOURce:AM Subsystem	3.30
3.5.11.2 SOURce:CORRection Subsystem.....	3.31
3.5.11.3 SOURce:DECT-Subsystem (Digital Standard).....	3.33
3.5.11.4 SOURce:DM Subsystem	3.41
Vector Modulation.....	3.41
Digital Modulation	3.43
3.5.11.5 SOURce:FM Subsystem.....	3.54
3.5.11.6 SOURce:FREQUency Subsystem	3.56
3.5.11.7 SOURce:FSIM -Subsystem	3.59
3.5.11.8 SOURce:GSM Subsystem (Digital Standard).....	3.64
3.5.11.9 SOURce:IS95 Subsystem (Digital Standard IS-95/CDMA)	3.71
3.5.11.10 SOURce:LIST Subsystem	3.79
3.5.11.11 SOURce:MARKer Subsystem	3.82
3.5.11.12 SOURce:NADC Subsystem (Digital Standard).....	3.84
3.5.11.13 SOURce:PDC Subsystem (Digital Standard)	3.92

3.5.11.14 SOURce:PHASe Subsystem	3.102
3.5.11.15 SOURce:PHS Subsystem (Digital Standard)	3.103
3.5.11.16 SOURce:PM Subsystem	3.111
3.5.11.17 SOURce:POWer Subsystem	3.113
3.5.11.18 SOURce:PULM Subsystem	3.116
3.5.11.19 SOURce:ROSCillator Subsystem	3.117
3.5.11.20 SOURce:SWEep Subsystem	3.118
3.5.12 SOURce2 System	3.121
3.5.12.1 SOURce2:FREQUency Subsystem	3.121
3.5.12.2 SOURce2:MARKer-Subsystem	3.123
3.5.12.3 SOURce2:SWEep-Subsystem	3.124
3.5.13 STATus-System	3.126
3.5.14 SYSTem-System	3.128
3.5.15 TEST-System	3.134
3.5.16 TRIGger-System	3.136
3.5.17 UNIT-System	3.139
3.6 Instrument Model and Command Processing	3.140
3.6.1 Input Unit	3.140
3.6.2 Command Recognition	3.141
3.6.3 Data Set and Instrument Hardware	3.141
3.6.4 Status Reporting System	3.141
3.6.5 Output Unit	3.142
3.6.6 Command Sequence and Command Synchronization	3.142
3.7 Status Reporting System	3.143
3.7.1 Structure of an SCPI Status Register	3.143
3.7.2 Overview of the Status Registers	3.145
3.7.3 Description of the Status Registers	3.146
3.7.3.1 Status Byte (STB) and Service Request Enable Register (SRE)	3.146
3.7.3.2 IST Flag and Parallel Poll Enable Register (PPE)	3.147
3.7.3.3 Event Status Register (ESR) and Event Status Enable Register (ESE)	3.147
3.7.3.4 STATus:OPERation Register	3.148
3.7.3.5 STATus:QUESTionable Register	3.149
3.7.4 Application of the Status Reporting Systems	3.150
3.7.4.1 Service Request, Making Use of the Hierarchy Structure	3.150
3.7.4.2 Serial Poll	3.150
3.7.4.3 Parallel Poll	3.151
3.7.4.4 Query by Means of Commands	3.151
3.7.4.5 Error Queue Query	3.151
3.7.5 Resetting Values of the Status Reporting Systems	3.152
3.8 Fast Restore Mode	3.153

4 Maintenance and Troubleshooting

4.1 Maintenance	4.1
4.1.1 Cleaning the Outside	4.1
4.1.2 Storage	4.1
4.2 Functional Test	4.1

5 Performance Test

5.1 Test Utilities and Test Systems	5.1
5.1.1 Test Instruments and Utilities	5.1
5.1.2 Test Systems	5.2
5.1.2.1 Standard Test System for Analog Modulations	5.2
5.1.2.2 Test System for Analog Modulations with Audio Analyzer.....	5.2
5.1.2.3 Test System for Broadband FM.....	5.4
5.1.2.4 Test System for Pulse Modulation	5.4
5.1.2.5 Test System for Vector Modulation.....	5.5
5.1.2.6 Test System for Settling Time.....	5.5
5.1.2.7 Test System for SSB Phase Noise	5.6
5.1.2.8 Test System for Output Impedance (VSWR)	5.6
5.1.2.9 5.6	
5.1.2.10 Test System with Sampling Oscilloscope for Fading Simulation	5.7
5.2 Preparation and Sampling Frequencies	5.8
5.3 Performance Test	5.9
5.3.1 Display and Keyboard.....	5.9
5.3.2 Frequency.....	5.9
5.3.2.1 Frequency Setting	5.9
5.3.2.2 Settling Time	5.10
5.3.3 Reference Frequency	5.11
5.3.4 Spectral Purity	5.12
5.3.4.1 Harmonics Suppression/Harmonics	5.12
5.3.4.2 Suppression of Nonharmonics.....	5.12
5.3.4.3 SSB Phase Noise	5.16
5.3.4.4 Broadband Noise	5.17
5.3.4.5 Residual FM.....	5.18
5.3.4.6 Residual AM.....	5.18
5.3.5 Level	5.18
5.3.5.1 Level Frequency Response and Linearity.....	5.18
5.3.5.2 Settling Time	5.20
5.3.5.3 Output Impedance	5.21
5.3.5.4 Non-interrupting Level Setting (ATTENUATOR MODE FIXED)	5.23
5.3.5.5 Overvoltage Protection	5.23
5.3.6 Internal Modulation Generator	5.24
5.3.7 Amplitude Modulation	5.25
5.3.7.1 Modulation Depth Setting.....	5.25
5.3.7.2 AM Frequency Response	5.25
5.3.7.3 AM Distortion Factor	5.26
5.3.7.4 Residual PhiM with AM	5.26
5.3.7.5 Level Monitoring at Input EXT1.....	5.26
5.3.8 Broadband Amplitude Modulation.....	5.27
5.3.9 Pulse Modulation (only with IQMOD Rev. >2)	5.27
5.3.9.1 ON/OFF Ratio	5.27
5.3.9.2 Dynamic Characteristics	5.28
5.3.10 Vector Modulation.....	5.28
5.3.15.1 Maximum Level.....	5.28
5.3.15.2 Input Impedance (VSWR).....	5.29
5.3.15.3 Vector Error	5.29
5.3.15.4 Modulation Frequency Response	5.30
5.3.15.5 Residual Carrier	5.31
5.3.15.6 IQ Imbalance	5.31
5.3.15.7 Level Control POW RAMP.....	5.32

5.3.11 Frequency Modulation (Option FM Modulator)	5.34
5.3.11.1 FM Deviation Setting	5.34
5.3.11.2 FM Frequency Response	5.34
5.3.11.3 FM Distortion Factor	5.35
5.3.11.5 Residual AM with FM	5.36
5.3.11.6 Carrier Frequency Deviation with FM	5.37
5.3.11.7 Level Monitoring at Input EXT2	5.37
5.3.12 Phase Modulation (Option PM Modulator)	5.37
5.3.12.1 Deviation Setting	5.37
5.3.12.2 5.38	
5.3.12.3 PhiM Distortion Factor	5.38
5.3.13 Digital Modulation (Option SMIQB10)	5.39
5.3.13.1 Deviation Error for GFSK	5.39
5.3.13.2 Phase Error for GMSK	5.39
5.3.13.3 Error Vector for DQPSK	5.40
5.3.13.4 Error Vector for PHS	5.41
5.3.13.5 Error Vector for NADC	5.41
5.3.13.6 Error Vector for PDC	5.41
5.3.13.7 Phase Error for GSM	5.42
5.3.14 Rho Factor for Digital Standard IS-95 CDMA (Option SMIQB42)	5.42
5.3.15 5.43	
5.3.15.1 5.43	
5.3.15.2 5.43	
5.3.15.3 5.43	
5.3.15.4 5.43	
5.3.15.5 5.43	
5.3.16 Fading Simulation	5.44
5.3.16.1 Frequency Response	5.44
5.3.16.2 Level Error	5.45
5.3.16.3 Path Attenuation	5.46
5.3.16.4 Path Delay	5.47
5.3.16.5 Doppler Shift	5.48
5.4 Performance Test Protocol	5.49

6 Annex A - Interfaces

IEC/IEEE Bus Interface	6A.1
RS-232-C Interface	6A.4
Asynchronous Interface SERDATA	6A.7

7 Annex B - List of Error Messages

SCPI-Specific Error Messages	7B.1
SMIQ-Specific Error Messages	7B.6

8 Annex C - List of Commands

9 Annex D - Programming Examples

10 Index

Tables

Table 2-1 Input sockets for the different types of modulation	2.54
Table 2-2 Status messages (deviation from the rated value at EXT1 and EXT2)	2.55
Table 2-3 Parameter setting ranges	2.67
Table 2-4 Phase shifts for $\pi/4$ DQPSK without coding	2.78
Table 2-5 Phase shifts for $\pi/4$ DQPSK with coding NADC, PDC, PHS, TETRA or APCO25	2.78
Table 2-6 Phase shifts for $\pi/4$ DQPSK with coding TFTS	2.78
Table 2-7 Frequency deviations for FSK methods	2.79
Table 2-8 Possible combination of modulation method and coding	2.79
Table 2-9 Coding algorithms	2.80
Table 2-10 Examples of settings conflicts	2.81
Table 2-11 PRBS generators of modulation coder	2.84
Table 2-12 Logic function of signals BURST GATE and LEVEL ATT	2.89
Table 2-13 PRBS generators for PHS	2.106
Table 2-14 CDMA: channel numbers and their frequencies	2.120
Table 2-15 Preferred CDMA-frequency channels according to J-STD-008	2.120
Table 2-17 PRBS generators for NADC	2.139
Table 2-18 PRBS generators for PDC	2.157
Table 2-19 PRBS generators for GSM	2.179
Table 2-20 PRBS generators for DECT	2.193
Table 2-21 LIST mode; Example of a list	2.225
Table 2-22 MEMORY SEQUENCE; Example of a list	2.230
Table 3-1 Common Commands	3.14
Table 3-2 Device Response to *OPT?	3.15
Table 3-3 Synchronization with *OPC, *OPC? and *WAI	3.142
Table 3-4 Meaning of the bits used in the status byte	3.146
Table 3-5 Meaning of the bits used in the event status register	3.147
Table 3-6 Meaning of the bits used in the STATus:OPERation register	3.148
Table 3-7 Meaning of the bits used in the STATus:QUESTionable register	3.149
Table 3-8 Resetting instrument functions	3.152
Table 5-1 Test instruments and utilities	5.1
Table 5-2 Sampling frequencies of the internal calibrations	5.8
Table A-1 Interface function	6A.2
Table A-2 Universal Commands	6A.3
Table A-3 Addressed Commands	6A.3
Table A-4 Interface functions (RS-232-C)	6A.5

Figures

Fig. 1-1 SMIQ, View from the top..... 1.5

Fig. 2-1 Front panel view..... 2.2

Fig. 2-2 Rear panel view 2.12

Fig. 2-3 Design of the display..... 2.22

Fig. 2-4 MODULATION-AM menu 2.23

Fig. 2-5 Display after AM setting 2.29

Fig. 2-6 Display after pattern setting 2.31

Fig. 2-7 OPERATION page of the MEM SEQ menu..... 2.32

Fig. 2-8 SELECT-LIST-selection window..... 2.33

Fig. 2-9 DELETE-LIST selection window..... 2.34

Fig. 2-10 Edit function EDIT/VIEW..... 2.35

Fig. 2-11 Block function FILL: Input window 2.36

Fig. 2-12 Edit function INSERT: Input window 2.38

Fig. 2-13 Edit function DELETE: Input window 2.39

Fig. 2-14 Starting point of the pattern setting 2.40

Fig. 2-15 Pattern setting - Edition of a list 2.42

Fig. 2-16 Menu FREQUENCY 2.45

Fig. 2-17 Example of a circuit with frequency offset 2.46

Fig. 2-18 Menu LEVEL..... 2.47

Fig. 2-19 Example of a circuit with level offset..... 2.49

Fig. 2-20 Menu LEVEL - ALC 2.50

Fig. 2-21 Menu LEVEL - UCOR - OPERATION side..... 2.51

Fig. 2-22 Menu UCOR - LEVEL-EDIT side..... 2.52

Fig. 2-23 Menu LEVEL-EMF 2.53

Fig. 2-24 Example: Status message "EXT1-LOW" in case of voltage at EXT1 too low. 2.55

Fig. 2-25 Example: Settings of the LF generator in the AM menu..... 2.57

Fig. 2-26 Menu ANALOG MOD-AM 2.58

Fig 2-27 Menu ANALOG MOD - BB-AM 2.59

Fig. 2-28 Menu ANALOG MOD-FM..... 2.60

Fig. 2-29 Dependency of the FM maximal deviation on the RF frequency set 2.61

Fig. 2-30 Menu ANALOG MOD - PM 2.62

Fig. 2-31 Dependency of the PM maximal deviation on the RF frequency set 2.63

Fig. 2-32 Menu MODULATION-PULSE..... 2.64

Fig. 2-33 Example: vector modulation 2.65

Fig. 2-34 VECTOR MOD menu 2.66

Fig. 2-35 Effect of I/Q impairment..... 2.67

Fig. 2-36 Fading simulator in the SMIQ 2.68

Fig. 2-37 Two-channel fading..... 2.69

Fig. 2-38 Menu FADING SIM..... 2.71

Fig. 2-39 Doppler Frequency shift with moving receiver 2.73

Fig. 2-40 Modulation coder in SMIQ 2.76

Fig. 2-41 Digital input signals of modulation coder 2.76

Fig. 2-42 Functional blocks Coding and Mapping..... 2.76

Fig. 2-43 Constellation diagrams of BPSK, QPSK, 8PSK and 16QAM 2.77

Fig. 2-44 DATA LIST for modulation data.....	2.82
Fig. 2-45 CONTROL LIST for control signals	2.83
Fig. 2-46 9-bit PRBS generator.....	2.84
Fig. 2-47 External serial data and bit clock.....	2.86
Fig. 2-48 External serial data and symbol clock, 3 bit/symbol.....	2.86
Fig. 2-49 External serial data, internal clock signals.....	2.86
Fig. 2-50 External parallel data and symbol clock.....	2.87
Fig. 2-51 External parallel data and symbol clock. SYMBOL CLOCK = High marks the LSB.....	2.87
Fig. 2-52 Envelope control in SMIQ with modulation coder	2.89
Fig. 2-53 Signal waveforms during envelope control	2.90
Fig. 2-54 DIGITAL MOD menu	2.91
Fig. 2-55 DIGITAL MOD-SOURCE menu.....	2.91
Fig. 2-56 DIGITAL MOD - MODULATION... menu.....	2.94
Fig. 2-57 DIGITAL MOD -FILTER... menu.....	2.96
Fig. 2-58 DIGITAL MOD - TRIGGER menu.....	2.98
Fig. 2-59 DIGITAL MOD - CLOCK.....	2.100
Fig. 2-60 DIGITAL MOD - POWER RAMP CONTROL menu	2.101
Fig. 2-61 DIGITAL MOD - EXT INPUTS menu.....	2.103
Fig. 2-62 Menu DIGITAL STD - PHS	2.108
Fig. 2-63 Menu DIGITAL STD - PHS - MODULATION.....	2.108
Fig. 2-64 Menu DIGITAL STD - PHS_TRIGGER.....	2.110
Fig. 2-65 Menu DIGITAL STD - PHS - CLOCK... ..	2.112
Fig. 2-66 Menu DIGITAL STD - PHS - POWER RAMP CONTROL... ..	2.113
Fig. 2-67 Menu DIGITAL STD - PHS - SAVE/RCL FRAME	2.114
Fig. 2-68 Menu DIGITAL STD - PHS - SELECT SLOT	2.115
Fig. 2-69 Forward link signal generation	2.118
Fig. 2-70 Reverse link signal generation without channel coding	2.119
Fig. 2-71 Traffic channel 9600 in "Reverse Link Coded" mode	2.119
Fig. 2-72 Frame structure of traffic channel 9600 in "Reverse Link Coded" mode.....	2.119
Fig. 2-73 CDMA sync signals.....	2.121
Fig. 2-74 Menu DIGITAL STD - IS-95 - MODE - FWD_LINK_18	2.124
Fig. 2-75 Menu DIGITAL STD - IS-95 - MODULATION... ..	2.126
Fig. 2-76 Menu DIGITAL STD - IS-95 - TRIGGER... ..	2.128
Fig. 2-77 Menu DIGITAL STD - IS-95 - CLOCK... ..	2.130
Fig. 2-78 Menu DIGITAL STD - IS-95 - SAVE/RCL MAPPING... ..	2.132
Fig. 2-79 Menu DIGITAL STD - IS-95 - MODE - REV_LINK	2.134
Fig. 2-81 Menu DIGITAL STD - NADC	2.141
Fig. 2-82 Menu DIGITAL STD - NADC - MODULATION.....	2.141
Fig. 2-83 Menu DIGITAL STD - NADC_TRIGGER.....	2.143
Fig. 2-84 Menu DIGITAL STD - NADC - CLOCK.....	2.144
Fig. 2-85 Menu DIGITAL STD - NADC - POWER RAMP CONTROL... ..	2.145
Fig. 2-86 Menu DIGITAL STD - NADC - SAVE/RCL FRAME.....	2.147
Fig. 2-87 Menu DIGITAL STD - NADC - SELECT SLOT, LINK DIRECTION = DOWNLINK.....	2.148
Fig. 2-88 Menu DIGITAL STD - NADC - SELECT SLOT, LINK DIRECTION = UPLINK	2.151
Fig. 2-89 Menu DIGITAL STD - NADC - SELECT SLOT	2.153
Fig. 2-90 Menu DIGITAL STD - PDC.....	2.159
Fig. 2-91 Menu DIGITAL STD - PDC - MODULATION... ..	2.159

Fig. 2-92 Menu DIGITAL STD - PDC_TRIGGER.....	2.161
Fig. 2-93 Menu DIGITAL STD - PDC - CLOCK.....	2.162
Fig. 2-94 Menu DIGITAL STD - PDC - POWER RAMP CONTROL.....	2.163
Fig. 2-95 Menu DIGITAL STD - PDC - SAVE/RCL FRAME	2.164
Fig. 2-96 Menu DIGITAL STD - PDC - SELECT SLOT, LINK DIRECTION = DOWNLINK	2.166
Fig. 2-97 Menu DIGITAL STD - PDC - SELECT SLOT, LINK DIRECTION = DOWNLINK	2.170
Fig. 2-98 Menu DIGITAL STD - PDC - SELECT SLOT, LINK DIRECTION = DOWNLINK	2.172
Fig. 2-99 Menu DIGITAL STD - PDC - SELECT SLOT	2.174
Fig. 2-100 Menu DIGITAL STD - GSM	2.181
Fig. 2-101 Menu DIGITAL STD - GSM - MODULATION.....	2.181
Fig. 2-102 Menu DIGITAL STD - GSM_TRIGGER.....	2.183
Fig. 2-103 Menu DIGITAL STD - GSM - CLOCK.....	2.184
Fig. 2-104 Menu DIGITAL STD - GSM - POWER RAMP CONTROL... ..	2.185
Fig. 2-105 Menu DIGITAL STD - GSM - SAVE/RCL FRAME.....	2.186
Fig. 2-106 Menu DIGITAL STD - GSM - SELECT SLOT	2.187
Fig. 2-107 Menu DIGITAL STD - GSM - SELECT SLOT	2.189
Fig. 2-108 Menu DIGITAL STD - GSM - SELECT SLOT	2.190
Fig. 2-109 Menu DIGITAL STD - DECT.....	2.195
Fig. 2-110 Menu DIGITAL STD - DECT - MODULATION.....	2.195
Fig. 2-111 Menu DIGITAL STD - DECT_TRIGGER.....	2.197
Fig. 2-112 Menu DIGITAL STD - DECT - CLOCK.....	2.199
Fig. 2-113 Menu DIGITAL STD - DECT - POWER RAMP CONTROL... ..	2.200
Fig. 2-114 Menu DIGITAL STD - DECT - SAVE/RCL FRAME	2.202
Fig. 2-115 Menu DIGITAL STD - DECT - SELECT SLOT.....	2.203
Fig. 2-116 Vector modulation with an external AMIQ.....	2.207
Fig. 2-117 Menu AMIQ CTRL	2.208
Fig. 2-118 Menu AMIQ CTRL -SETUP.....	2.208
Fig. 2-119 Menu AMIQ CTRL -SAVE/RECALL SETTINGS... ..	2.210
Fig. 2-120 Menu AMIQ - SELECT WAVEFORM/EXECUTE BATCH.....	2.211
Fig. 2-121 Menu AMIQ CTRL -LEVEL.....	2.213
Fig. 2-122 Menu AMIQ CTRL - MARKER.....	2.214
Fig. 2-123 Menu LF OUTPUT	2.215
Fig. 2-124 Signal example sweep: MODE = AUTO, BLANK TIME = NORMAL	2.219
Fig. 2-125 Signal example sweep: MODE = SINGLE, BLANK TIME = LONG	2.219
Fig. 2-126 Menu SWEEP - FREQ.....	2.220
Fig. 2-127 Menu SWEEP - LEVEL	2.222
Fig. 2-128 Menu SWEEP - LF GEN.....	2.223
Fig. 2-129 Signal example LIST mode: MODE = EXT-STEP	2.227
Fig. 2-130 Menu LIST - OPERATION page.....	2.227
Fig. 2-131 Menu List - EDIT page.....	2.229
Fig. 2-132 Menu MEM SEQ -OPERATION-page	2.232
Fig. 2-133 Menu MEM SEQ - EDIT page.....	2.233
Fig. 2-134 Menu UTILITIES -SYSTEM -GPIB	2.234
Fig. 2-135 Menu UTILITIES - SYSTEM - RS232.....	2.235
Fig. 2-136 Menu UTILITIES - SYSTEM - SERDATA.....	2.236
Fig. 2-137 Menu UTILITIES - SYSTEM-SECURITY.....	2.237
Fig. 2-138 Menu UTILITIES - REF OSC	2.238

Fig. 2-139 Menu UTILITIES - PHASE	2.239
Fig. 2-140 Menu UTILITIES - PROTECT	2.240
Fig. 2-142 Menu UTILITIES - CALIB - VCO SUM	2.242
Fig. 2-143 Menu UTILITIES - CALIB - VECTOR MOD menu.....	2.243
Fig. 2-144 Menu UTILITIES - CALIB - LEV PRESET	2.244
Fig. 2-145 Menu UTILITIES - CALIB - ALC TABLE.....	2.245
Fig. 2-146 Menu UTILITIES - CALIB - LEV ATT.....	2.246
Fig. 2-147 Menu UTILITIES - CALIB - FADING SIM	2.247
Fig. 2-148 Menu UTILITIES - DIAG - CONFIG.....	2.248
Fig. 2-149 Menu UTILITIES - DIAG - TPOINT	2.249
Fig. 2-150 Menu UTILITIES - DIAG - PARAM	2.250
Fig. 2-151 Menu UTILITIES - MOD KEY	2.251
Fig. 2-152 Menu UTILITIES - AUX I/O.....	2.252
Fig. 2-153 Menu UTILITIES - BEEPER	2.253
Fig. 2-154 Menu UTILITIES - INSTALL	2.254
Fig. 2-155 Menu STATUS page.....	2.255
Fig. 2-156 ERROR page.....	2.256
Fig. 3-1 Tree structure of the SCPI command systems.....	3.6
Fig. 3-2 Instrument model in the case of remote control by means of the IEC bus	3.140
Fig. 3-3 The status -register model.....	3.143
Fig. 3-4 Overview of the status register	3.145
Fig 4-1 UTILITIES-TEST menu	4.2
Fig. A-1 Contact Assigment of the IEC-bus socket.....	0.1
Fig. A-2 Pin assigment of RS-232-C connector	0.4
Fig. A-3 Wiring of data, control and signalling lines for hardware handshake	0.6

5

6

7

8

1 Preparation for Use

1.1 Putting into Operation

Before putting the SMIQ into operation, please make sure that

- the covers of the casing are put on and screwed,
- the ventilation openings are free,
- no signal voltage levels exceeding the permissible limits are applied at the inputs,
- the outputs of the instrument are not overloaded or connected incorrectly.

If these points are not observed, the instrument might be damaged.

1.1.1 Supply Voltage

The SMIQ can be operated at a.c. systems from 90 to 132 V and 180 to 265 V at system frequencies from 47 to 440 Hz. The power supply socket is situated at the rear of the instrument. The instrument automatically sets itself to the voltage applied within the permissible voltage ranges. It is not necessary to set the instrument to a certain supply voltage.

1.1.2 Switching On/Off the Instrument

Power switch at the rear of the instrument

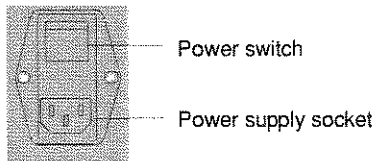

Switch on/off: ➤ Press power switch at the top (I) / bottom (O)
The power switch can remain switched on permanently. Switching off is only necessary when the instrument is to be completely disconnected from the mains.

On/off switch at the front of the instrument



Switch on: ➤ Press switch.
The instrument is ready for operation.

Switch off: ➤ Release switch.
The instrument assumes the STANDBY mode.

1.1.3 Initial Status

Upon switching on, the instrument either automatically assumes the status which was set when it was switched off (parameter POWER-ON STATE PREVIOUS SETTING in LEVEL-LEVEL menu) or the RF output is disconnected (POWER-ON STATE RF OFF).

If the instrument need not to be operated from the initial status any further, a defined default status should be established by pressing the [PRESET] key prior to further settings.

STANDBY Mode

In the STANDBY mode the optional reference oscillator (option SM-B1) remains switched on, which increases frequency accuracy.

Frequency accuracy after switching on when the oven-controlled reference oscillator is fitted (option SM-B1)

When switching on from the STANDBY mode, the specified frequency accuracy is reached immediately. If the power switch was switched off, the reference oscillator needs some minutes of warm-up time to reach its nominal frequency. During this period of time, the output frequency does not yet reach its final value either. In the status line in the header field of the display the message "OVEN COLD" is displayed for this time.

1.1.4 Setting Contrast and Brightness of the Display

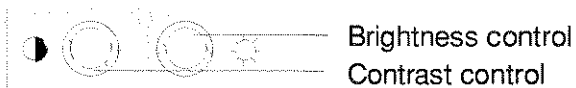

Contrast and brightness of the display can be set by means of the contrast and brightness controls situated below the display.

1.1.5 RAM With Battery Back-Up

The SMIQ has a static read-write memory (CMOS-RAM) with battery back-up, in which 50 different complete settings of the instrument can be stored (cf. Chapter 2, section "Storing and Calling of Instrument Settings"). In addition, all data and/or lists the user enters himself, such as for list mode, memory sequence, and user correction of the level, are stored in the RAM. Further, all data of the calibrations running within the instrument in the SMIQ are stored in the RAM (cf. Chapter 2, section "Calibration").

A lithium battery with a service life of approx. 5 years serves to supply the RAM with power. When the battery is discharged, the data stored will be lost. For exchange of the battery see Service Manual (Id-No.: 1085.2445.24).

1.1.6 Preset Setting

A defined setting status is achieved by pressing the [PRESET] key.

Preset Status:

RF frequency	100 MHz
RF level	-30 dBm
Reference frequency	internal, adjustment off
Offsets	0
Modulations	switched off
Transient-free level setting	switched off, level attenuator mode: AUTO
Internal level control	level ALC: AUTO
User correction	level UCOR: OFF
LF output	switched off
Sweep	switched off
List mode	switched off
Memory sequence	switched off
Suppression of indications	system security: unaltered
Protection of calibration data	protection lock: unaltered
Settings stored	unaltered
Data, lists etc. stored	unaltered
IEC-bus address	unaltered
Beeper	unaltered

All parameters and circuit states, even those of operating modes which are not activated, are preset by means of Preset.

The presettings going beyond the above list can be seen from the menu representations as of Section 2.4 which each indicate the Preset setting status.

1.2 Functional Test

On switching on the instrument and permanently during operation, the SMIQ carries out a self test. The ROM contents as well as the battery of the non-volatile RAM are checked on switching on the instrument and the RAM contents with every calling the memory. The most important instrument functions are automatically monitored during operation.

If an error is detected, the message "ERROR" is displayed in the status line. For further identification of the error, press the [ERROR] key. Thereupon a description of the error/s is displayed (cf. Chapter 2, section "Error Messages"). Return to the menu exited by pressing the [RETURN] key.

If required, the self tests can be induced purposefully. See Chapter 4, section "Functional Test". Further, internal test points can be polled by the user and the results be read out and displayed. See Chapter 2, section "Voltage Indication of Test Points".

1.3 Fitting the Options

Due to its variety of options, the SMIQ offers the possibility of providing the instrument with the equipment exactly corresponding to the application. Newly fitted options are automatically recognized and the relevant parameters added in the menu.

After every change of the instrument configuration, the CMOS RAM has to be cleared as the storage data shift:

- Switch off the instrument
- Switch the instrument on again with the [RESET] key pressed

The internal calibration routines VECTOR MOD, VCO SUM, and LEV PRESET now have to be called up again to restore the cleared calibration values.

These routines are accessible via menu UTILITIES-CALIB (see also Chapter 2, section "calibration"). The calibration routines have to be carried out in the following order:

1. Summing loop (VCO SUM)
2. VECTOR MOD
3. LEV PRESET

1.3.1 Opening the Casing



Caution:

Prior to opening the SMIQ unplug the power connector.

Remove paneling

- Remove four screws in the two tilt feet at the rear of the instrument.
- Remove the upper paneling towards the top and rear.
- Turn the instrument.
- Remove the lower paneling towards the top and rear.

Open ventilation ducts

When an option is fitted at a slot which has not been used up to now, the appropriate ventilation duct of the plexiglas plate at the left in the casing frame must be opened. The openings are pre-punched so that the respective part is easy to break out.

1.3.2 Overview of the Slots

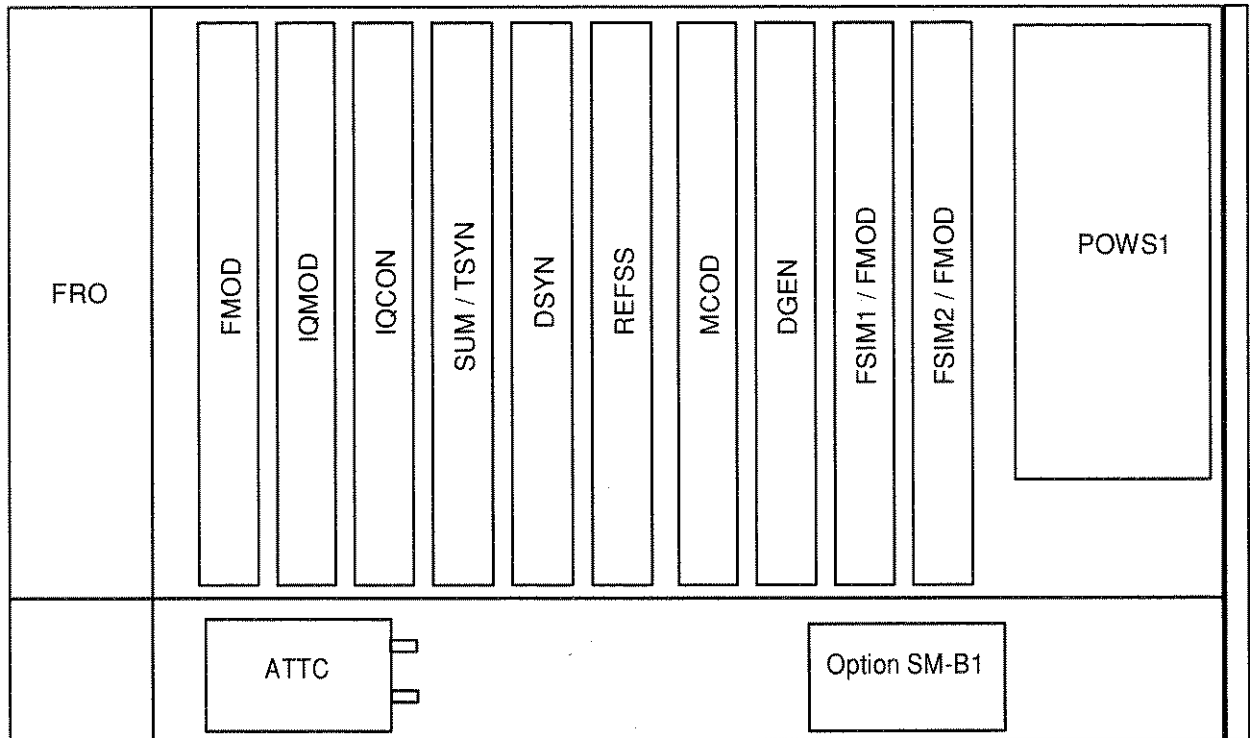

FRO = front unit
 FMOD = FM/PM modulator
 IQMOD = I/Q modulator
 IQCON = I/Q converter
 SUM = summing loop
 DSYN = digital synthesis

REFSS = reference/step synthesis
 MCODE = modulation coder
 DGEN = data generator
 FSIM = fading simulator
 POWS1 = power supply
 ATTC = attenuator

Fig. 1-1 SMIQ, View from the top

1.3.3 Option SM-B1 - Reference Oscillator OCXO

Fitting the option

- Fasten the option at the back end of the lateral opening by means of the screw threads provided there.
- If the two last slots are both occupied, one of these modules must be removed temporarily.
- Feed ribbon cable W710 through the rear square cut-out to the motherboard, insert into connector X22 and snap in the locking.
- Feed coaxial cable W710 from socket X711 of the option through the second cut-out along the rear transverse panel to connector X74 at the A7 module, reference/step synthesis, via the motherboard and insert there. Fasten the cable at the transverse panel using the cable ties attached.

Set tuning voltage and calibrate OCXO

The crystal oscillator was factory-tuned to nominal frequency and the appropriate tuning voltage indicated on the cover of the module. The calibration value now has to be calculated from this value and transferred to the memory of the signal generator.

Calculate calibration value

The tuning voltage is generated by a 12b-bit-D/A converter which is scaled such that a tuning voltage of 12 volts is generated with calibration value (CALIBRATION DATA) 4000. The calibration value is thus calculated from the tuning voltage (V_{tun}) as follows

$$CALIBRATION\ DATA = V_{tun} \times 4000 / 12$$

For checking purposes, the voltage at pin 16 of plug X22 on the motherboard can be remeasured and corrected if necessary. A check by means of frequency measurement may only be made after a warm-up of 2 hours and against a calibrated reference.

Store calibration value

- Unlock protection level 2 with code 250751.
- v Call menu UTILITIES-CALIB-REF OSC.
- Enter the calculated calibration voltage with CALIBRATION DATA by means of the rotary knob or keypad.
- Select STORE CALIBRATION DATA
- Terminate entry using the [SELECT] key
The new calibration value is stored in the EPROM.

Note: The flash EPROM does not permit the deletion of individual data. Thus new memory space is occupied for each calibration. If there is no memory space available any more, the EPROM must be cleared by an authorized service shop and be written into anew. Thus a calibration should only be made if necessary

1.3.4 Option SM-B5 - FM/PM Modulator

The FM/PM modulator is fitted at the slot with label 'FMOD'.

Fitting the option

- Withdraw cable W89 from X99 of the summing loop and use again.
- Establish the following connections:

Cable	From	To	Signal
W89	A8-X89	A6-X67	FDSYN
W65	A6-X65	A7-X71	REF100
W67	A6-X69	A9-X99	FDFM

1.3.5 Option SMIQB10 - Modulation Coder

The Modulation Coder is fitted at the slot with label "MCOD".

- Plug the module into the appropriate place, lock it and fasten all screws
- Open the air inlets at the housing frame by breaking out the safety glass plate which belongs to the option
- Depending on the fact whether the option SMIQB14 (FSIM 1) has been installed in the SMIQ, the following coaxial connections have to be made:

Note: Please store the remaining cables. They will be required if further options will be installed at a later stage or options will be removed.

		SMIQ without option FSIM 1		SMIQ with option FSIM 1		Remark about cable
Cable	from MCOOD	to		to		
W322	X321	REFSS	X72	REFSS	X72	W322 was provided with MCOOD.
W72	X322	DSYN	X81	DSYN	X81	Withdraw W72 from X72 of module REFSS.
W243	X323	BACK	POW RAMP socket	BACK	POW RAMP socket	Withdraw W243 from X243 of module IQMOD.
W324	X324	IQMOD	X243	IQMOD	X243	W324 was provided with MCOOD.
W325	X325	IQMOD	X244	-	-	W325 was provided with MCOOD.
W361	X325	-	-	FSIM 1	X361	W361 was provided with FSIM1.
	X326	-	-	-	-	-
W244	X327	FRO	I socket	FRO	I socket	Withdraw W244 from X244 of module IQMOD. If FSIM1 is installed withdraw W244 from X361 of module FSIM1.
W328	X328	IQMOD	X245	-	-	W328 was provided with MCOOD.
W363	X328	-	-	FSIM 1	X363	W363 was provided with FSIM1.
	X329	-	-	-	-	-
W245	X330	FRO	Q socket	FRO	Q socket	Withdraw W245 from X245 of module IQMOD. If FSIM1 is installed withdraw W245 from X363 of module FSIM1.

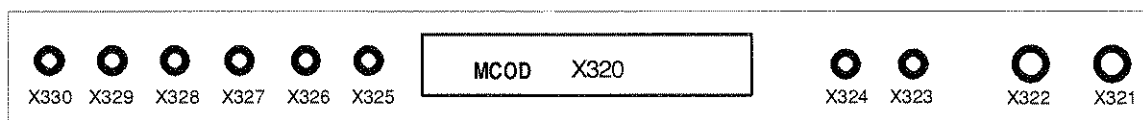

- The included adhesive label "Option included" is to be fixed at the rear panel of the SMIQ.

1.3.6 Option SMIQB11 - Data Generator

The Data Generator is fitted at the slot with label "DGEN".

- the module into the slot, lock it and fasten all screws
- Plug W341 onto X341
- Open the air inlets at the housing frame by breaking out the safety glass plate which belongs to the option

1.3.7 Option SMIQB12 - Memory Extension to Data Generator

The Data Generator can be upgraded with up to two memory extension units (SMIQB12). The first Memory Extension is fitted at the slot with label "X350", the second Memory Extension at slot with label "X351".

- Remove option Data Generator from SMIQ
- Withdraw the screws of the labelled screening cover and remove the cover.
- The first memory extension unit has to be plugged on connector X350 near the battery.
- The second memory extension unit has to be plugged on connector X351.
- Refit the screening cover of the Data Generator module.
- Plug the Data Generator back into the appropriate place, lock it and fasten all screws.

1.3.8 Option SMIQB42 - Digital Standard IS-95 CDMA

Option SMIQB42 is a software options. It can be enabled by a keyword. The keyword is printed on a label which is part of the equipment supplied and into the groof below the handle of SMIQ.

A prerequisite for installing the option is that option SMIQB10 (Modulation Coder) and SMIQB11 (Data Generator) are part of SME.

Enabling option

- Call up menu UTILITIES-INSTALL and then press key [SELECT].
- Select OPTION TO INSTALL and then press key [SELECT].
- Select option to be installed and then press key [SELECT].
- Enter the 6-digit keyword into the entry field INSTALLATION KEY and then press [ENTER]
- Switch off unit and then switch on again.

After installation, the new option can be checked in the module list in menu UTILITIES-DIAG-CONFIG.

1.3.9 Option SMIQB14 - Fading Simulator FSIM1

The Fading Simulator is fitted at the slot with label 'FSIM1'.

Before fitting the option SMIQB14 (FSIM1) first check the correct settings of the jumpers on the module. The jumper setting depends on the number of fading simulators installed, either one (FSIM1) or two (FSIM1 and FSIM2):

After an instrument warm-up period of 2 hours, the Fading Simulator as well as the IQ Modulator should be calibrated.

Two coaxial connecting cables (Stock No. 1085.4448.00) are part of the equipment supplied with the option. The cables can be connected to the outputs I₂/Q₂ of the AUX connector at the rear of SMIQ. I₂/Q₂ are the IQ output signals of the fading simulator.

Checking the jumper settings

Jumper Setting for the Fading Simulator FSIM1:
(Cf. labeling 'Jumper Setting' on the screening cover of the module)

FSIM1	Only one Fading Simulator installed			Two Fading Simulators installed		
	Jumper connects					
	X1.1	with	X1.2	X1.1	with	X1.2
	X8.1	with	X8.2	X8.2	with	X8.3
	X9.1	with	X9.2	X9.2	with	X9.3
	X12.2	with	X12.3	X12.2	with	X12.3
	X13.1	with	X13.2	X13.2	with	X13.3
	X15.1	with	X15.2	X15.1	with	X15.2
	X16.1	with	X16.2	X16.2	with	X16.3

Fitting the option

- Plug the module into the appropriate slot, lock it and fasten all screws.
- Open the air inlets at the housing frame by breaking out the safety glass plate which belongs to the option.
- Depending on the fact whether the option SMIQB10 (MCOB) has been installed in the SMIQ, the following coaxial connections have to be made:

Note: Please store the remaining cables. They will be required if further options will be installed at a later stage or options will be removed.

		SMIQ with option MCOD	SMIQ without option MCOD	Remark about cable
Cable	from FSIM1	to	to	
W361	X361	MCOD X325	-	W361 was provided with FSIM1
W244	X361	-	FRO I-Buchse	Withdraw W244 from X244 of module IQMOD
W363	X363	MCOD X328	-	W363 was provided with FSIM1
W245	X363	-	FRO Q-Buchse	Withdraw W245 from X245 of module IQMOD
W367	X367	IQMOD X244	IQMOD X244	W367 was provided with FSIM1
W388	X368	AUX I2	AUX I2	W388 was provided with FSIM1
W370	X370	IQMOD X245	IQMOD X245	W370 was provided with FSIM1
W391	X371	AUX Q2	AUX Q2	W391 was provided with FSIM1

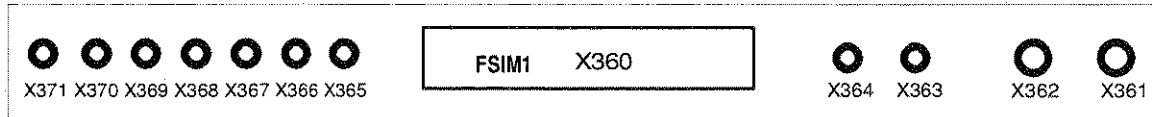

For further details on the connection of the AUX-socket at the rear panel of the SMIQ please refer to section 2.1.2. 'Elements at the rear panel'.

- The included adhesive label 'Option included' is to be fixed at the rear panel of the SMIQ.
- Warm-up the instrument for 2 hours.
- Call up menu UTILITIES - CALIB - FSIM
- Call up menu UTILITIES - CALIB - VECTOR MOD.

Calibrating the Fading Simulator and the I/Q Modulator

1.3.10 Option SMIQB15 - Second Fading Simulator (FSIM2)

The second Fading Simulator is fitted at the slot with label 'FSIM2'.

Before fitting the option SMIQB15 (FSIM2) please check the correct settings of the jumpers on both fading modules FSIM1 and FSIM2.

After an instrument warm-up period of 2 hours, the Fading Simulator as well as the IQ Modulator should be calibrated.

Checking the jumper settings

Jumper Setting for the Fading Simulator FSIM2:
(Cf. labeling 'Jumper Setting' on the screening cover of the module)

FSIM2			
Jumper connects	X1.2	with	X1.3
	X8.2	with	X8.3
	X9.2	with	X9.3
	X12.1	with	X12.2
	X13.2	with	X13.3
	X15.2	with	X15.3
	X16.2	with	X16.3

Fitting the option

- Plug the module into the appropriate slot for the FSIM2, lock it and fasten all screws.
- Open the air inlets at the housing frame by breaking out the safety glass plate which belongs to the option.
- The following coaxial connections have to be made:

Note: *Please store the remaining cables. They will be required if further options will be installed at a later stage or options will be removed.*

Cable	from FSIM2	to	
W362	X361	FSIM1	X362
W364	X363	FSIM1	X364
W365	X365	FSIM1	X365
W366	X367	FSIM1	X366
W369	X370	FSIM1	X369

- The included adhesive label 'Option included' is to be fixed at the rear panel of the SMIQ.

Calibrating the Fading Simulator and the I/Q Modulators

- Warm-up the instrument for 2 hours.
- Call up menu UTILITIES - CALIB - FSIM.
- Call up menu UTILITIES - CALIB - VECTOR MOD

Retrofit for 2-channel fading

- Cables W388 and W391 have to be repositioned for 2-channel fading.
- Unplug W388 from X368 of FSIM1, and plug to X368 of FSIM2.
 - Unplug W391 from X371 of FSIM1, and plug to X371 of FSIM2.

1.3.11 Option SMIQ-B19 - Rear Panel Connections for RF and LF

The SMIQ can be retrofitted to include rear panel connections for RF and LF for mounting it into a 19" rack using option SME-B19. The mounting instructions are attached to the option.

1.4 Mounting into a 19" Rack

Caution: *Ensure free air inlet at the perforation of the side walls and air outlet at the rear of the instrument in rack mounting.*

The SMIQ can be mounted into a 19" rack by means of rack adapter ZZA-94 (stock no. 396.4905.00). The mounting instructions are attached to the adapter .

2 Operation

2.1 Explanation of Front and Rear Panel

2.1.1 Elements of the Front Panel

2.1.1.1 Display

(cf. Fig. 2-1, A Front panel view, display)

1

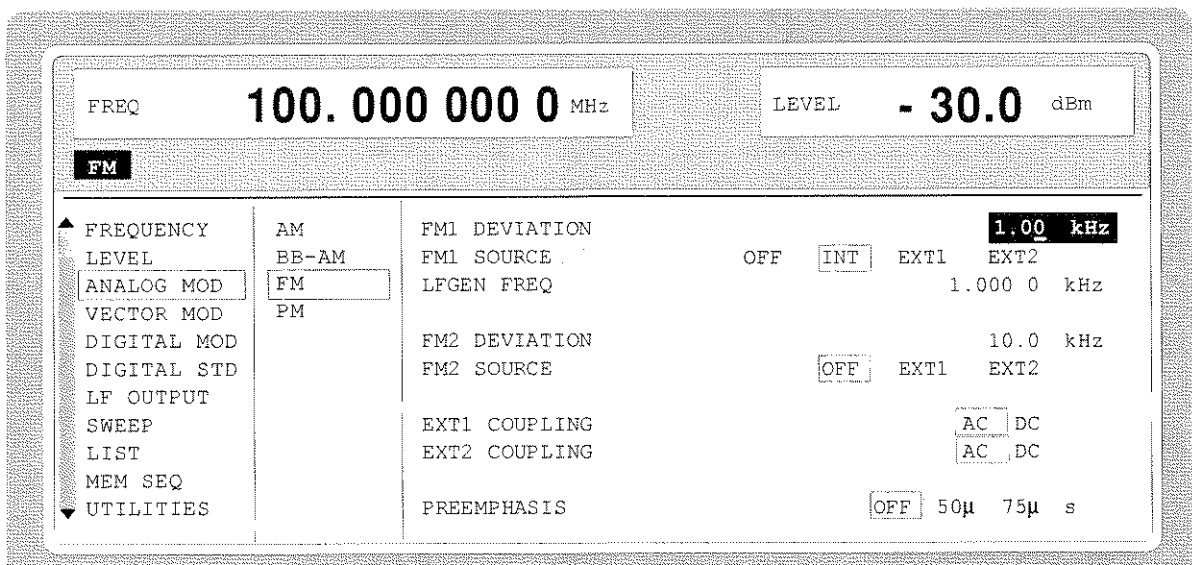

The display shows in the

header field: - the current frequency and level settings.
- status messages.
- error messages.

menu field: - the main menu and the submenus selected with the current settings.

Parameters can be selected and changed in the menus indicated.

see as well
Chapter 2
Section "Display"

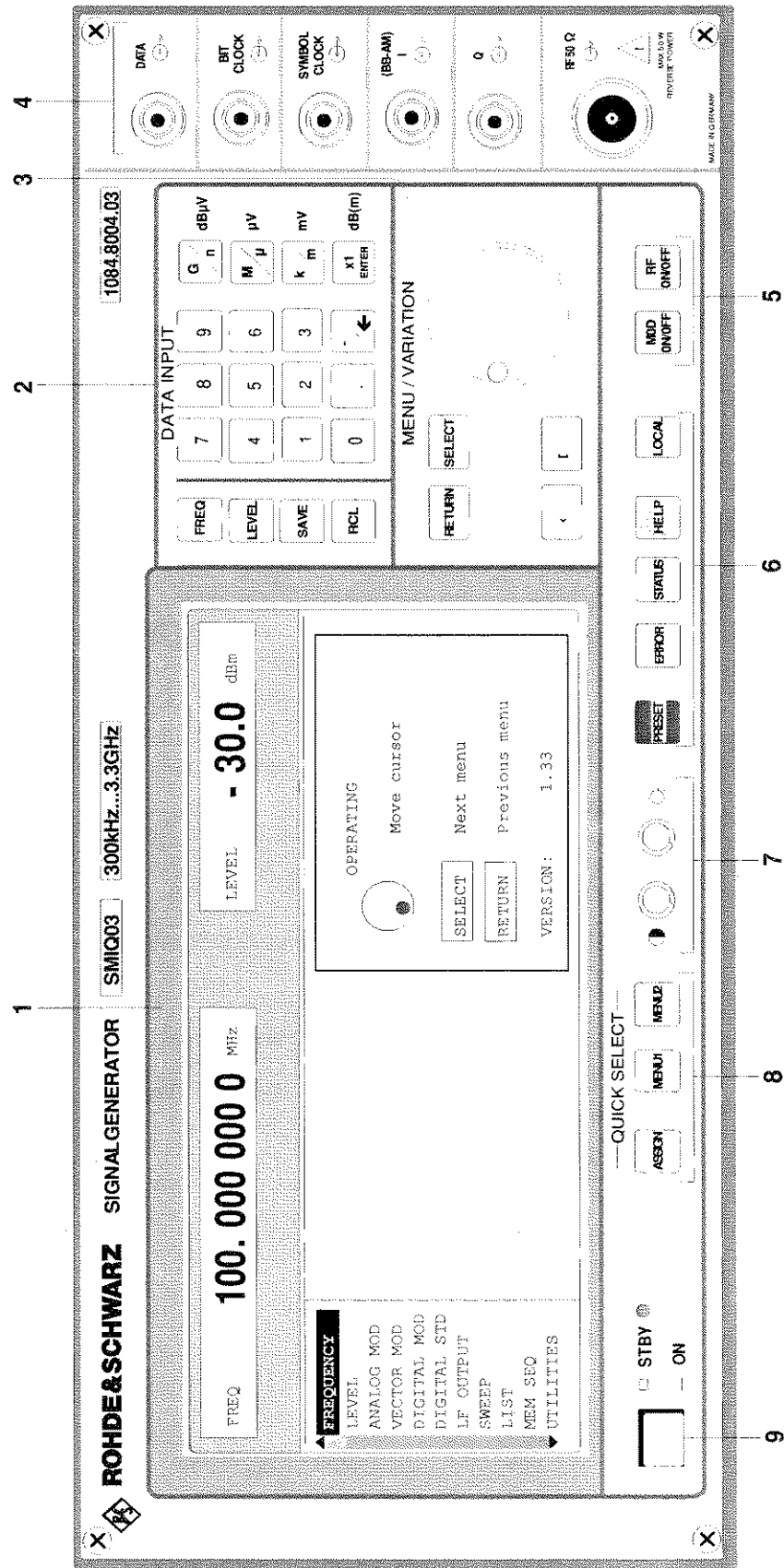

Fig. 2-1,a Front panel view, display

2.1.1.2 Controls

(cf. Fig. 2-1, A and B front panel view, controls)

2 DATA INPUT

Parameter field



Parameters RF frequency and RF level can be entered directly by means of the parameter keys, alternatively to menu operation. Further, complete instrument settings can be stored and called.

- FREQ** Opens the setting of the RF frequency via value input or variation by means of a rotary knob. The current menu is maintained. Return to the menu by means of the [RETURN] key. (Setting of the RF frequency also in the FREQUENCY menu).
- LEVEL** Opens the setting of the RF level via value input or variation by means of a rotary knob. The current menu is maintained. Return to the menu by means of the [RETURN] key. (Setting of the RF level also in the LEVEL menu).
- SAVE** Opens the storing of the current instrument setting. Memory selection is effected by entering a number (1 to 50) and is finished by means of the [ENTER] key.
- RCL** Opens the calling of an instrument setting stored. Memory selection is effected by entering a number (1 to 50) and is finished by means of the [ENTER] key.

see as well
Chapter 2
Section
"Use of [FREQ] and
[LEVEL] Keys"

Section
"RF Frequency"

Section
"RF Level"

Section
"Storing and Calling of
Instrument Settings"

Numeric input field

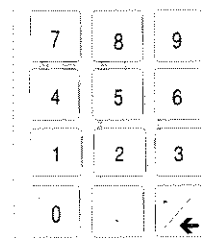

Numeric values, decimal point and minus sign can be entered by means of the digital keys.,

- 0...9 Enters the digit.
- Enters the decimal point
- /← Enters the minus sign.
Deletes the last input (digit, sign or decimal point) - key [BACKSPACE].

see as well
Chapter 2
Section
"Basic Operating
Steps"

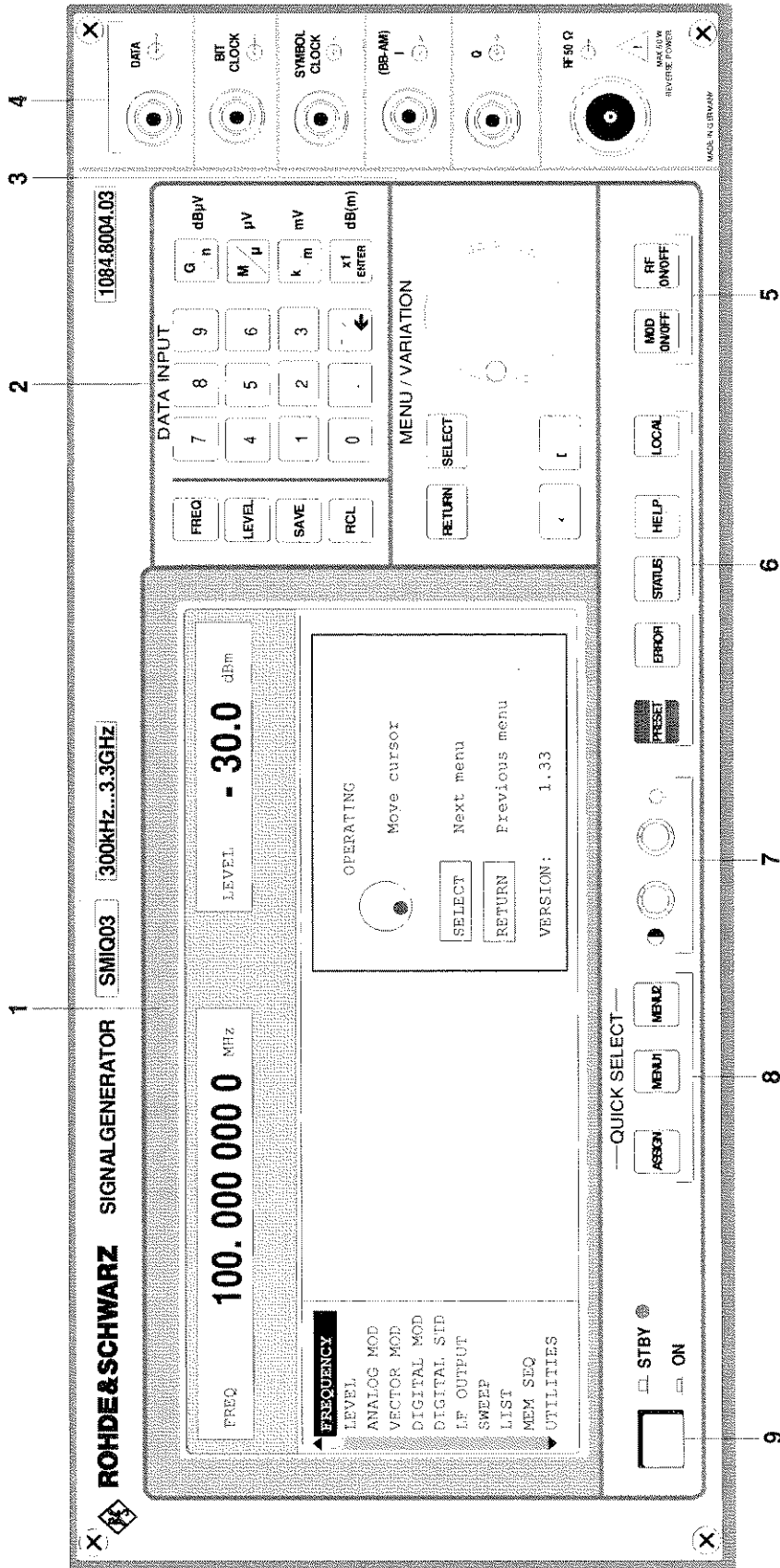
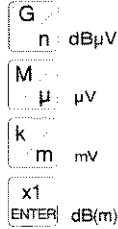

Fig. 2-1,b Front panel view, controls

2 DATA INPUT

Unit keys with enter function



The unit keys terminate the input of values and specify the multiplication factor for the respective basic unit. The basic units are displayed next to the input field while numbers are entered. In the case of level settings, the unit keys specify the unit.

G/n	dBμV	Selects giga/nano, with RF level dBμV, with LF level dBu.
M/μ	μV	Selects mega/micro, with level μV.
k/m	mV	Selects kilo/milli, with level mV.
1x		
Enter	dB(m)	Terminates entries in the basic unit and value inputs without unit. Selects with level dBm Selects with level offset and level step width dB.

see as well Chapter 2 Section "Basic Operating Steps" Section "Change Unit of Level"

In order to change to another level unit, simply press the unit key desired. Parameter LEVEL must be activated, e.g. by pressing the [LEVEL] key.

3 MENU/VARIATION

Menu keys

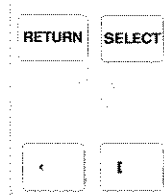

The menu keys access the menus and settings within the menus.

RETURN	Returns the menu cursor to the next higher menu level.
SELECT	Acknowledges the choice marked by the menu cursor
←	Moves the digit cursor to the left by one position in the marked value indication. Moves the menu cursor to the left by one position in a 1-out-of-n selection.
⇒	Moves the digit cursor to the right by one position in the marked value indication. Moves the menu cursor to the right by one position in a 1-out-of-n selection.

see as well Chapter 2 Section "Basic Operating Steps"

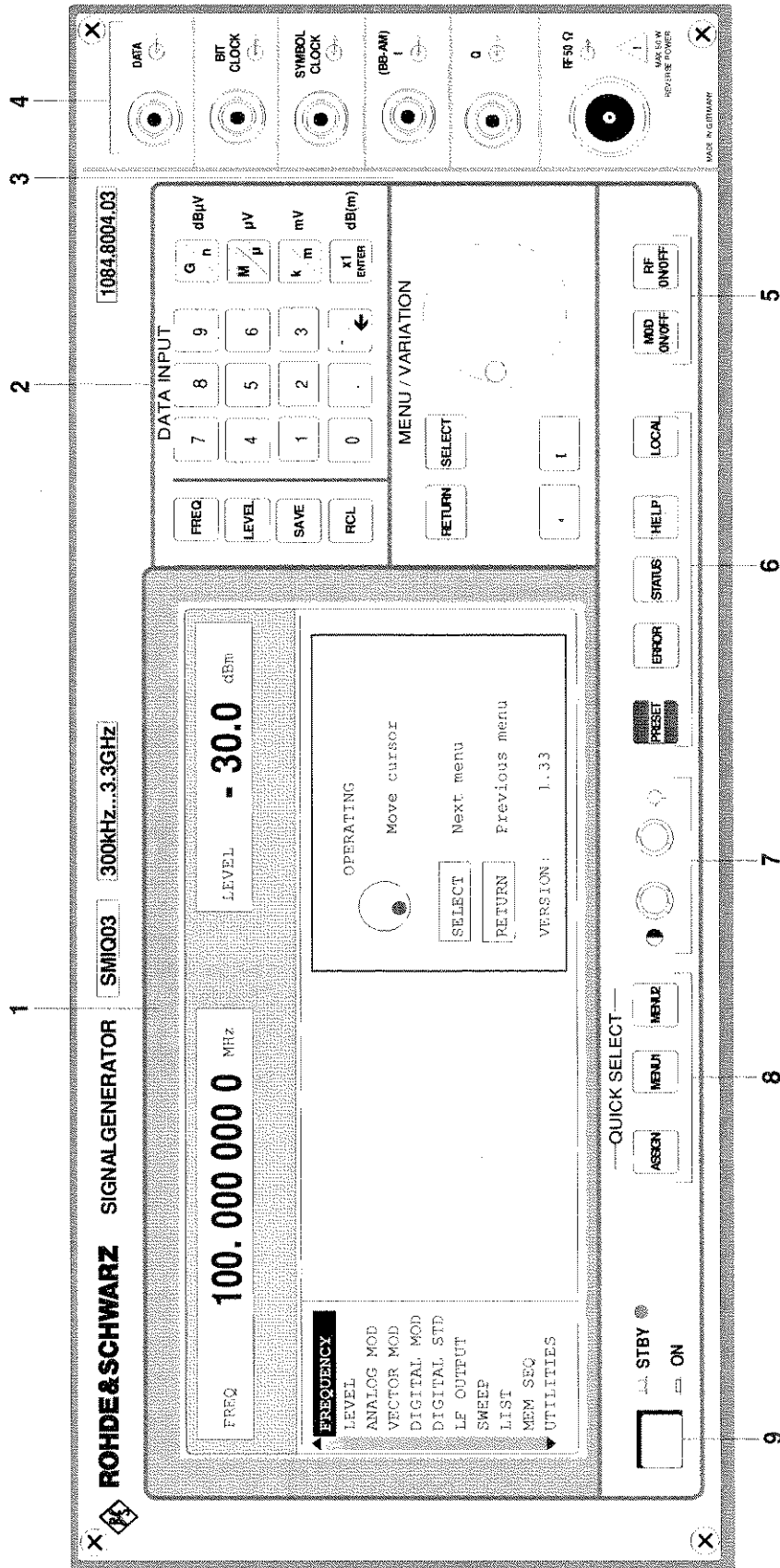

Fig. 2-1,b Front panel view, controls

3 MENU/VARIATION

Rotary knob



The rotary knob moves the menu cursor over the positions of a menu level to choose from or varies the value of a parameter. The variation is either effected in steps of one or in a step width that can be specified at will.

See as well
Chapter 2
Section "Basic Operating Steps"
Section "Sample Setting for First Users"

4

See next Section "Inputs/Outputs".

5



RF
ON/OFF

MOD
ON/OFF

Switches on/off the RF signal.

Switches on/off the modulation selected in the UTILITIES MOD KEY menu.

See as well
Chapter 2
Section "Use of [RF ON/OFF] and [MOD ON/OFF] Keys"

6



PRESET Establishes a defined instrument status.

ERROR* Indicates error and caution messages.

STATUS* Indicates the instrument status.

HELP* Indicates context-sensitive auxiliary text.

LOCAL Switches the instrument from the REMOTE mode (remote control) to the LOCAL mode (manual control).

See as well
Chapter 1
Section "Preset Setting"

Chapter 2
Section "Help System"

Section "Status"

Section "Error Messages"

Chapter 3,
Remote Control

* Exit the menus using the [RETURN] key.

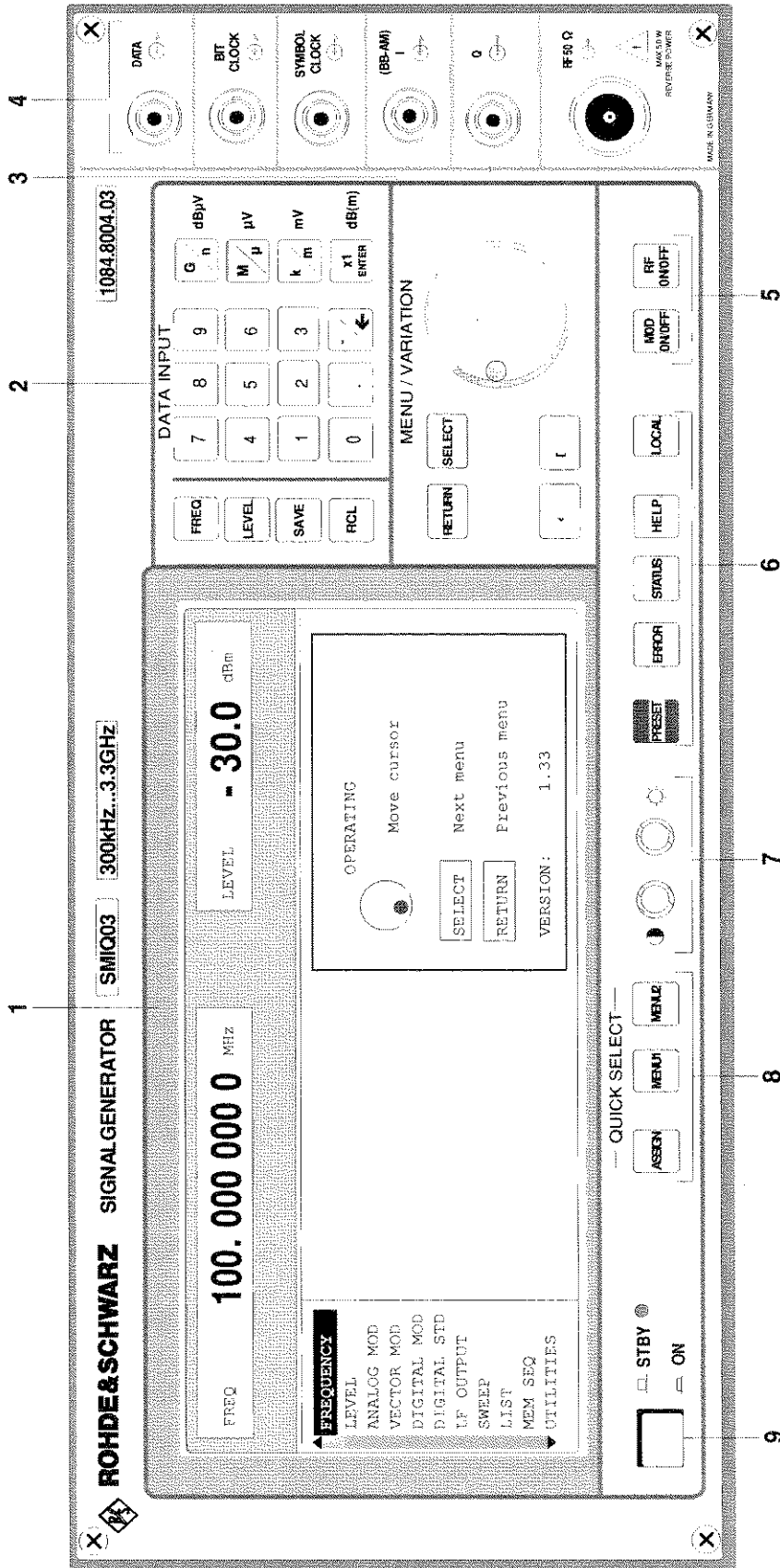

Fig. 2-1,b Front panel view, controls

7



Brightness and contrast of the display can be set using the rotary knobs.

-  Contrast
-  Brightness

See as well
Chapter 1
Section "Setting of Contrast and Brightness of the Display"

8 QUICK SELECT

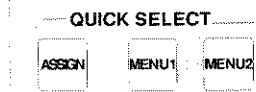

The menu-quick-selection keys permit fast access to two menus selected.

- ASSIGN** Stores the current menu as menu1 when the MENU1 key is pressed afterwards or as menu2 when the MENU2 key is pressed afterwards.
- MENU1** Activates menu1 stored.
- MENU2** Activates menu2 stored.

See as well
Chapter 2
Section "Basic Operating Steps"

9 Switching On/Off

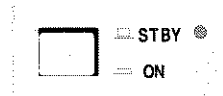

The On/Off switch switches the instrument from the standby mode to the ready-for-operation status. Prerequisite: The power switch at the rear of the instrument must be switched on.

- STBY** LED is illuminated in the standby mode.

see as well
Chapter 2
Section "Switching On/Off the Instrument"
Section "Elements of the Rear Panel, Power Switch"

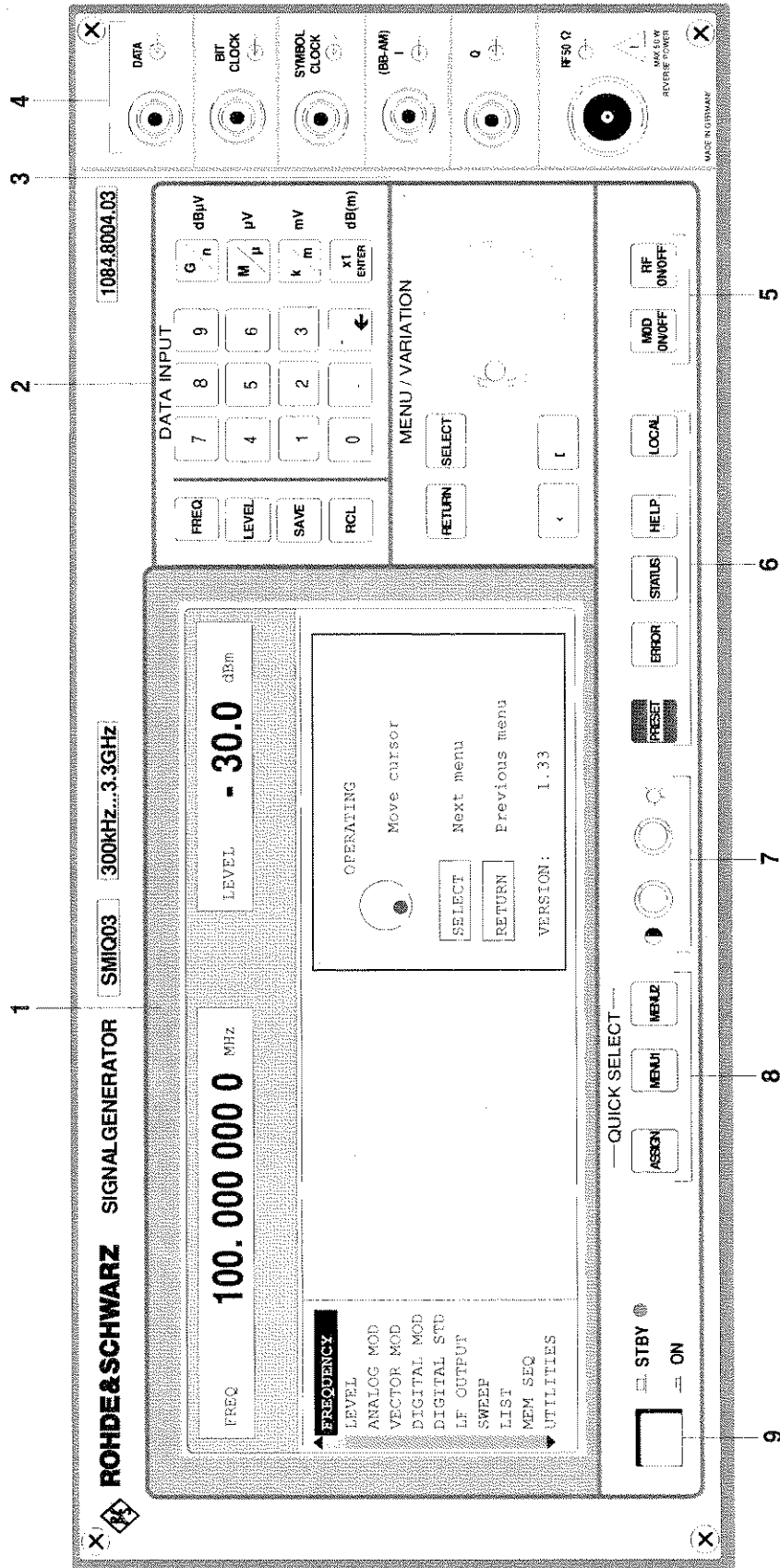













Fig. 2-1,c Front panel view, inputs/outputs

2.1.1.3 Inputs/Outputs

(Cf. Fig. 2-1, C Front panel view, Inputs/Outputs)

4

 <p>DATA</p>	<p>DATA</p>	<p>Input external data signal for digital modulation. Input resistance 1 kΩ or 50 Ω, Trigger threshold can be set from -2.5 to + 2.5V, max. ± 15 V, max. 40 mA.</p>	<p>See as well Chapter 2, Section "Digital Modulation"</p>
 <p>BIT CLOCK</p>	<p>BIT CLOCK</p>	<p>Output* data signal with operating mode internal. Level: TTL</p>	<p>Section "Digital Modulation"</p>
 <p>SYMBOL CLOCK</p>	<p>SYMBOL CLOCK</p>	<p>Input* external clock-pulse signal for synchronization of external data signal.</p>	<p>Section "Digital Modulation"</p>
 <p>(BB-AM)</p>	<p>(BB-AM)</p>	<p>Input resistance 1 kΩ or 50 Ω, Trigger threshold can be set from -2.5 to + 2.5V, max. ± 15 V, max. 40 mA.</p>	<p>Section "Vector Modulation" and Section "Broadband AM"</p>
 <p>Q</p>	<p>Q</p>	<p>Output* clock-pulse signal with operating mode internal. Level: TTL</p>	<p>Section "Digital Modulation"</p>
 <p>RF 50 Ω</p>	<p>SYMBOL CLOCK</p>	<p>Input* external clock signal for synchronization of the external data signal with polyvalent modulation types with several bits per symbol. Input resistance 1 kΩ or 50 Ω, Trigger threshold can be set from -2.5 to + 2.5V, max. ± 15 V, max. 40 mA. Output* symbol clock signal with operating mode internal. Level TTL</p>	<p>Section "Use of [ON/OFF] and [MOD ON/OFF] Key"</p>
 <p>(BB-AM) I</p>	<p>(BB-AM)</p>	<p>Input external modulation signal for I/Q modulation and broadband-AM. Output* I-signal with operating mode internal.</p>	<p>Section "Vector Modulation" and Section "Broadband AM"</p>
 <p>Q</p>	<p>Q</p>	<p>Input/output resistance 50 Ω. Nominal voltage (I/Q): $U_S = 0.5 V$ Nominal voltage (BB-AM): $U_S=0.25V$ max. permissible overvoltage: ± 5V</p>	<p>Section "Vector Modulation" and Section "Broadband AM"</p>
 <p>Q</p>	<p>Q</p>	<p>Input external modulation signal for I/Q modulation. Output* Q-signal with operating mode internal.</p>	<p>Section "Vector Modulation" and Section "Broadband AM"</p>
 <p>Q</p>	<p>Q</p>	<p>Input/output resistance 50 Ω. Nominal voltage: $U_S = 0.5 V$ max. permissible overvoltage: ± 5V</p>	<p>Section "Vector Modulation" and Section "Broadband AM"</p>
 <p>RF</p>	<p>RF</p>	<p>Output RF signal. Source resistance 50 Ω max. permissible HF-power: 50 W max. permissible overvoltage: 35 V</p>	<p>Section "Use of [ON/OFF] and [MOD ON/OFF] Key"</p>

* When fitted with option Modulation coder, SMIQ-B10

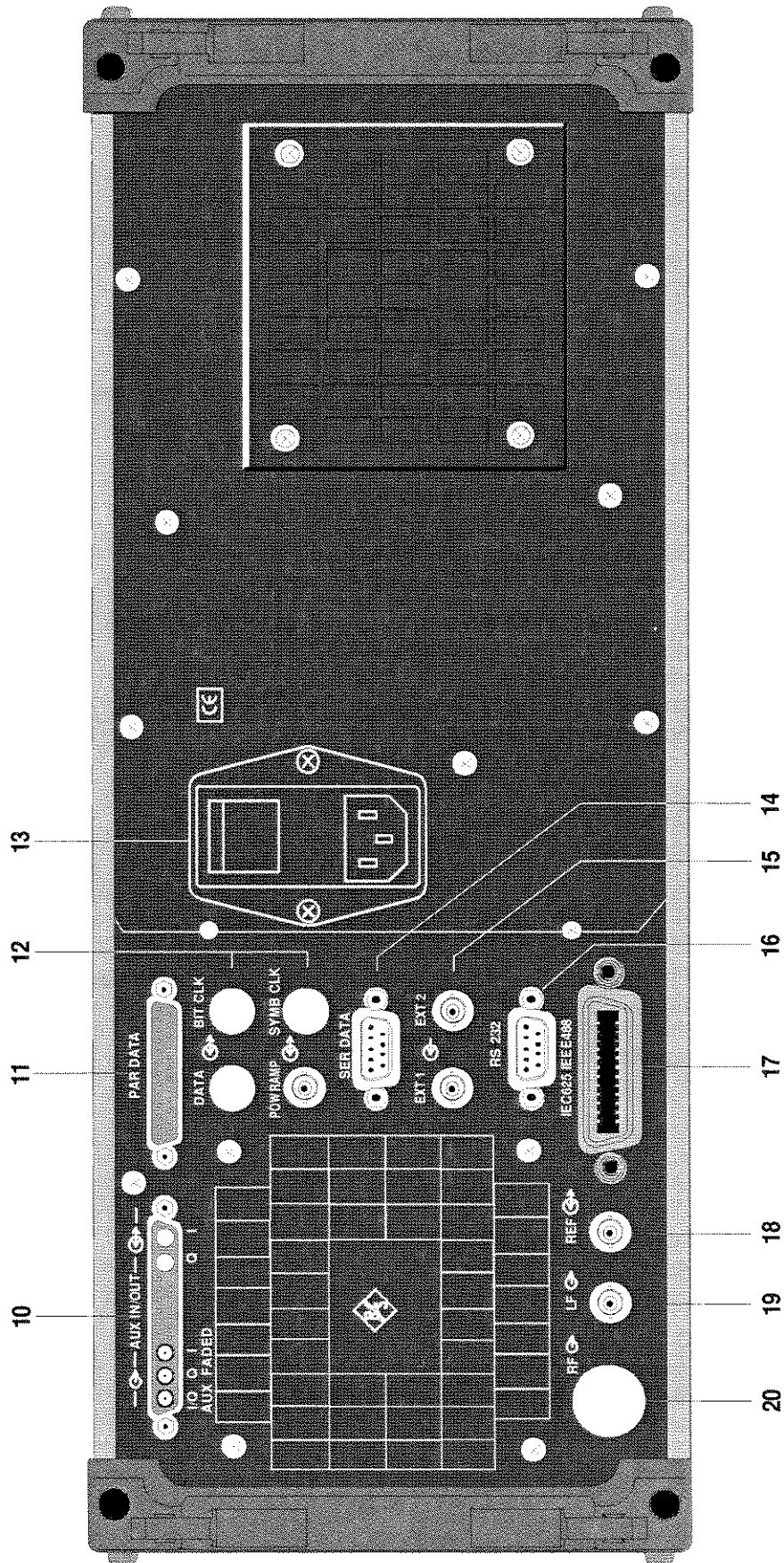
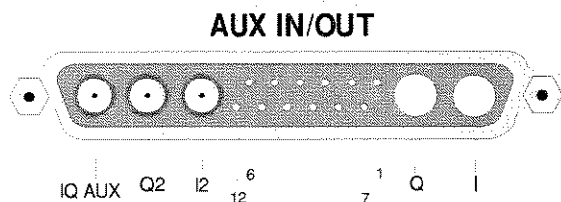

Fig. 2-2 Rear panel view

2.1.2 Elements of the Rear Panel

(Cf. Fig. 2-2, Rear panel view)

10



AUX IN/OUT

Pin	Description
IQ AUX	Output I/Q modulated subcarrier. Frequency 300 MHz, level -5 dBm, source resistance 50Ω
Q2	Output Q-signal of the second fading simulator for controlling of a second SMIQ with 2-channel fading.
I2	Output I-signal of the second fading simulator for controlling of a second SMIQ with 2-channel fading.
Q	Cut-out, provided to relocate the Q- input at the front to the rear of the instrument.
I	Cut-out, provided to relocate the I- input at the front to the rear of the instrument.
1 - TRIGGER	Input to trigger sweep, LIST mode and Memory Sequence. Level: TTL
2 - PULS	Input for pulse modulation. Level: TTL Input resistance 10Ω
3 - ⊥	Ground
4 - BLANK	Output supplies a signal to blank the return sweep or the settling process in LIST mode Level: TTL
5 - MARKER	Output is active when the sweep reaches the marker or at the first step of the LIST mode. Level: TTL
6 - X_AXIS	Output supplies a voltage ramp of 0 to 10 V, when a sweep is switched on.
7 - ⊥	Ground
8 - EXT TUNE	Tuning input for the internal reference frequency. Voltage range ± 10 V, pulling range ±1·10 ⁻⁶
9 - ⊥	Ground

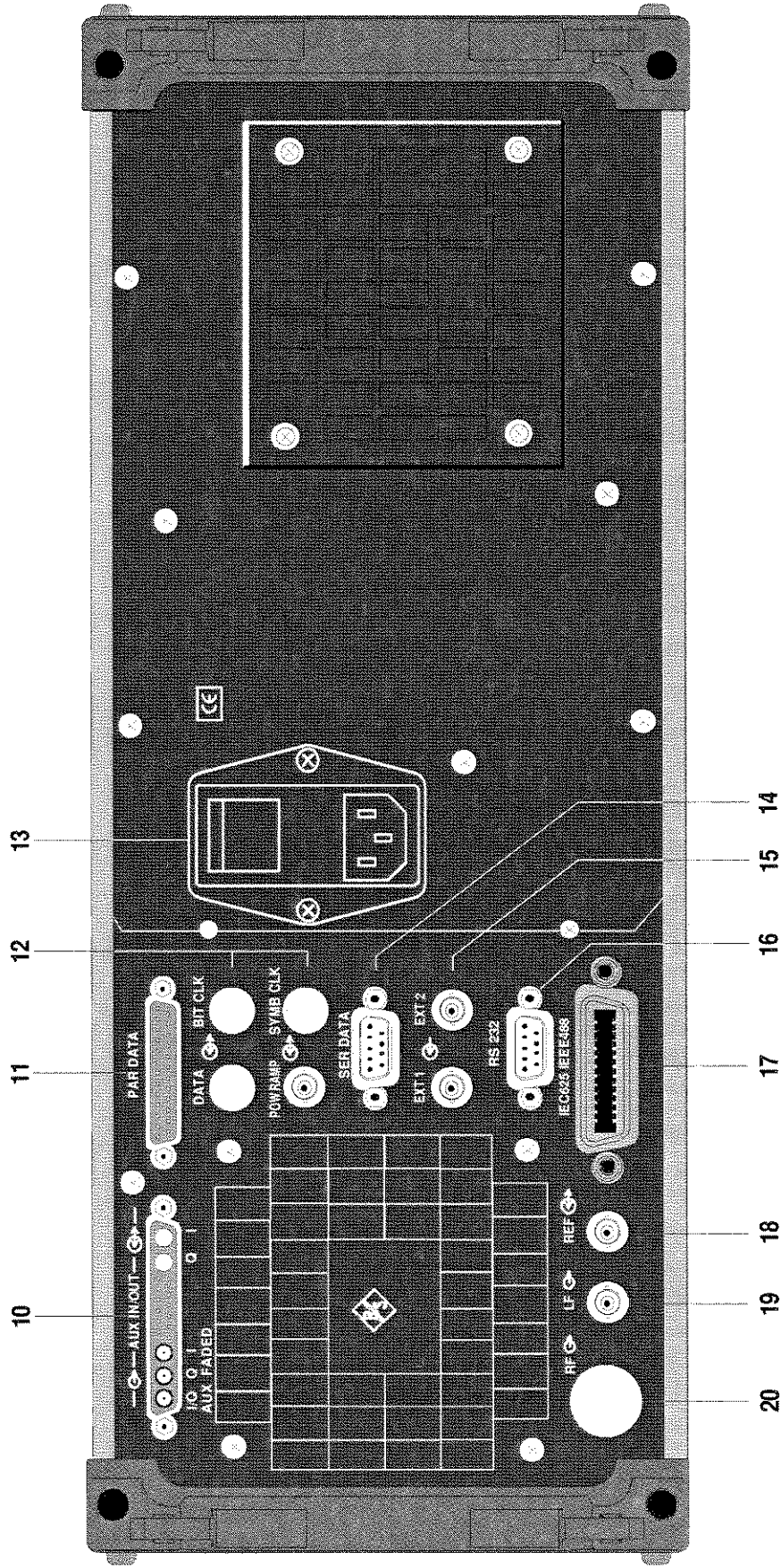
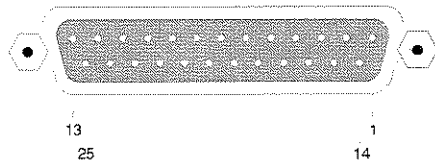

Fig. 2-2 Rear panel view

11

PAR DATA



An adapter between the PAR DATA connector and coaxial BNC connectors is available as an accessory (SMIQ-Z5, order no. 1104.8555.02).

PAR DATA

Pin	Description
1 - ⊥	Ground
2 - ⊥	Ground
3 - DATA-D6	Parallel data input/output D0 to D6 for digital modulation. Output: TTL signal. Input: Input resistance 1kΩ or 50Ω. Trigger threshold can be set from -2,5 to 2,5V, max. ± 15V, max. 40 mA
4 - DATA-D4	
5 - DATA-D2	
6 - DATA-D0	
7 - SYMBCLK	Symbol clock input/output for synchronization of the data signal with modulation types with several bits per symbol. Output: TTL signal. Input: Input resistance 1kΩ or 50Ω. Trigger threshold can be set from -2,5 to 2,5V, max. ± 15V, max. 40 mA
8 - ⊥	Ground
9 - LEV-ATT	Signal input/output for controlling of level reduction. Output: TTL signal. Input: Input resistance 1kΩ or 50Ω. Trigger threshold can be set from -2,5 to 2,5V, max. ± 15V, max. 40 mA
10 - ⊥	Ground
11 - TRIGOUT 1	Output for triggering of external instruments. Output: TTL signal.
12 - ⊥	Ground
13 - ⊥	Ground
14 - TRIGIN	Input for triggering of frames, PRBS and data sequences. Input: Input resistance 1kΩ or 50Ω. Trigger threshold can be set from -2,5 to 2,5V, max. ± 15V, max. 40 mA
15 - DATA-D7	Parallel data input/output D1 to D7 see pin 3 - 6
16 - DATA-D5	
17 - DATA-D3	
18 - DATA-D1	
19 - ⊥	Ground

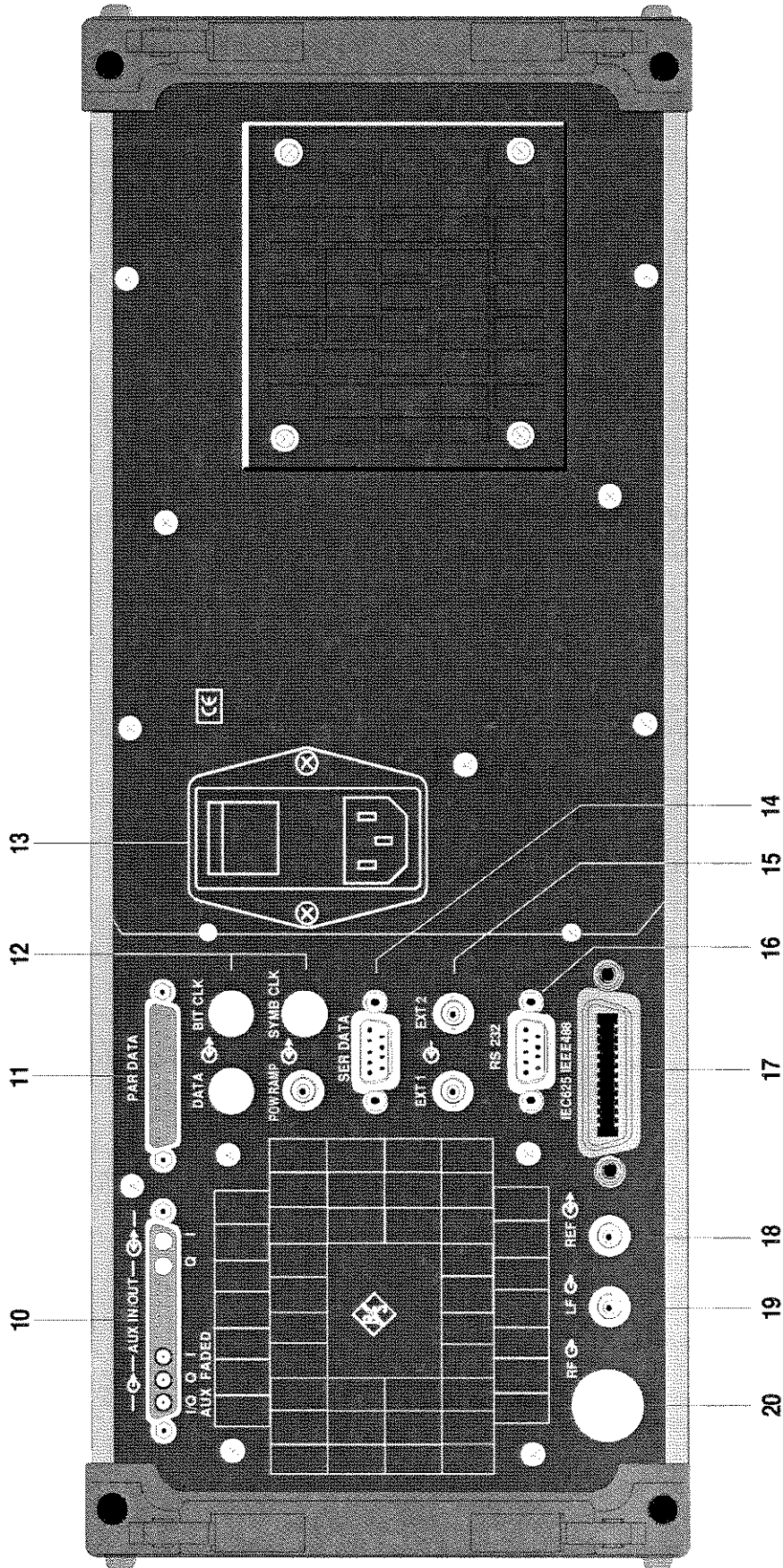

Fig. 2-2 Rear panel view

11

PAR DATA

pin	Description
20 - BITCLK	Output bit clock with operating mode internal. TTL signal
21 - CW	Signal input/output for controlling of modulation. Switches carrier to CW with FSK modulation. Output: TTL signal. Input: input resistance 1kΩ or 50Ω. Trigger threshold can be set from -2,5 to 2,5V, max. ± 15V, max. 40 mA
22 - BURST-GATE	Signal input/output for controlling of the burst profile. Output: TTL signal. Input: input resistance 1kΩ or 50Ω. Trigger threshold can be set from -2,5 to 2,5V, max. ± 15V, max. 40 mA
23 - TRIGOUT 2	Output for triggering and controlling of external instruments. Output: TTL signal.
24 - TRIGOUT 3	Output for triggering and controlling of external instruments. Output: TTL signal.
25 - HOP	HOP output provides control signal when internal frequency hopping is programmed. Output: TTL signal

12



DATA Cut-out, provided to relocate the DATA input/output at the front to the rear of the instrument.



BIT CLK Cut-out, provided to relocate the BIT CLK input/output at the front to the rear of the instrument.

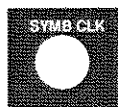

SYMB CLK Cut-out, provided to relocate the SYMB CLK input/output at the front to the rear of the instrument.



POW RAMP Signal input/output for power ramping.
Input: accepts analog voltages from 0 to 1 V for envelope modulation.
Input resistance 10kΩ
Max. permissible overvoltage ±15 V
Output provides modulation voltage of burst envelope with internal modulation.
output resistance 10Ω
Max. permissible overvoltage ±15 V

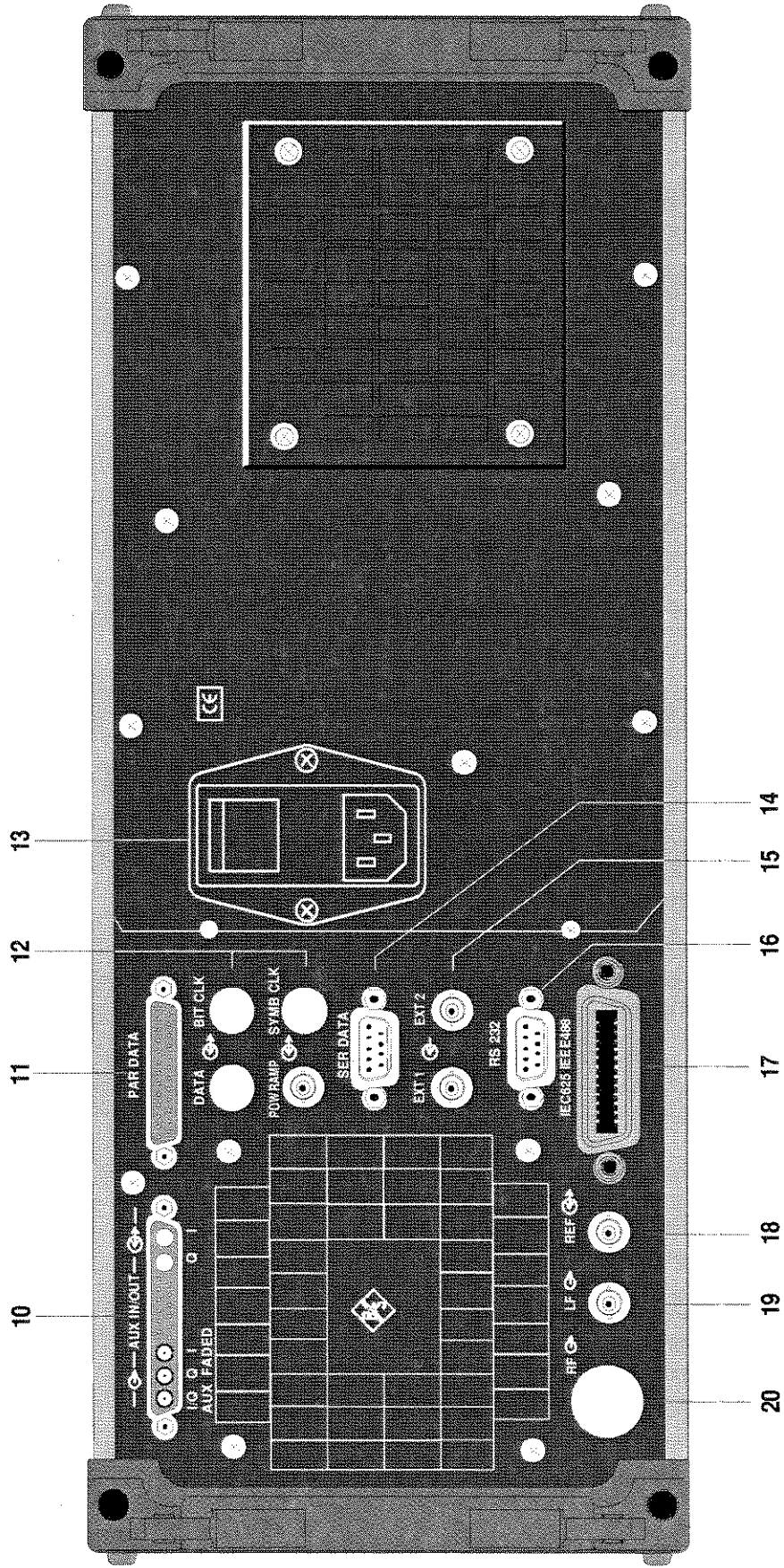
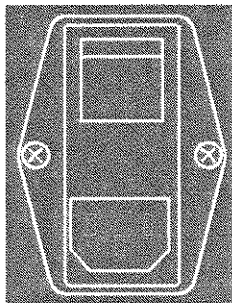

Fig. 2-2 Rear panel view

13



Power switch
ON when pressed at the top (I)

Power supply connection

see as well
Chapter 1,
Section
"Supply Voltage"
Section
"Switching On/off the
Instrument"

14



SER DATA Asynchronous data input for digital modulation.
Interface: RS232 up to 115 kbps

see as well
Annex A
"interfaces"

15

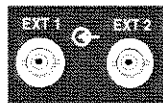

EXT1 Input external modulation signal, alternatively for AM or FM (PM).
Input resistance >100 kΩ.
Nominal voltage: $U_S = 1\text{ V}$
Max. permissible overvoltage: $\pm 15\text{ V}$

EXT2 Input external modulation signal for FM (PM).
Input resistance >100 kΩ.
Nominal voltage: $U_S = 1\text{ V}$
Max. permissible overvoltage: $\pm 15\text{ V}$

16

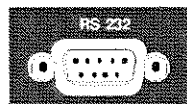

RS-232 RS-232 interface, used for software update, the loading of calibration data, and remote control. The pin assignment corresponds to the pin assignment of a PC.

see as well
Chapter 3
Remote Control
and
Annex A
"Interfaces"

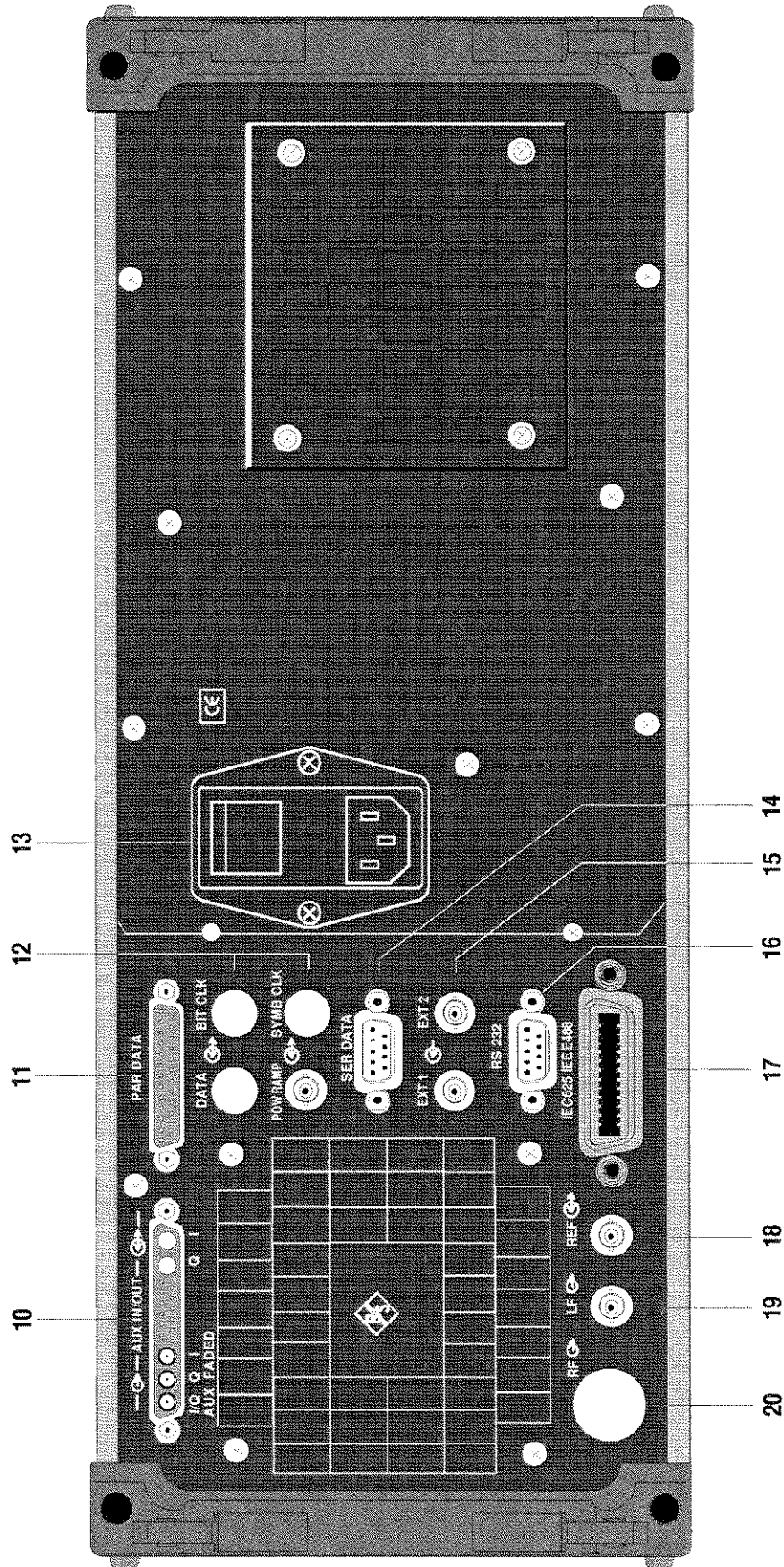
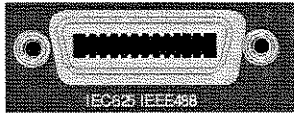

Fig. 2-2 Rear panel view

17 IEC 625 IEC-Bus (IEEE 488) Remote-control interface



IEC 625 IEC-Bus (IEEE 488)
 IEEE 488 Remote-control interface

See as well
 Chapter 3,
 Remote Control

18 REF Output of the internal 10-MHz reference signal with reference internal. Source resistance 50 Ω. Input for external reference frequency with reference external. Adjustable to external reference frequencies from 1 to 16 MHz in 1-MHz steps. Input resistance 200 Ω.



REF Output of the internal 10-MHz reference signal with reference internal. Source resistance 50 Ω. Input for external reference frequency with reference external. Adjustable to external reference frequencies from 1 to 16 MHz in 1-MHz steps. Input resistance 200 Ω.

See as well
 Chapter 2,
 Section
 "Reference Frequency
 int/ext"

19 LF Output LF signal of the internal LF generator. Source resistance < 10 Ω.

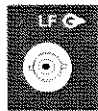

LF Output LF signal of the internal LF generator. Source resistance < 10 Ω.

20 RF Cut-out, provided to relocate the RF output at the front to the rear of the instrument

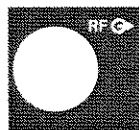

RF Cut-out, provided to relocate the RF output at the front to the rear of the instrument

2.2 Operating Concept

2.2.1 Display

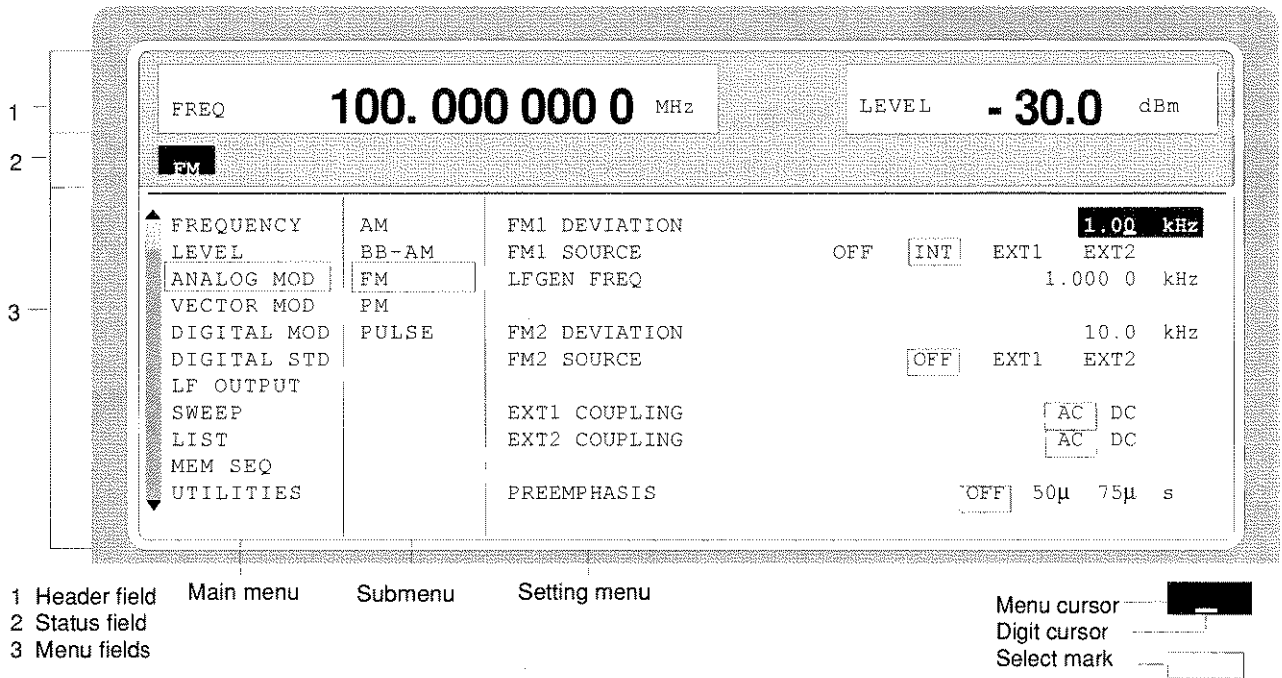

Fig. 2-3 Design of the display

Header field (1) The header field of the display indicates frequency and level of the RF output signal. In the RF-sweep operating mode, the start and stop frequencies are displayed in two lines one above the other. The start and stop levels are indicated in the LEVEL-sweep operating mode correspondingly. A two-line level display appears for digital modulation or digital standard. The upper line indicates the average power (LEVEL), the lower line the peak envelope power (PEP) of the modulated RF output signal.

Status line (2) The status line below describes operating mode and operating state of the instrument. Error messages and notes for caution are also displayed in the status line.

Menu fields (3) The indication fields below the header field are reserved for the menu representations. The image contents of these fields change as a function of the menu selected. The field at the left-hand display margin is occupied with the main menu, the topmost level of the menu structure. The main menu is always faded in.

Each further field adjacent at the right contains submenus.

The field ending with the right-hand display margin shows the setting menu. In this menu all setting values and setting states connected with the menu selected are indicated. When accessing submenus, the higher-order menus remain in the display. The current menu path is evident through the select marks.

Menu cursor The menu cursor shows the user at which position in the menu he is. The position of the menu cursor is evident from the inverse notation of the term (white characters on a black background)

Digit cursor As an underscore, the digit cursor marks the position which can be varied by means of the rotary knob in a value indication.

Select mark The frame around a term marks current menus or valid settings in the setting menu.

2.2.2 Basic Operating Steps

The operating principle is explained in this section. For better understanding, please read sections "Display" (Section 2.2.1) and "Sample Setting for First Users" (Section 2.2.3) in addition.

To operate the instrument, menus are called in the display. All setting possibilities and the current setting status are evident from the menus. All settings can be made by accessing the menus.

RF frequency and RF level can also be set without menu operation using keys [FREQ] and [LEVEL]. RF signal and modulation can also be switched on/off without menu operation using keys [RF ON/OFF] and/or [MOD ON/OFF].

2.2.2.1 Calling the Menus

Accessing the menus is effected using rotary knob [VARIATION], [SELECT] key and [RETURN] key.

Rotary knob Rotary knob [VARIATION] moves the menu cursor over the positions of a menu level to be selected.

If a scrollbar is visible at the left-hand margin of a menu, the menu is larger than the screen window. If the menu cursor is moved to the margin of the screen window, the covered lines become visible.

[SELECT] key The [SELECT] acknowledges the selection marked by means of the menu cursor.

[RETURN] key The [RETURN] key

- returns the menu cursor to the next higher menu level.
The menu cursor is shifted to the left into the preceding column of the menu structure.
- resets the menu cursor from frequency or level value indication in the header field into the menu field to the menu called last.
- closes the display pages called using keys [STATUS], [HELP] and [ERROR] again.

Settings are accessed in the setting menus ending with the right-hand display margin.

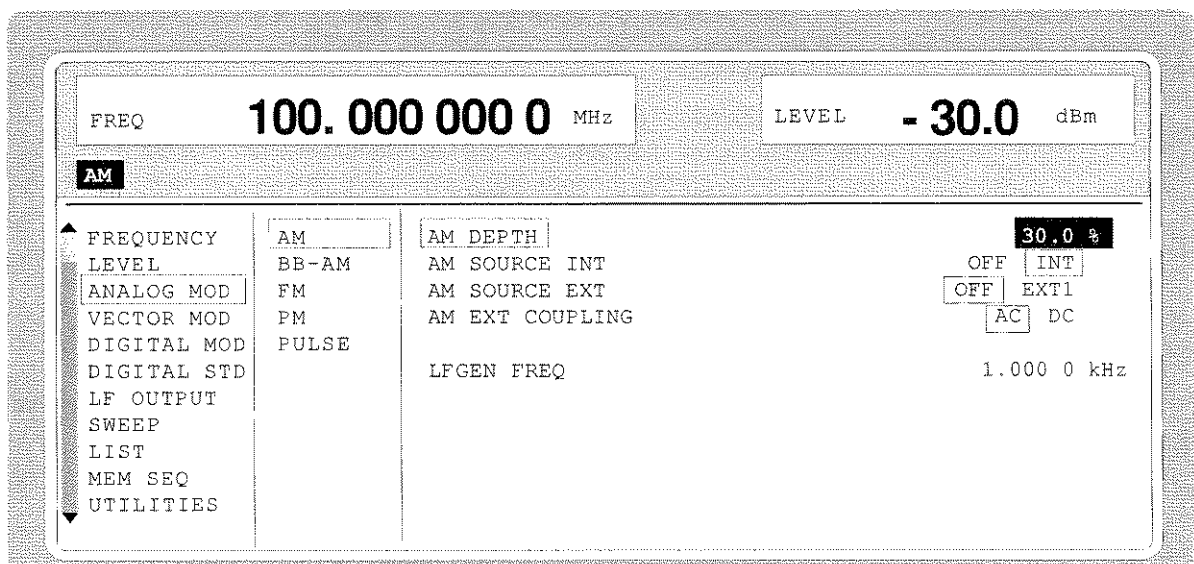

Fig. 2-4 MODULATION-AM menu

2.2.2.2 Selection and Change of Parameters

- Select parameter** ➤ Set the menu cursor to the name of the parameter desired using the rotary knob, e.g. to AM DEPTH in the AM menu, Fig. 2.4..
- Change setting value**
- Select parameters.
 - Press the [SELECT] key.
 - The menu cursor changes from the parameter selected in the left-hand column of the setting menu to the setting value on the right, e.g. from AM DEPTH to 30%, Fig. 2-4.
- via value inputs
- Press the first digit of the new value or minus sign.
The old value is deleted, the entry is indicated in the marked field.
 - Enter further digits.
 - Terminate the input using a unit key or, in the case of inputs in the base unit or in the case of inputs without unit, using the [1x/Enter] key.
 - Press the [RETURN] key.
The menu cursor wraps back to the appropriate parameter.
- using rotary knob
- Set the underscore to the position of the setting value to be varied using keys [⇒] [⇐].
 - Turn the rotary knob.
The position underscored is varied in steps of 1.
- Note:** *RF frequency and RF level can also be varied in a step width which can be defined arbitrarily using the rotary knob. In the respective setting menu (FREQUENCY or LEVEL) the step width is entered as KNOB STEP USER and the KNOB STEP set from DECIMAL to USER. To point to the fact that the step width has been converted to the value programmed, the underscore as a symbol of the digit cursor disappears in the respective value indication.*
- 1-out-of-n selection**
- Select parameters.
 - Press the [SELECT] key.
The menu cursor changes from the parameter selected in the left-hand column of the setting menu to the current selection on the right, e.g. from AM SOURCE EXT to OFF, Fig. 2-4.
 - Set the menu cursor to the position desired within the 1-out-of-n selection using the rotary knob or cursor keys [⇐] [⇒].
 - Press the [SELECT] key.
The setting is made.
The selection mark which has marked the setting valid up to now wraps to the new position.
 - Press the [RETURN] key.
The menu cursor wraps back to the respective parameter

Quick selection of a parameter

The quick selection of a parameter reduces the number of operating steps if several parameters are set successively. The menu cursor can directly be set further from line to line in the column of the setting values.

- Press the [SELECT] key.

The menu cursor wraps from the setting value of a parameter to the setting value of the parameter in the next line.

The following is true:

- The wrap from a 1-out-of-n selection line into the next line is effected when menu cursor and selection mark are superimposed.
- Actions which can be carried out are skipped.
- If necessary, scrolling is triggered at window limits.
- A wraparound is effected at the end of the menu.
- The column of the setting values can be exited at each position by pressing the [RETURN] key.

2.2.2.3 Triggering Action

Lines in the setting menu which are marked with the "▶" symbol at the end of the line qualify an action which can be carried out. Instruction SEARCH ONCE ▶ in the LEVEL-ALC menu, e.g., switches on level control for level calibration for a short period of time.

Trigger action

- Set the menu cursor to the respective instruction.
- Press the [SELECT] key.

The action is triggered.

While the action is carried out, the instruction remains framed by the selection mark.

2.2.2.4 Quick Selection of Menu (QUICK SELECT)

The keys of the QUICK SELECT control field are used to call selected menus quickly by one keystroke.

Store menus

- Establish the desired operating status of the current menu.
- Press the [ASSIGN] key.
- Press key [MENU1] or [MENU2].
The current menu is stored as menu1 or menu2. That is to say, 2 menus can be stored in total.

Call menus

- Press key [MENU1] or [MENU2].
Menu1 or menu2 stored is displayed. Exactly the operating status which was current at the point of time of storing is reconstructed.

2.2.2.5 Use of [FREQ] and [LEVEL] Keys

RF frequency and RF level can be set without menu operation as well using direct keys [FREQ] and [LEVEL].

- Key [FREQ]/ [LEVEL]**
- Press the [FREQ] or [LEVEL] key.
 - The frequency and/or the level indication in the header field of the display is marked.
 - The current menu at the display is maintained.
 - Alter the value via a value input or the rotary knob.
 - Press the [RETURN] key.
 - The menu cursor wraps to the position marked last in the menu.

2.2.2.6 Use of [RF ON / OFF] and [MOD ON / OFF] Keys

RF signal and modulation can be switched on/off without menu operation as well using direct keys [RF ON / OFF] and/or [MOD ON / OFF] (see Sections [RF ON/OFF] key and [MOD ON/OFF] key as well).

- Key [RF ON / OFF]**
- Press the [RF ON / OFF] key.
 - The RF output signal is switched on/off.
 - IEC-bus-short command: :OUTP OFF

- Key [MOD ON / OFF]**
- Press the [MOD ON / OFF] key.
 - The modulation is switched on/off.
- A IEC-bus command is not available. The modulations have to be switched on and off in the respective modulation sub menus

2.2.2.7 Changing Unit of Level

For the level, the unit of the value set can be changed without a new value input.

- Change level unit**
- Activate LEVEL parameter.
 - Press the [LEVEL] key or
 - set the menu cursor in the LEVEL menu to the setting value of the AMPLITUDE parameter.
 - Press the unit key with the desired level unit.
 - The level is indicated in the desired unit.

2.2.2.8 Correction of Input

Digital entries can be corrected by one of the unit/Enter keys before terminating the input.

Key [←] The backspace key deletes the value entered digit by digit. When the last digit is deleted, the previous value is displayed.

Key [RETURN] Pressing the [RETURN] key deletes the entire entry and results in the previous value being indicated again.

For a subsequent new input in the setting menu, the menu cursor is to be set to the setting value again using the [SELECT] key.

For a subsequent new input via the [FREQ] or [LEVEL] keys, the respective key has to be pressed again.



Key [FREQ]/ [LEVEL] In the case of a frequency or level input by means of the [FREQ] or [LEVEL] keys, pressing the [FREQ] and/or [LEVEL] key again deletes the entire input.

2.2.3 Sample Setting for First Users

First users most quickly become familiar with the operation of the instrument if they execute the pattern setting of this section.



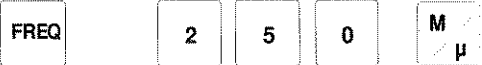





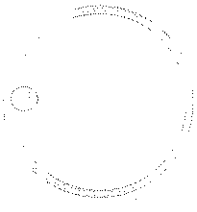

First frequency and level of the RF output signal are set via keys [FREQ] and [LEVEL] in the DATA INPUT field:

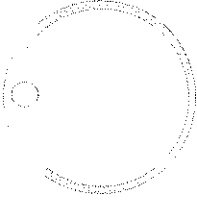

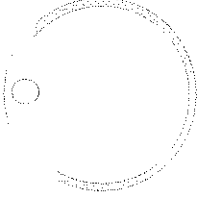

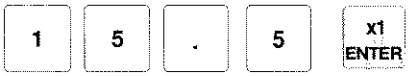
- Frequency 250 MHz
- Level 10 dBm

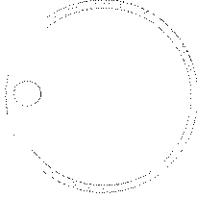
Operating steps	Explanations
	Reset the instrument to the defined state.
<p style="text-align: center;">DATA INPUT</p> 	Set the frequency to 250 MHz. The menu cursor marks the permanent frequency indication.
<p style="text-align: center;">DATA INPUT</p> 	Set the level to 10 dBm. The menu cursor marks the permanent level indication.
	Reset the menu cursor to the menu field.

The output signal is to be amplitude-modulated next.

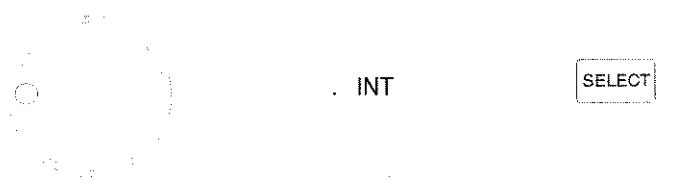
- AM modulation depth 15.5 %
- Modulation frequency 3 kHz

Operating steps		Explanations
<p>MENU / VARIATION</p>  <p>ANALOG MOD</p> <p>MENU / VARIATION</p> 	<p>Select ANALOG MOD menu.</p> <p>➤ Set menu cursor to ANALOG MOD using the rotary knob and subsequently press [SELECT] key.</p> <p>The submenu is displayed</p>	
<p>MENU / VARIATION</p>  <p>AM</p> <p>MENU / VARIATION</p> 	<p>Select AM submenu</p> <p>The AM setting menu is displayed.</p>	
<p>MENU / VARIATION</p>  <p>AM DEPTH</p> <p>MENU / VARIATION</p> 	<p>Select AM DEPTH parameter.</p> <p>The menu cursor marks the setting value.</p>	
<p>DATA INPUT</p> 	<p>Enter modulation depth 15.5 %.</p>	
<p>RETURN</p> 	<p>Reset menu cursor to AM DEPTH.</p>	
<p>MENU / VARIATION</p>  <p>AM SOURCE INT</p> <p>MENU / VARIATION</p> 	<p>Select AM SOURCE INT.</p> <p>The menu cursor marks the current 1-out-of-n selection.</p>	

Operating steps		Explanations
MENU / VARIATION	MENU / VARIATION 	Select INT 1 as internal modulation source. The selection mark marks INT. AM is faded in the status line as a hint that AM is switched on.
		Reset menu cursor to AM SOURCE INT.
MENU / VARIATION	MENU / VARIATION 	Select parameter LFGEN FREQ. The menu cursor marks the setting value.
DATA INPUT		Enter frequency 3 kHz. The selection mark marks the setting value. The indications on the display are represented in Fig. 2-5. The AM modulation setting is completed.

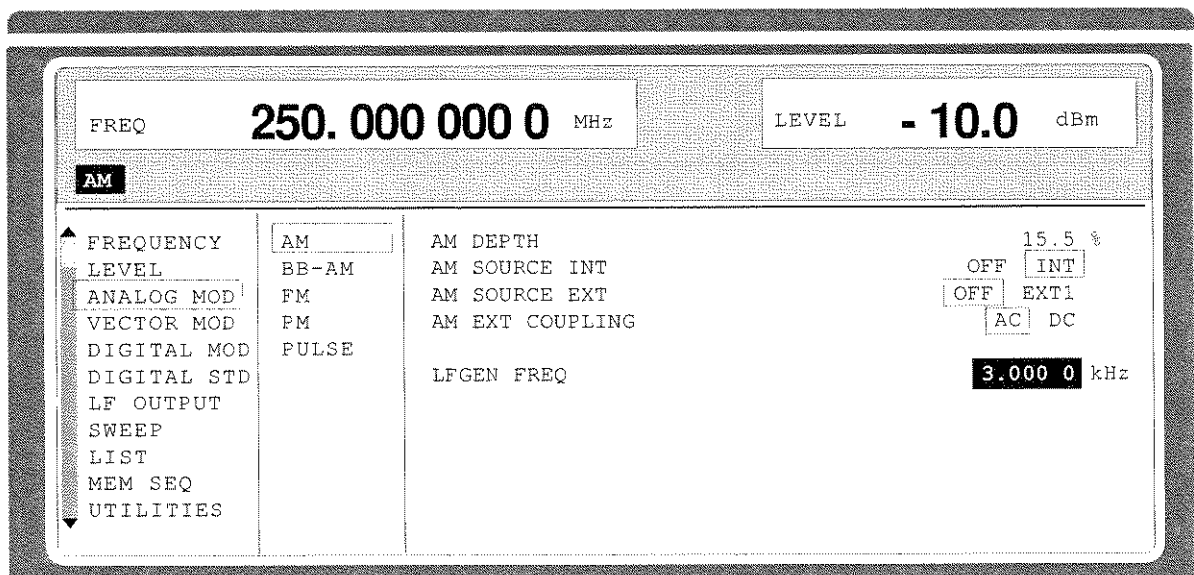

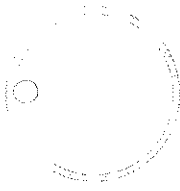

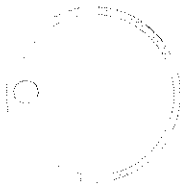







Fig. 2-5 Display after AM setting

Subsequently to the above setting, 420 MHz as new RF frequency and 12.5 kHz as the step width for the RF frequency variation are set in the following. Parameter quick select is used, which reduces the number of operating steps.

Operating steps	Explanations
	Reset the menu cursor to the main menu in 3 steps.
<p>MENU / VARIATION</p>  <p>FREQUENCY</p> <p>MENU / VARIATION</p> 	Select FREQUENCY menu. The frequency setting menu is displayed.
<p>MENU / VARIATION</p>  <p>FREQUENCY</p> <p>MENU / VARIATION</p> 	Select FREQUENCY parameter. The menu cursor marks the setting value.
<p>DATA INPUT</p> 	Enter frequency 420 MHz and acknowledge.
	Set menu cursor to the setting value of parameter KNOB STEP USER.
<p>DATA INPUT</p> 	Enter step width 12.5 kHz.
	Set menu cursor to the current KNOB STEP selection.

Operating steps		Explanations
<p>MENU / VARIATION</p>  <p>MENU / VARIATION</p>	<p>Select USER (user-defined step width).</p> <p>The selection mark marks USER.</p> <p>This results in step width 12.5 kHz being used in the case of variation using the rotary knob.</p>	

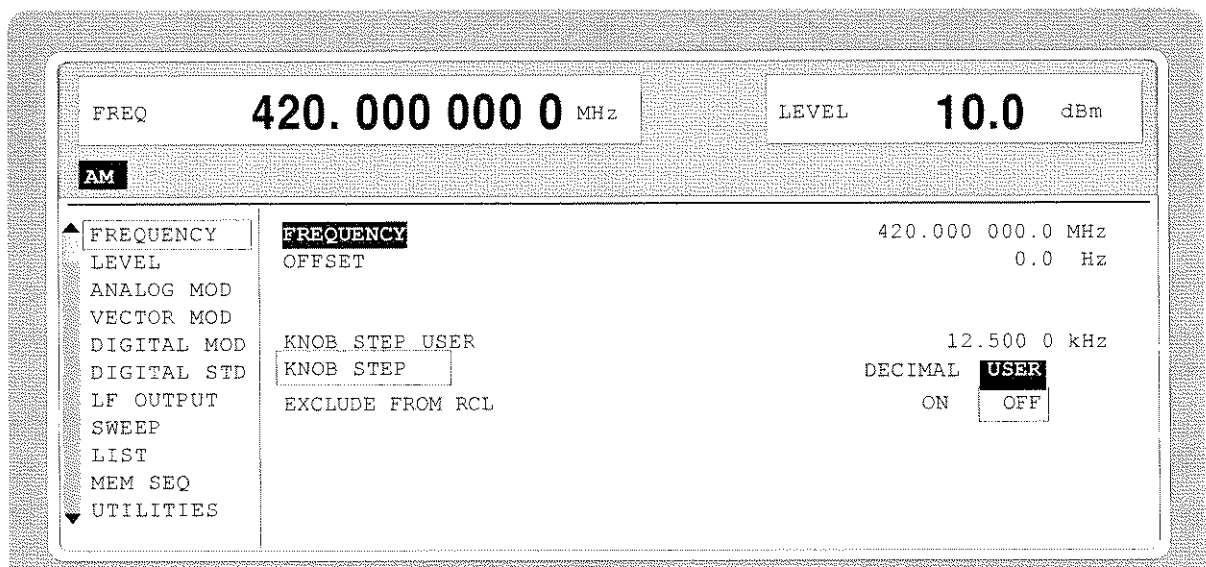

Fig. 2-6 Display after pattern setting

2.2.4 List Editor

The SMIQ offers the possibility to generate lists. Lists are used for setting sequences (LIST mode or memory sequence), as data source for digital modulations or for level correction which can be defined by the user (UCOR). They consist of elements which are defined by an index and at least one parameter per index. Each list is marked by a separate name and can be selected via this name. The lists are accessed in the menus assigned in each case, e.g. to the settings sequences of instrument settings in the MEM SEQ menu. However, the lists are always generated and processed in the same way and the procedures are hence explained in detail by the example of the memory sequence mode (menu MEM SEQ) in this section. A pattern setting at the end of this section allows the user to become familiar with the operation of the list editor.

Setting menus providing list processing are structured in two pages:

The first page, called OPERATION page in the following contains the general configuration parameters for processing a list. Further, the general list functions such as selecting and deleting the list as well as calling an editing mode are provided. The second page, the EDIT page, is automatically displayed when calling an edit function and serves to enter and modify the parameters of the list.

The OPERATION page has a similar arrangement with all list editors. As an example, the OPERATION page of the MEM SEQ menu is shown:

Menu selection: MEM SEQ

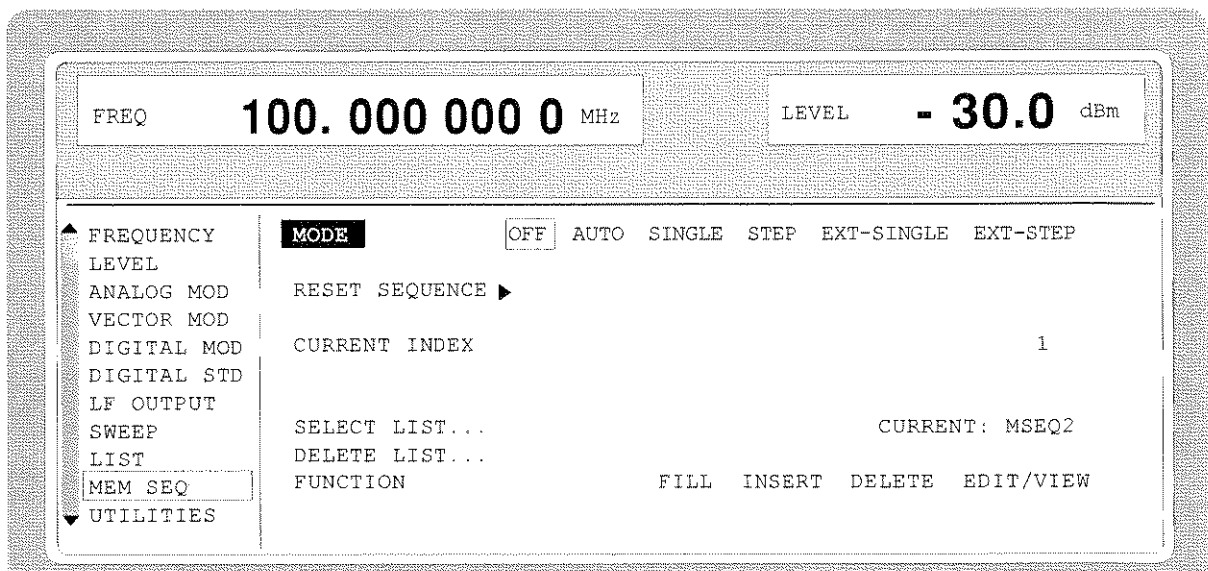

Fig. 2-7 OPERATION page of the MEM SEQ menu

The settings for MODE, CURRENT INDEX, etc. are irrelevant for the general description of the list editors and are described in greater detail in Section 2.10, MEMORY SEQUENCE mode.

The last three menu lines of the OPERATION page always exist and are reserved for selecting and deleting lists as well as for calling the edit functions (and hence the EDIT page)

SELECT LIST Opens a selection window in which a list can be selected from the existing lists or a new, empty list can be generated. In this line the active list is always displayed.

DELETE LIST Opens a selection window in which the list to be deleted can be selected..

FUNCTION	Selection of the edit function for processing the lists. The EDIT page is automatically called through the selection (cf. Section 2.2.4.3).
FILL	Filling a list with elements.
INSERT	Insertion of elements into a list.
DELETE	Deletion of elements of a list.

2.2.4.1 Select and Generate - SELECT LIST

SELECT LIST opens a selection window in which either an existing list can be selected or a new, empty list can be generated (cf. Fig. 2-8). By pressing the [RETURN] key, the selection window is closed without changing the setting.

- Select list
- Mark the list desired using the rotary knob.
 - Press [SELECT] key.
- The selected list is included in the instrument setting. The selection window is closed. The selected list is displayed under CURRENT.
- Generate list
- Mark CREATE NEW LIST ► using rotary knob.
 - Press [SELECT] key.
- A new empty list is automatically generated which can be filled using functions FILL or EDIT. The selection window is closed. The new list is displayed under CURRENT.
- No modification of the setting
- Press [RETURN] key.

Selection: SELECT LIST

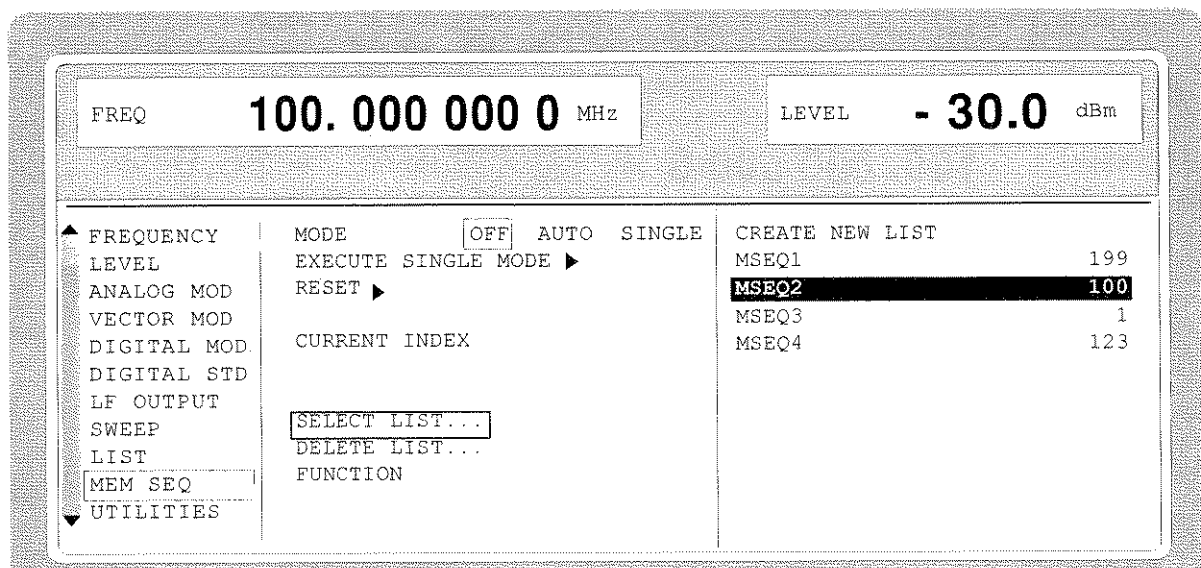

Fig. 2-8 SELECT-LIST-selection window

CREATE NEW LIST ► Generating a new list. The name of the list cannot be selected freely in the case of manual control. A definite list name is automatically generated in the following form:

MSEQ<n>, with <n> ∈ {0..9}, e.g. MSEQ1 (with Memory Sequence)

This applies correspondingly to the other operating modes. In the case of level correction mode, UCOR1 would be generated for example. If a list is created via IEC bus, an arbitrary list name can be given (cf. Section 3). Unrestricted access is also possible by means of the selection window.

MSEQ2 100

The list currently set is marked in the selection window by means of the selection mark, here SEQ2. In addition to the list name, the length of the list is given, here 100 elements.

2.2.4.2 Deletion of Lists - DELETE LIST

DELETE LIST opens a selection window in which the list to be deleted can be selected.. The lists are represented together with their name and their length (cf. Fig. 2-9). By pressing the [RETURN] key the selection window is exited without deleting a list.

Delete list

► Mark desired list using the rotary knob.

► Press [SELECT] key.

The prompt "enter [SELECT to delete list/sequence?" is displayed

► Press [SELECT] key.

The list is deleted. If the prompt is acknowledged with the [RETURN] key, however, the list is not deleted. The selection window is automatically closed due to the acknowledgment of the prompt.

Selection: DELETE LIST

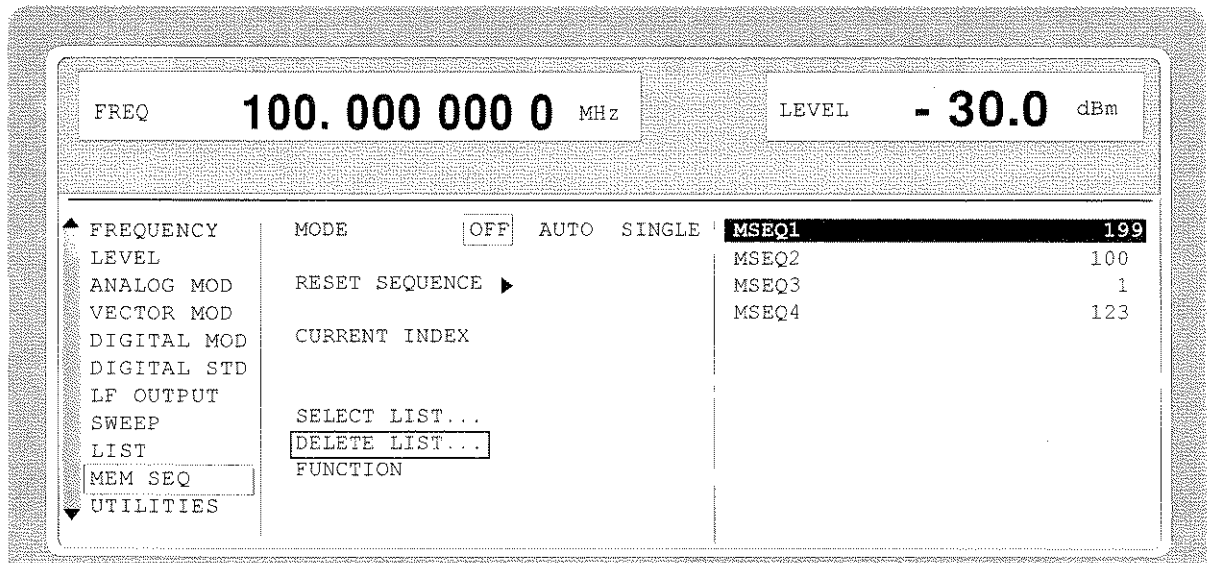

Fig. 2-9 DELETE-LIST selection window

2.2.4.3 Edition of Lists

Due to the selection of an edit mode on the OPERATION page the EDIT page is automatically activated. When the EDIT/VIEW function is selected, the largest possible section of the list is displayed (cf. Fig. 2-10). In the case of block functions FILL, INSERT and DELETE, an input window is additionally displayed (cf. Fig. 2-11 to 2-13).

Functions SELECT LIST and FUNCTION are available on the EDIT page as on the OPERATION page. Return to the OPERATION page is effected by pressing the [SELECT] key twice.

Single-value function EDIT/VIEW

By selecting the EDIT/VIEW function, the entire list can be viewed or modifications of single values be carried out.

If the cursor marks a value in the INDEX column of the list, the EDIT mode is exited by pressing the [RETURN] key. The menu cursor then marks FUNCTION again.

There is no separate function for storing the list. This means that every modification of the list is transferred to the internal data set and has an effect on exiting the EDIT/VIEW function.

Selection: FUNCTION EDIT/VIEW

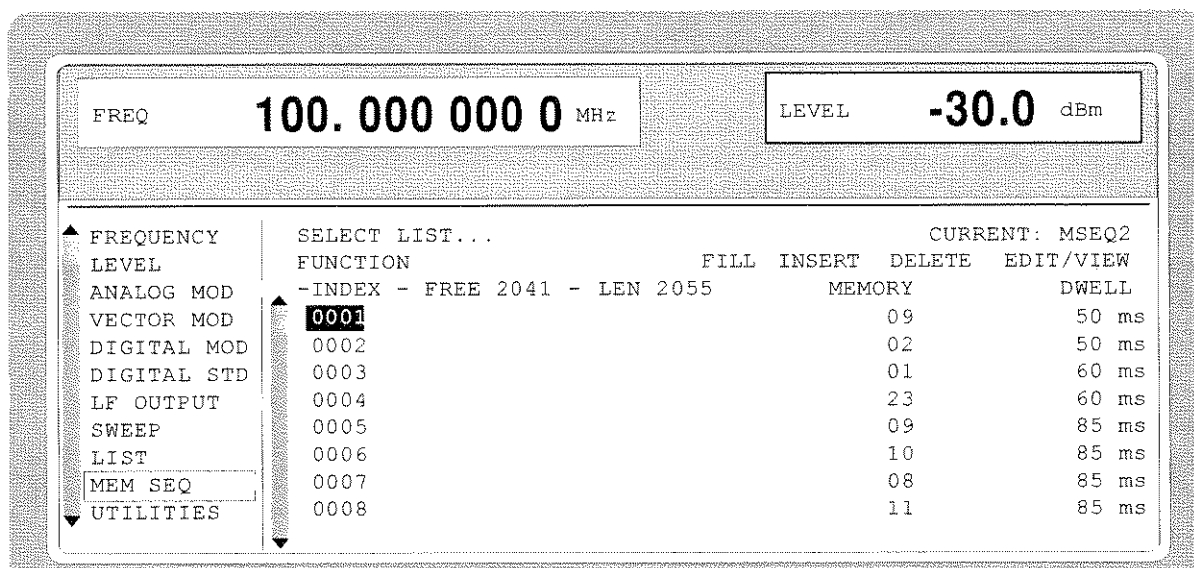

Fig. 2-10 Edit function EDIT/VIEW

INDEX	Position in the list
FREE	Space available. FREE 2041 means that space for 2041 parameter elements is available in the list memory in total.
LEN	Occupied space. LEN 2055 means that the current list occupies 2055 elements in the list memory.
MEMORY DWELL	Identification of the column below. The number and name of parameter columns is different for the various list editors.

- Select parameters
- Mark the index associated to the parameter using the rotary knob or directly enter the value of the index via the numeric keys.
 - Press [SELECT] key.
Parameter MEMORY is marked. If the second parameter DWELL is to be marked, press the [SELECT] key again.
- Modify parameters
- Vary the value of the parameter selected using the rotary knob or enter the value directly using numeric keys.
- Note:** The binary data of the digital modulations which cannot be varied are an exception. Further, all numeric keys except for "0" and "1" are ineffective in these cases.
- Press the [ENTER] key or unit keys.
The value is included in the data set. The menu cursor marks the value of the next column. In the last column, the menu cursor then marks the next line of column MEMORY.
 - Press the [RETURN] key.
The menu cursor wraps back to the INDEX column. The EDIT mode is exited by repeatedly pressing the [RETURN] key (cf. Section 2.2.4.4).

Block function FILL

Using function FILL, a parameter, e.g. MEMORY, is overwritten with constant or linearly increasing/decreasing values within a defined range. The input window is exited by pressing the [RETURN] key without a modification being carried out.

If the filler range exceeds the end of the list, the list is automatically extended.

The list entry, in the example for MEMORY, with index [AT +n] is calculated as follows from the information AT, RANGE, starting value (MEMORY) and WITH INCREMENT:

$$\text{MEMORY[AT+n]} = \text{starting value (MEMORY)} + n \cdot \text{increment} \quad | \quad (0 \leq n \leq \text{RANGE1})$$

Selection: FUNCTION-FILL

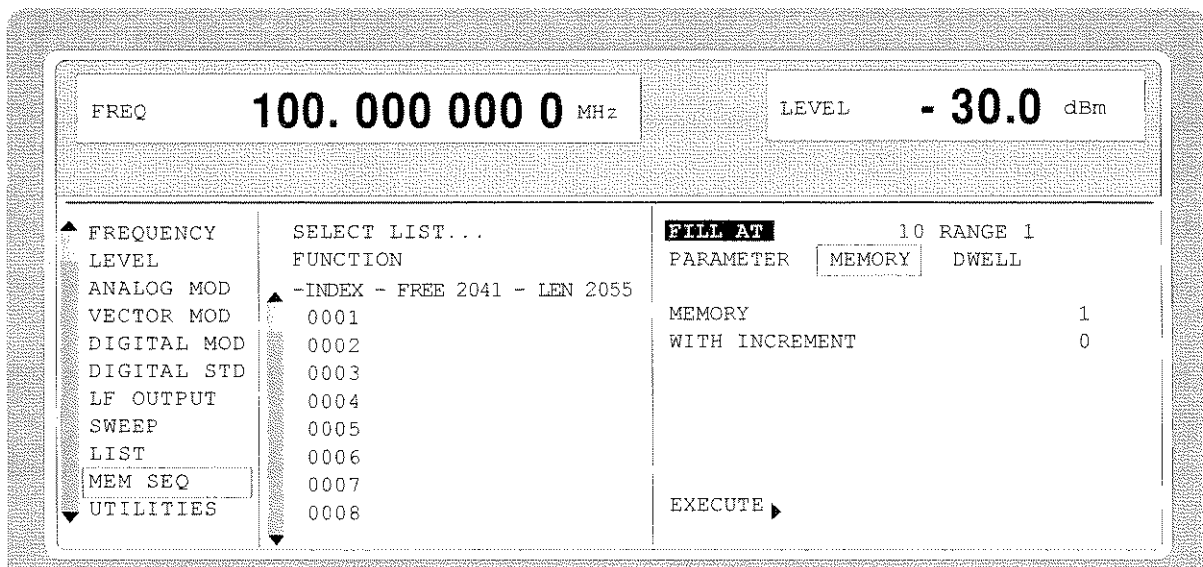

Fig. 2-11 Block function FILL: Input window

- FILL AT** Setting the filling range.
 AT Lower limit (index)
 RANGE Number of the elements to be inserted
- PARAMETER** Selection on which of the parameters the filling function is to have an effect. This menu option is eliminated if the list only includes elements with one parameter.
- MEMORY or DWELL** Input of the starting value for the parameter selected. This option is only displayed if a selection has been made under PARAMETER MEMORY or DWELL.
- WITH INCREMENT** Input of the increment between two successive values. If 0 is entered as increment, a filling procedure with constant values is achieved. This option is only displayed if a selection has been made under PARAMETER MEMORY or DWELL.
***Note:** In the case of some types of lists, e.g. digital modulation data, indicating an increment is eliminated since there are binary data. In these cases line WITH INCREMENT is eliminated.*
- EXECUTE ►** Starts the filling sequence. After the function has been executed, the input window is automatically exited. The current index points to the first element after the processed range.

Filling a list

After selection of function FILL, the menu cursor marks FILL AT.

- Press the [SELECT] key.
The menu cursor marks the value at AT.
- Vary index value using the rotary knob or enter using the numeric keys and the [ENTER] key.
- Press the [SELECT] key.
The menu cursor marks the value at RANGE.
- Vary value using the rotary knob or enter using the numeric keys and the [ENTER] key.
- Press the [SELECT] key.
The menu cursor marks MEMORY or DWELL in input line PARAMETER.
- Select MEMORY using the rotary knob (if not yet marked) and press the [SELECT] key.
The menu cursor marks the value in input line MEMORY.
- Vary starting value for column MEMORY using the rotary knob or enter using the numeric keys and the [ENTER] key.
- Press the [SELECT] key
The menu cursor marks the value in input line WITH INCREMENT.
- Vary the value of the increment desired using the rotary knob or enter using the numeric keys and the [ENTER] key.
- Press the [RETURN] key.
- Mark the action EXECUTE ►
- Press the [SELECT] key.
The filling sequence is initiated. After the function has been carried out, the input window is automatically exited. The menu cursor marks FUNCTION.
The EDIT page shows the end of the range that has been filled right now.

Block function INSERT

Function INSERT inserts the desired number of elements with constant or linearly increasing/de-creasing values before the element with the given starting index. All elements which had been stored from the starting index are shifted to the end of the range to be inserted.

Input is effected analogously to filling a list.

By pressing the [RETURN] key the input window is exited without a modification being effected. The menu cursor then marks FUNCTION.

The list entry, in the example for MEMORY, with index [AT +n] is calculated as follows from the information AT, RANGE, starting value (MEMORY) and WITH INCREMENT:

$$\text{MEMORY[AT+n]} = \text{starting value (MEMORY)} + n \cdot \text{Increment} \quad | \quad (0 \leq n \leq \text{RANGE}-1)$$

Selection: FUNCTION INSERT

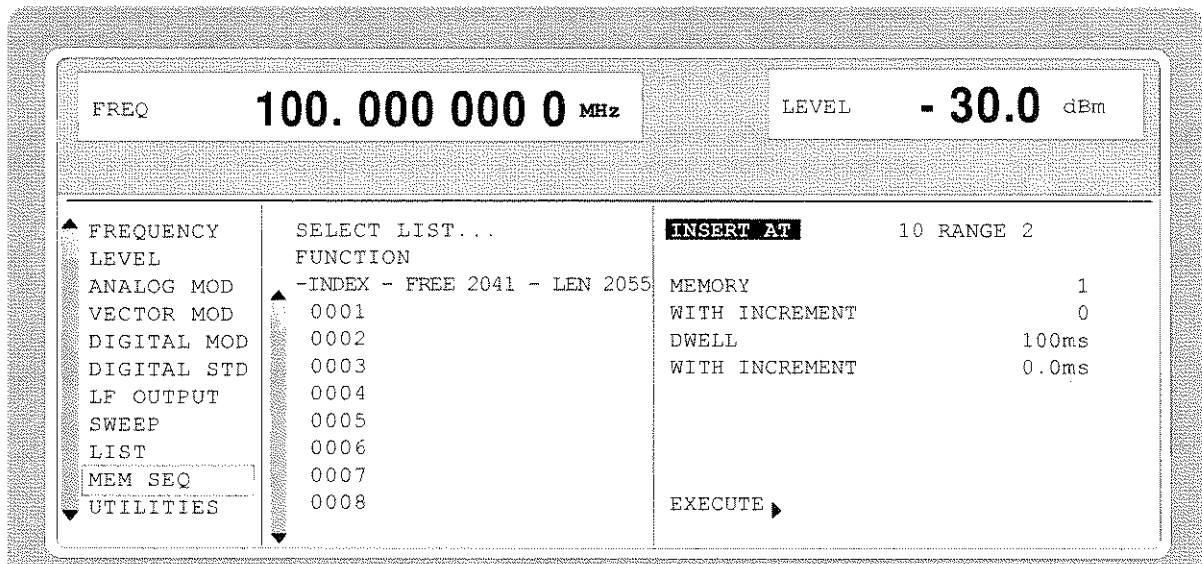

Fig. 2-12 Edit function INSERT: Input window

INSERT AT

Input of the starting index and the number of the elements to be inserted.

AT Starting index before which the insert operation is to be effective.

RANGE Number of the elements to be inserted

MEMORY

Input of the starting value for MEMORY.

DWELL

Input of the starting value for DWELL.

WITH INCREMENT

Input of the increment between two successive values for MEMORY or DWELL. If 0 is indicated as increment, constant values are achieved to be inserted RANGE times.

Note: In the case of some types of lists, e.g. digital modulation data, indicating an increment is eliminated since there are binary data. In these cases all lines WITH INCREMENT are eliminated.

EXECUTE ►

Starts the inserting sequence. After the function has been executed, the input window is automatically exited. The menu cursor marks FUNCTION. The EDIT page shows the beginning of the range that has moved forward.

Block function DELETE

Function DELETE deletes the elements of the range indicated. This does not leave a gap in the list but the remaining elements move forward. If the given range exceeds the end of the list, deletion until the end of the list is effected.

Input is analog to filling a list.

By pressing the [RETURN] key, the input window is exited without a modification being carried out. The menu cursor then marks FUNCTION.

Selection: Function DELETE

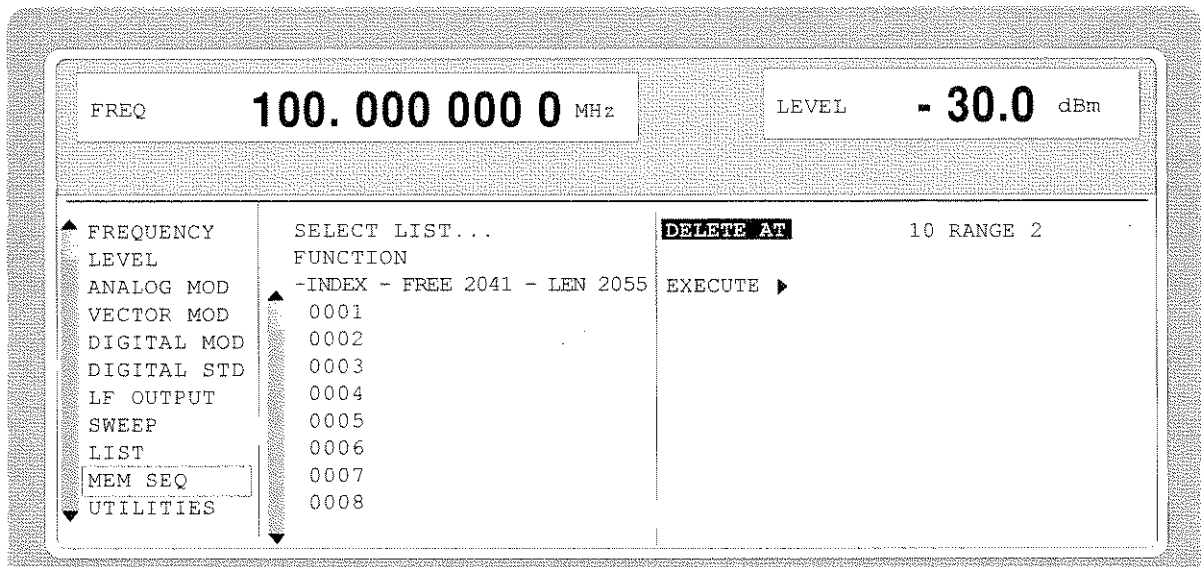

Fig. 2-13 Edit function DELETE: Input window

DELETE AT Input of the block of the list to be deleted
 AT Lower limit (INDEX)
 RANGE Number of elements to be deleted.

EXECUTE ► Starts the deletion. After the function has been executed, the input window is automatically exited. The menu cursor marks FUNCTION. The EDIT page shows the beginning of the range that has moved forward.

2.2.4.4 Pattern Setting to Operate the List Editor

The user can become familiar with the operation of the list editor by means of the following pattern setting in the MEM SEQ menu. List MSEQ2 shall be changed using the single-value function EDIT/VIEW:

- Memory location number of the first element 20
- Dwell time of the first element 15s
- Memory location number of the second element 7.

When the setting has been terminated, return to the OPERATION page of the MEM SEQ menu.

At the beginning of the operation sequence, menu MEM SEQ is called. List MSEQ2 is active. The menu cursor marks a parameter of the setting menu on the OPERATION page (c.f. Fig. 2-14).

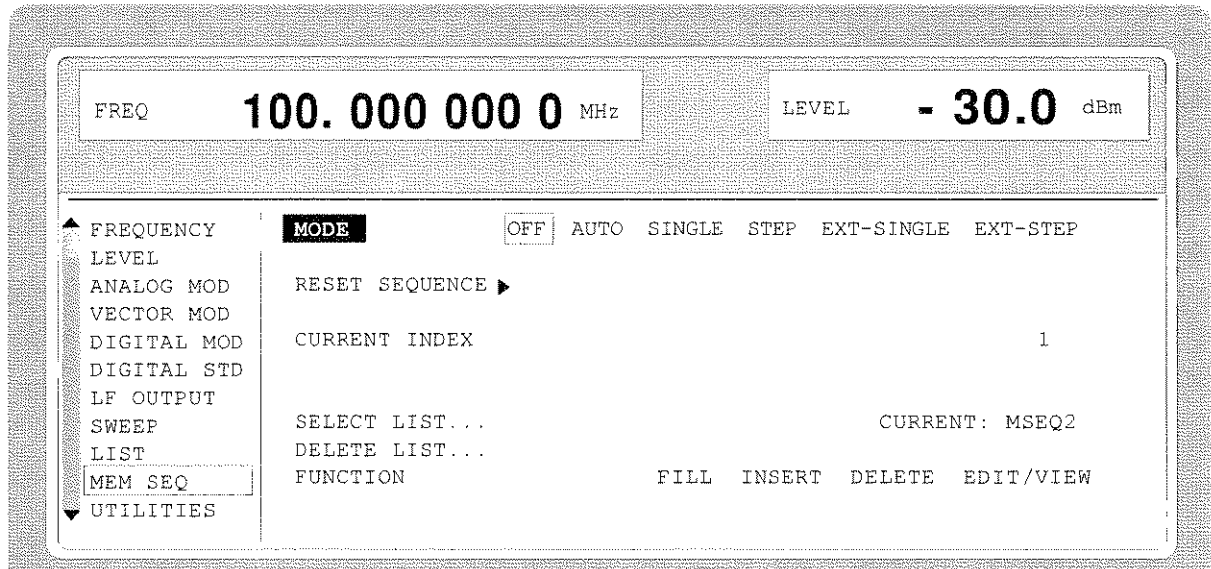

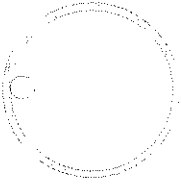



Fig. 2-14 Starting point of the pattern setting

Operating steps		Explanations
<p>MENU / VARIATION</p>  <p>FUNCTION...</p>	<p>MENU / VARIATION</p> 	<p>Select the FUNCTION menu item.</p>
<p>MENU / VARIATION</p>  <p>.EDIT VIEW.</p>	<p>MENU / VARIATION</p> 	<p>Select single-value function EDIT/VIEW. The EDIT page of the MEM SEQ menu is called. The menu cursor marks the index of the first element of list SEQ2.</p>
		<p>Set the menu cursor to the memory location number value of the first element (c.f. Fig. 2-15,A).</p>

Operating steps	Explanations
<p>DATA INPUT</p> <p>2 0 x1 ENTER</p>	<p>Enter MEMORY 20.</p> <p>The menu cursor automatically wraps to the DWELL value of the first element (Fig. 2-15,B).</p>
<p>DATA INPUT</p> <p>1 5 x1 ENTER</p>	<p>Enter DWELL 15 s.</p> <p>The menu cursor automatically wraps to the MEMORY value of the second element.</p>
<p>DATA INPUT</p> <p>7 x1 ENTER</p>	<p>Enter MEMORY 7.</p> <p>The menu cursor automatically wraps to the DWELL value of the second element.</p>
<p>RETURN</p>	<p>Reset the menu cursor to the index.</p>
<p>RETURN</p>	<p>Reset the menu cursor to the FUNCTION menu item of the EDIT page of menu MEM SEQ (c.f. Fig. 2-15,C).</p>
<p>RETURN</p>	<p>Reset the menu cursor to the FUNCTION menu item of the OPERATION page of menu MEM SEQ.</p>

Note: With the return to the OPERATION page the operation of the list editor is finished. In the list mode (menu LIST), function LEARN ► must be activated subsequently to ensure that the settings are transferred to the hardware.

A

FREQ **100.000 000 0** MHz

LEVEL **- 30.0** dBm

▲ FREQUENCY	SELECT LIST...	CURRENT: MSEQ2			
LEVEL	FUNCTION	FILL	INSERT	DELETE	EDIT/VIEW
ANALOG MOD	-INDEX - FREE 0246 - LEN 0010				
VECTOR MOD	0001			09	50 ms
DIGITAL MOD	0002			02	1.000 s
DIGITAL STD	0003			01	60 ms
LF OUTPUT	0004			23	60 ms
SWEEP	0005			09	1.000 s
LIST	0006			10	1.000 s
MEM SEQ	0007			08	1.000 s
▼ UTILITIES	0008			11	1.000 s

B

FREQ **100.000 000 0** MHz

LEVEL **- 30.0** dBm

▲ FREQUENCY	SELECT LIST...	CURRENT: MSEQ2			
LEVEL	FUNCTION	FILL	INSERT	DELETE	EDIT/VIEW
ANALOG MOD	-INDEX - FREE 0246 - LEN 0010				
VECTOR MOD	0001			20	50 ms
DIGITAL MOD	0002			02	1.000 s
DIGITAL STD	0003			01	60 ms
LF OUTPUT	0004			23	60 ms
SWEEP	0005			09	1.000 s
LIST	0006			10	1.000 s
MEM SEQ	0007			08	1.000 s
▼ UTILITIES	0008			11	1.000 s

C

FREQ **100.000 000 0** MHz

LEVEL **- 30.0** dBm

▲ FREQUENCY	SELECT LIST...	CURRENT: MSEQ2			
LEVEL	FUNCTION	FILL	INSERT	DELETE	EDIT/VIEW
ANALOG MOD	-INDEX - FREE 0246 - LEN 0010				
VECTOR MOD	0001			20	15.00 s
DIGITAL MOD	0002			07	1.000 s
DIGITAL STD	0003			01	60 ms
LF OUTPUT	0004			23	60 ms
SWEEP	0005			09	1.000 s
LIST	0006			10	1.000 s
MEM SEQ	0007			08	1.000 s
▼ UTILITIES	0008			11	1.000 s

Fig. 2-15, a to c Pattern setting - Edition of a list

2.2.5 Save/Recall - Storing/Calling of Instrument Settings

50 complete instrument settings can be stored in memory locations 1 to 50.

Operating steps	Explanations
<p style="text-align: center;">DATA INPUT</p> <div style="display: flex; justify-content: space-around; align-items: center;"> <div style="border: 1px solid black; padding: 2px 5px;">SAVE</div> <div style="border: 1px solid black; padding: 2px 5px;">1</div> <div style="border: 1px solid black; padding: 2px 5px;">2</div> <div style="border: 1px solid black; padding: 2px 5px;">x1 ENTER</div> </div>	<p>Store current instrument setting in memory location 12.</p>
<p style="text-align: center;">DATA INPUT</p> <div style="display: flex; justify-content: space-around; align-items: center;"> <div style="border: 1px solid black; padding: 2px 5px;">RCL</div> <div style="border: 1px solid black; padding: 2px 5px;">1</div> <div style="border: 1px solid black; padding: 2px 5px;">2</div> <div style="border: 1px solid black; padding: 2px 5px;">x1 ENTER</div> </div>	<p>Call instrument setting of memory location 12.</p>

The digital display during a save or recall entry is faded in a window.

Memory location 0 has a special function. Here the instrument setting which was current prior to the last memory recall and prior to a preset setting is automatically stored. This permits the resetting of instrument settings which have inadvertently been deleted using Recall 0.

If an instrument setting is stored in which a sweep was switched on, the sweep is started using the recall.

The parameter EXCLUDE FROM RCL in the FREQUENCY and LEVEL-LEVEL menus determines whether the saved RF frequency and RF level are loaded when an instrument setting is loaded, or whether the current settings are maintained.

Store IEC-bus command: ****SAV 12"**

Call IEC-bus command: ****RCL 12"**

- Notes:**
- *The contents of lists, as they are used for the Memory Sequence (MSEQ) or for user correction (UCOR), is not saved in the SAVE memory. It is stored under the respective list name and can be called.*
 - *The frame configurations (digital standards PHS, NADC, PDC, GSM) and the channel configurations (digital standard CDMA) are not stored in the SAVE memory either. These settings can be stored and loaded via menu items SAVE/RCL FRAME and SAVE/RCL MAPPING in the corresponding DIGITAL STD menus.*
 - *If instrument settings are called which go back to list data such as level setting using UCOR, the current list contents is used. If this has been altered, it is not identical to the list contents at the point of storing any more.*
 - *Model SMIQ03A and units that are equipped with option Fast CPU for SMIQ, SM-B50, comprise the "Fast Restore" mode for very fast loading of stored device settings. This mode can be called up only during remote control (see section 3, "Fast Restore Mode".)*

2.3 Menu Summary

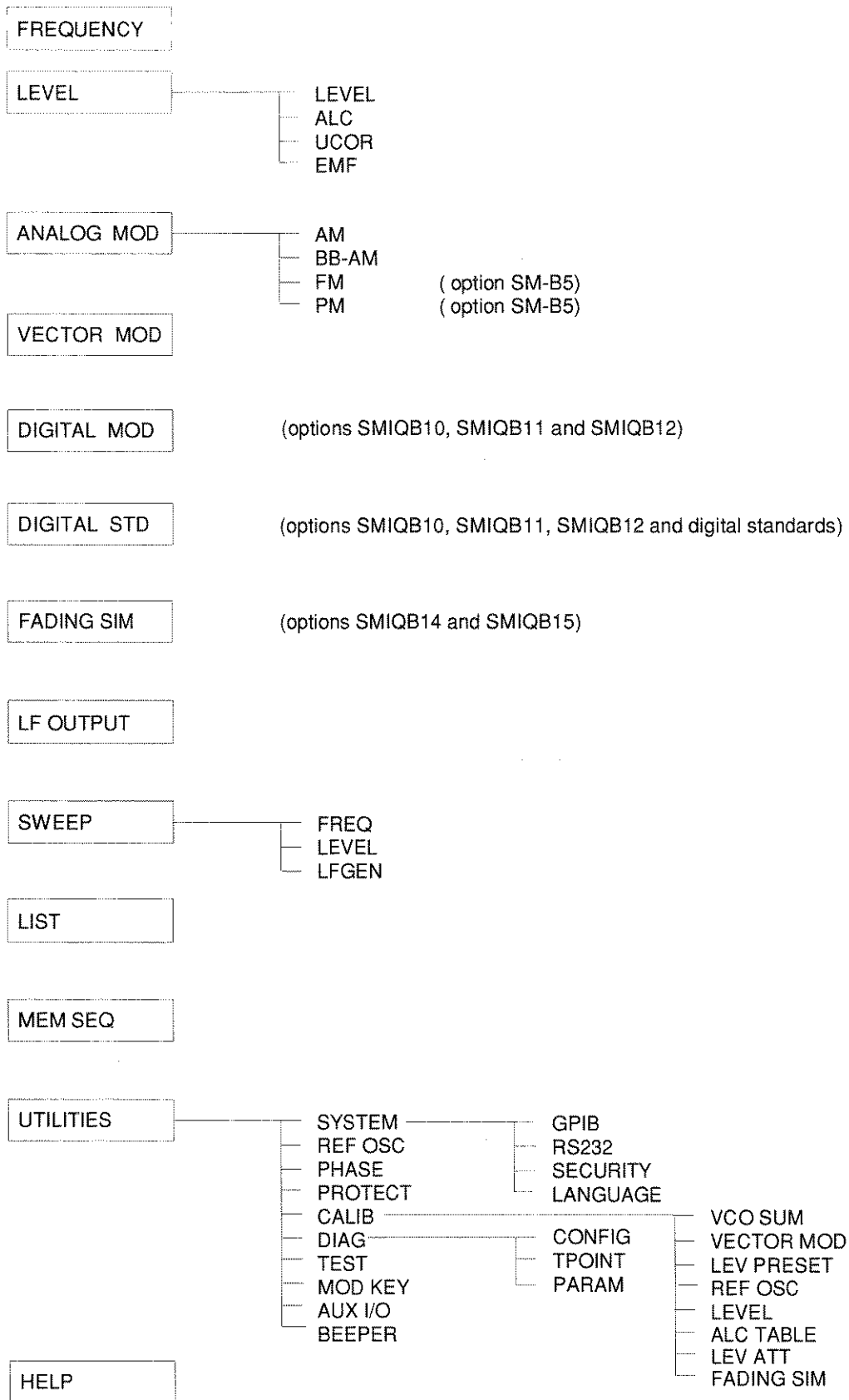

2.4 RF Frequency

The frequency of the RF output signal can be set directly using the [FREQ] key (cf. Section 2.2.2.5) or by accessing menu FREQUENCY.

In the header field of the display, the frequency of the RF output signal is indicated under FREQ.

In the case of frequency settings opened by means of the [FREQ] key, the value entered directly is the frequency of the RF output signal.

The input value of frequency settings effected in the FREQUENCY menu considers the offset in calculation (cf. next Section). This offers the possibility of entering the desired output frequency of possibly series-connected instruments such as mixers in the menu.

<i>Note:</i>	<i>Further settings:</i>	<i>Frequency sweep</i>	<i>Menu SWEEP</i>
		<i>LF frequency</i>	<i>Menu ANALOG MOD</i>
			<i>Menu LF-OUTPUT</i>
		<i>int./ext. reference frequency</i>	<i>Menu UTILITIES-REF OSC</i>
		<i>Phase of the output signal</i>	<i>Menu UTILITIES-PHASE</i>

Menu selection: FREQUENCY

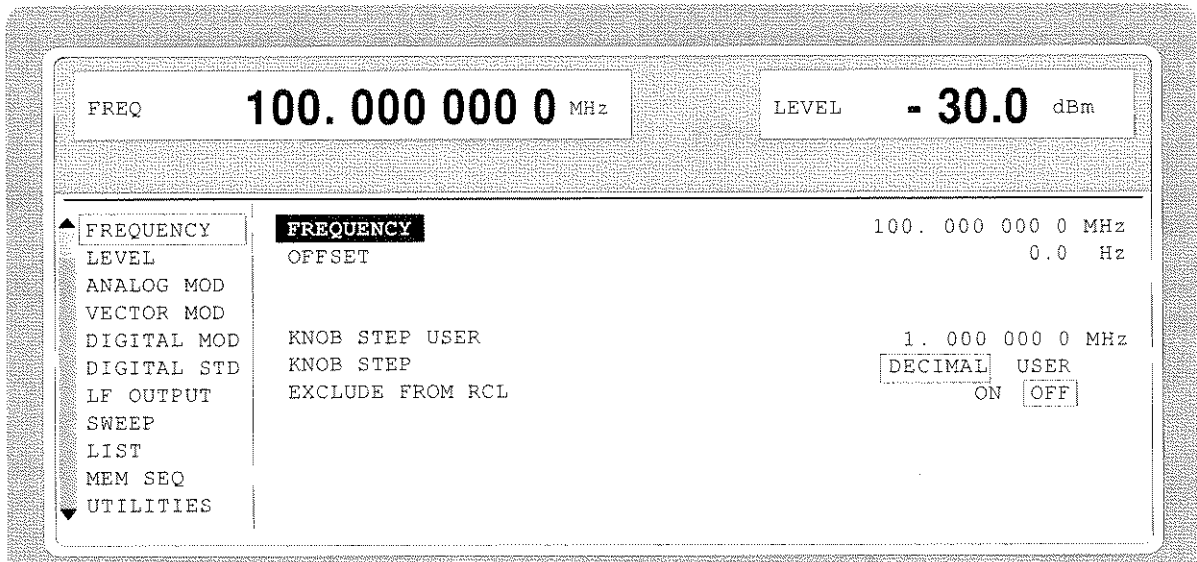

Fig. 2-16 Menu FREQUENCY (preset setting)

FREQUENCY Input value of the RF frequency considering the OFFSET input value. The frequency of the RF output signal is determined by input values FREQUENCY and OFFSET (cf. Section "Frequency Offset").

IEC/IEEE-bus command SOUR:FREQ 100E6

OFFSET Input value of the frequency offset, e.g., of a series-connected mixer (cf. Section "Frequency Offset").

IEC/IEEE-bus command SOUR:FREQ:OFFS 0

KNOB STEP USER Input value of the step width for frequency variation using the rotary knob. The RF frequency is varied in the step width entered if KNOB STEP is set to USER.

IEC/IEEE-bus command SOUR:FREQ:STEP 1MHz

KNOB STEP	DECIMAL:	Variation step width corresponding to the position of the digit cursor.
	USER:	"User Defined", variation step width as entered under KNOB STEP USER .
EXCLUDE FROM RCL	OFF	The saved frequency is also loaded when instrument settings are loaded with the [RECALL] key or with a memory sequence. IEC/IEEE-bus command <code>SOUR:FREQ:RCL INCL</code>
	ON	The RF frequency is not loaded when instrument settings are loaded, the current frequency is maintained. IEC/IEEE-bus command <code>SOUR:FREQ:RCL EXCL</code>

2.4.1 Frequency Offset

The SMIQ offers the possibility of entering an offset (OFFSET) of possibly series-connected instruments in the FREQUENCY menu. The indication/input value under FREQUENCY considers this input and represents the frequency value of the RF signal at the output of these instruments (cf. Fig. 2-17).

Input values FREQUENCY and OFFSET have the following connection with the frequency of the RF output signal:

$$\text{FREQUENCY} - \text{OFFSET} = \text{RF output signal.}$$

An offset input does not cause a variation of the RF output signal, but only a variation of indication value FREQUENCY in the FREQUENCY menu.

The RF output frequency of the SMIQ is indicated in the header field of the display. It can be entered directly, i.e. without considering the offset using the [FREQ] key.

The offset setting also remains effective with the frequency sweep.

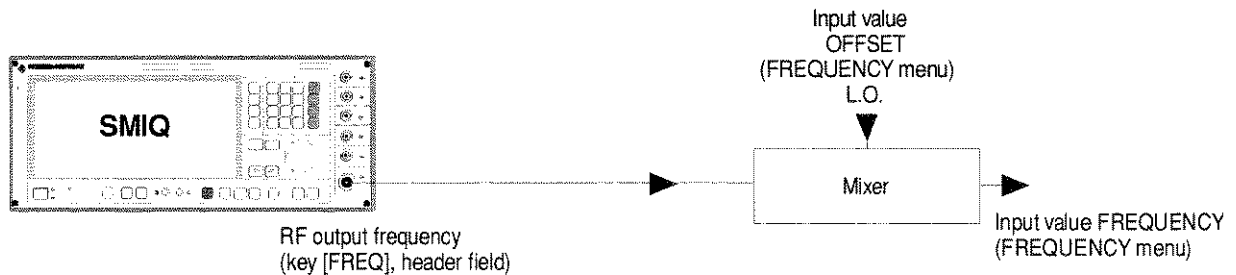

Fig. 2-17 Example of a circuit with frequency offset

2.5 RF Level

The RF output level can be set directly using the [LEVEL] key (cf. Section 2.2.2.5) or by accessing the LEVEL menu.

In the header field of the display, the set RF output level is indicated under LEVEL. A two-line level display appears for digital modulation or digital standard. The upper line indicates the average power (LEVEL), the lower line the peak envelope power (PEP) of the modulated RF output signal.

The input value of level settings opened using the [LEVEL] key directly corresponds to the RF output level.

The input value of the level settings effected in the LEVEL-LEVEL menu mathematically considers the offset of an attenuation/amplification element which is possibly series-connected (cf. Section 2.5.1). This offers the possibility of entering the desired level at the output of series-connected instruments, the SMIQ then alters the RF output level correspondingly. The offset can also be entered in the LEVEL-LEVEL menu.

dBm, dB μ V, mV and μ V can be used as level units. The 4 unit keys are directly labeled with these units. In order to change to another level unit, simply press the desired unit key.

- Notes:**
- The message *ERROR* is displayed in the status line if the level set in the overrange is not reached.
 - For digital modulation or digital standard, a *WARNING* message appears in the status line if the set LEVEL or the displayed PEP are overranged. If the set level cannot be generated as an overrange value, *ERROR* will be displayed.
 - Further settings: Level sweep menu *SWEEP*

Menu selection: LEVEL - LEVEL

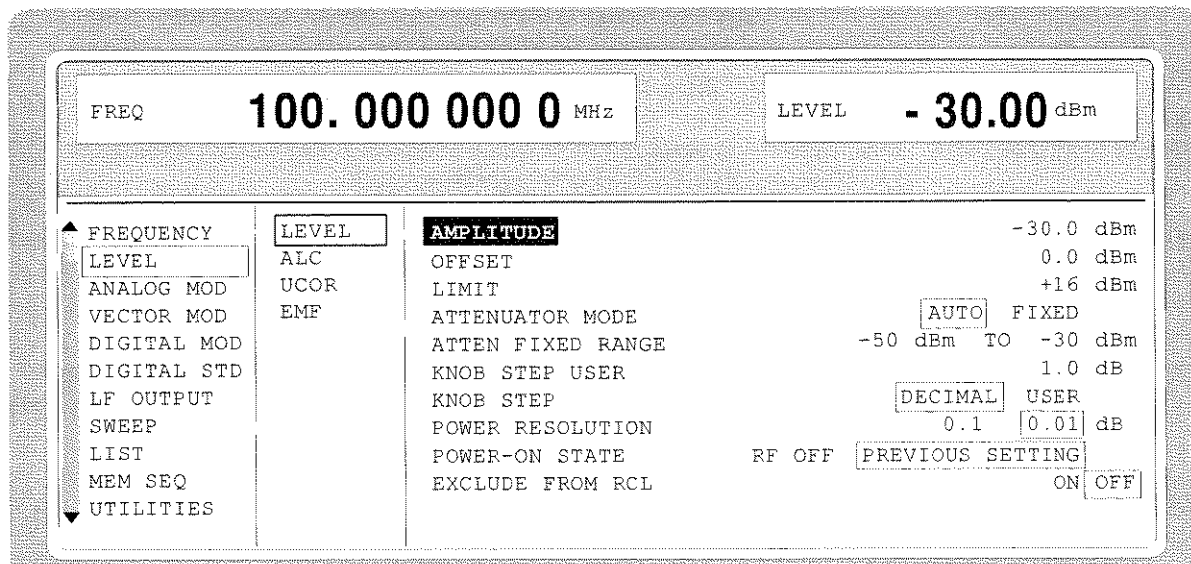

Fig. 2-18 Menu LEVEL (preset setting) POWER RESOLUTION is set to 0.01 dB

AMPLITUDE

Input value of the RF level considering the OFFSET input value. The level of the RF output signal is determined by input values AMPLITUDE and OFFSET (cf. Section 2.5.2, Level Offset).

IEC/IEEE-bus command SOUR:POW 30

OFFSET	Input value of the level offset of the RF output level compared to the input value of the RF level indicated in the LEVEL menu. Input in dB (cf. Section 2.5.1, Level Offset). IEC/IEEE-bus command SOUR:POW:OFFS 0
LIMIT	Input value of level limitation. This value indicates the upper limit of the level at the RF output connector. If a level above this limit is attempted to be set, a warning is displayed in the status line. IEC/IEEE-bus command SOUR:POW:LIM 16 dBm
ATTENUATOR MODE	<p>AUTO Normal operation. The attenuator switching mechanically switches in steps of 5 dB, the switching points being fixed. IEC/IEEE-bus command :OUTP:AMOD AUTO</p> <p>FIXED Level settings are made in a range of somewhat over 20 dB without switching the attenuator (see section 2.5.2, "Non-interrupting Level Setting"). The range of variation is fixed automatically upon selection of this operating mode. The range is indicated in the ATTEN FIXED RANGE menu. With level settings out of the indicated range, a warning is displayed. IEC/IEEE-bus command :OUTP:AMOD FIX</p> <p>ELECTRONIC Level settings are made in a range of somewhat over 90 dB without switching the attenuator (see section 2.5.2, "Non-interrupting Level Setting"). The range of variation is fixed automatically upon selection of this operating mode. The range is indicated in the ATTEN FIXED RANGE menu. With level settings out of the indicated range, a warning is displayed. This function is only available if the IQMOD module of version VAR 4 or higher is installed (indication in UTILITIES - DIAG - CONFIG menu, IQMOD Var 4 required). IEC/IEEE-bus command :OUTP:AMOD ELEC</p>
ATTEN FIXED RANGE	Indication of the level range in which the level is set without interruption in the "ATTENUATOR MODE FIXED" operating mode.
KNOB STEP USER	Input value of the step width for level variation using the rotary knob. The RF level is varied in the step width entered if KNOB STEP is set to USER. IEC/IEEE-bus command SOUR:POW:STEP 1
KNOB STEP	<p>DECIMAL Variation step width according to the position of the digit cursor.</p> <p>USER User Defined, variation step width as entered under KNOB STEP USER.</p>
POWER RESOLUTION	Selection of resolution of LEVEL display. For level range -99.9 dBm to +16 dBm the resolution for the level display can be set to 0.1 dB or 0.01 dB.
POWER-ON STATE	<p>Selection of the state the RF output is to assume after power-on of the unit</p> <p>RF OFF Output is switched off</p> <p>PREVIOUS SETTING Same state as before switch-off</p> <p>IEC/IEEE-bus command :OUTP:PON ON</p>

EXCLUDE FROM RCL	OFF	The saved RF level is also loaded when instrument settings are loaded with the [RECALL] key or with a memory sequence. IEC/IEEE-bus command SOUR:POW:RCL INCL
	ON	The RF level is not loaded when instrument settings are loaded, the current level is maintained. IEC/IEEE-bus command SOUR:POW:RCL EXCL

2.5.1 Level Offset

The SMIQ offers the possibility of entering the offset (OFFSET) of a possibly series-connected attenuator/amplification element in the LEVEL-LEVEL menu. The indication/input value under AMPLITUDE considers this input (see below) and represents the level value of the signal at the output of the series-connected instrument (cf. Fig. 2-19).

Input values LEVEL and OFFSET in the LEVEL menu have the following connection with the RF output level:

$$\text{AMPLITUDE} - \text{OFFSET} = \text{output level}$$

An offset input does not effect an alteration of the RF output level, but only an alteration of the LEVEL indication value in the LEVEL menu. The offset is to be entered in dB.

The RF output level of the SMIQ is indicated in the header field of the display. It can be entered directly, i.e. without considering an offset, using the [LEVEL] key.

The offset setting also remains effective in the ATTENUATOR MODE FIXED operating mode and with level sweep.

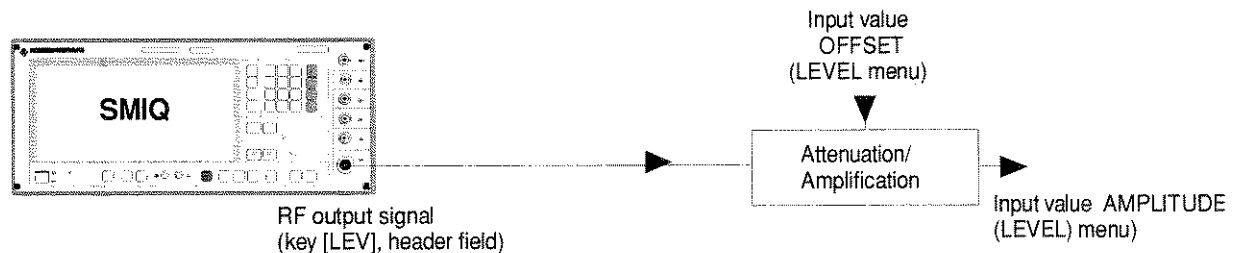

Fig. 2-19 Example of a circuit with level offset

2.5.2 Interrupt-free Level Setting

In the ATTENUATOR MODE FIXED and ATTENUATOR MODE ELECTRONIC operating modes, level settings are carried out without interruption. The attenuator is switched electronically rather than mechanically.

The MODE FIXED variation range is somewhat over 20 dB, the variation range of MODE ELECTRONIC over 90 dB. In case of over- or underranging of the normal variation range, level errors strongly increase and an under/overrange warning is displayed. At high attenuation values the spectral purity of the output signal is degraded.

The ATTENUATOR MODE ELECTRONIC mode is only possible with level control switched off. The ALC OFF mode is automatically set to TABLE.

Note: To ensure highest level accuracy in ATTENUATOR MODE ELECTRONIC mode, the self calibration routines ALC TABLE and LEV ATT should be called up in the UTILITIES - CALIB menu after temperature variations of more than 5 degrees.

The MODE ELECTRONIC cannot be used either simultaneously with the SLOT ATTENUATION function of the digital standards. This applies to all TDMA standards. The MODE ELECTRONIC cannot be used either simultaneously with the DIGITAL MOD - POWER RAMP CONTROL - ATTENUATION function.

2.5.3 Switching On/Off Internal Level Control

The LEVEL - ALC menu allows the level control to be switched on and off for special applications. In the normal operating mode for CW, AM and FM(PM), level control is switched on so that an optimum level accuracy is obtained. For vector modulation or digital modulation, level control must normally be off. In this case the SAMPLE&HOLD or the TABLE mode can be selected instead.

In the SAMPLE&HOLD mode the level is recalibrated after each level or frequency setting. To do this, CW is selected for a short period of time, level control is switched on and the level control held at the value attained. If this calibration procedure is not desired, the TABLE mode (level control voltage taken from a table) can be selected. In this mode the correction values required after a frequency or level change are obtained from a table. With the LEARN TABLE ► function called up, a new table can be prepared without any additional measuring instruments being required.

The preset level control is AUTO. Level control in this mode is automatically adapted to the operating conditions. For special applications, level control can be held in the OFF or ON state. Level control OFF is useful for improving the intermodulation suppression in multi-signal measurements in the CW mode. The ON setting is recommended if vector modulation or digital modulation with a constant envelope curve is required.

Menu selection: LEVEL - ALC

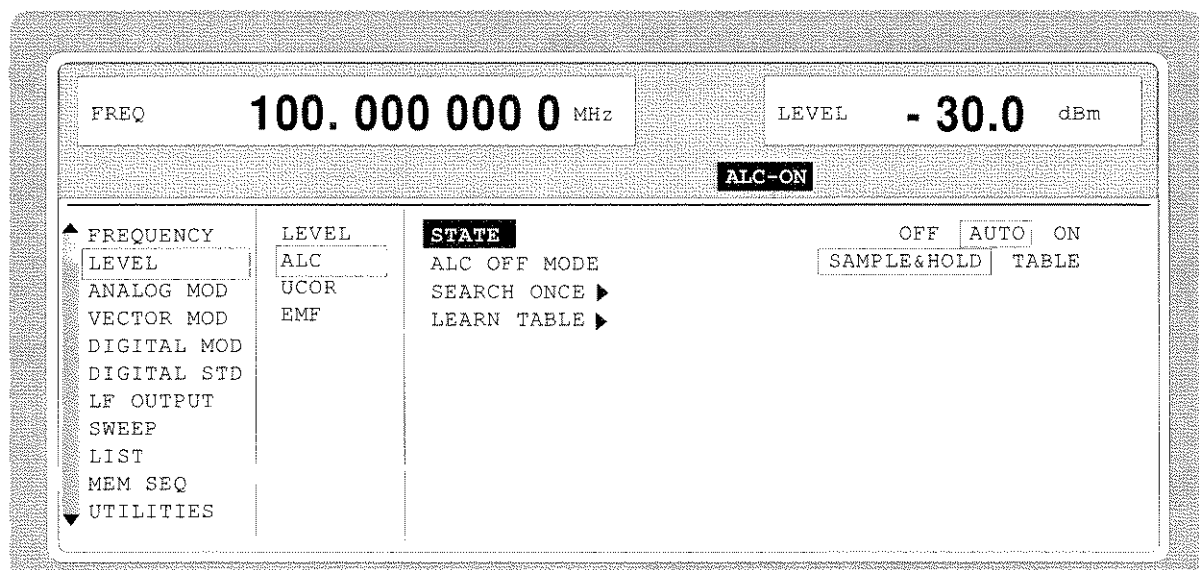

Fig. 2-20 Menu LEVEL - ALC (preset setting)

STATE	OFF	Internal level control is deactivated. In this state no AM is possible . IEC/IEEE-bus command SOUR:POW:ALC OFF
	AUTO	Normal state. The internal level control is automatically adjusted to the operating conditions. IEC/IEEE-bus command SOUR:POW:ALC AUTO
	ON	Internal level control is permanently switched on. IEC/IEEE-bus command SOUR:POW:ALC ON

ALC OFF MODE	SAMPLE&HOLD	Level recalibration in the ALC OFF mode after the level or frequency has been set. IEC/IEEE-bus command SOUR:POW:ALC:SEAR ON
	TABLE	In the ALC OFF mode correction values are taken from a table. IEC/IEEE-bus command SOUR:POW:ALC:SEAR OFF
SEARCH ONCE ▶		Manual short-time switching on of the level control for level calibration in the ALC OFF and SAMPLE&HOLD operating mode. IEC/IEEE-bus command SOUR:POW:ALC:SEAR ONCE
LEARN TABLE ▶		Correction values for the ALC OFF MODE-TABLE function are regenerated (level control voltage obtained from a table). IEC/IEEE-bus command SOUR:POW:ALC:TABL?

2.5.4 User Correction (UCOR)

Function "User Correction" can be used to create and activate lists in which arbitrary RF frequencies are assigned level correction values.

Up to 10 lists with a total of 160 correction values can be compiled. For frequencies which are not included in the list the level correction is determined by means of interpolation of the nearest correction values.

When user correction is switched on, the LEVEL indication is completed by the indication UCOR (User Correction) in the header field of the display. The RF output level is the sum of both values.

$$\text{LEVEL} + \text{UCOR} = \text{output level}$$

If the offset setting is used at the same time, the LEVEL indication value is the difference of the input values AMPLITUDE and OFFSET of the menu LEVEL.

$$\text{AMPLITUDE} - \text{OFFSET} = \text{LEVEL}$$

The user correction is effective in all operating modes if switched on.

Menu selection: LEVEL - UCOR

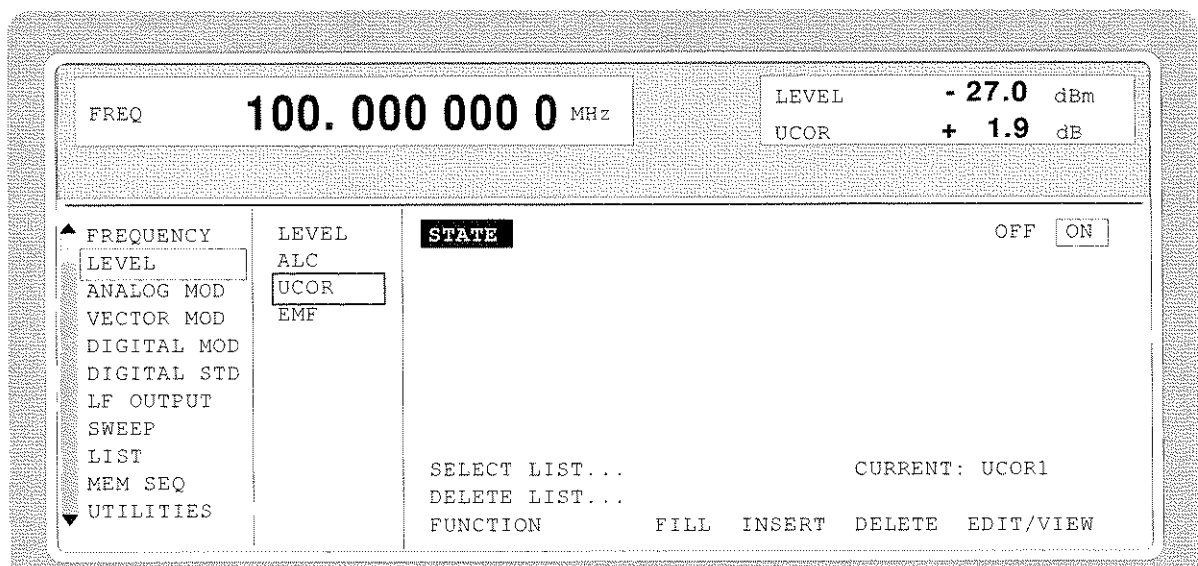

Fig. 2-21 Menu LEVEL - UCOR - OPERATION side

- STATE** Switching on/off user correction.
IEC/IEEE-bus command SOUR:CORR:ON
- SELECT LIST...** Selection of a list or generation of a new list(cf. Section 2.2.4, List Editor)
IEC/IEEE-bus command SOUR:CORR:CSET "UCOR1"
- DELETE LIST...** Deletion of a list (cf. Section 2.2.4, List Editor)
IEC/IEEE-bus command SOUR:CORR:CSET:DEL "UCOR2"
- FUNCTION** Selection of the editing mode to process the selected list
IEC-bus commands SOUR:CORR:CSET:DATA:FREQ 100 MHz, 102 MHz,...
SOUR:CORR:CSET:DATA:POW 1dB, 0.8dB,...

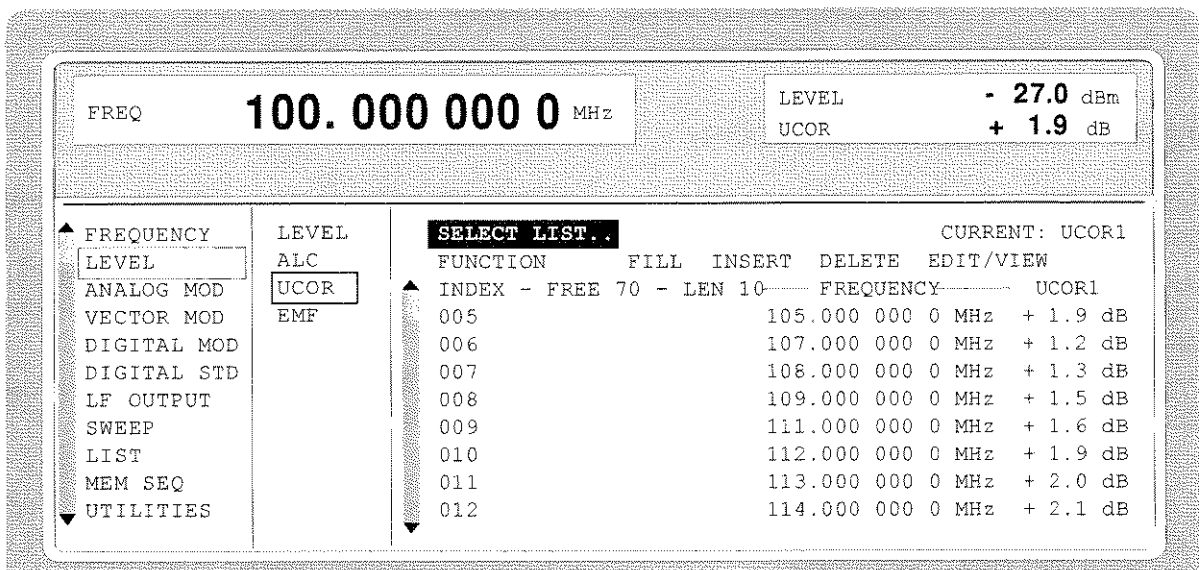

Fig. 2-22 Menu UCOR - LEVEL-EDIT side

2.5.5 EMF

The signal level can also be set and indicated as the voltage of EMF (open-circuit voltage). EMF is displayed in the header field of the display after the unit of the level indication.

Menu selection: LEVEL - EMF

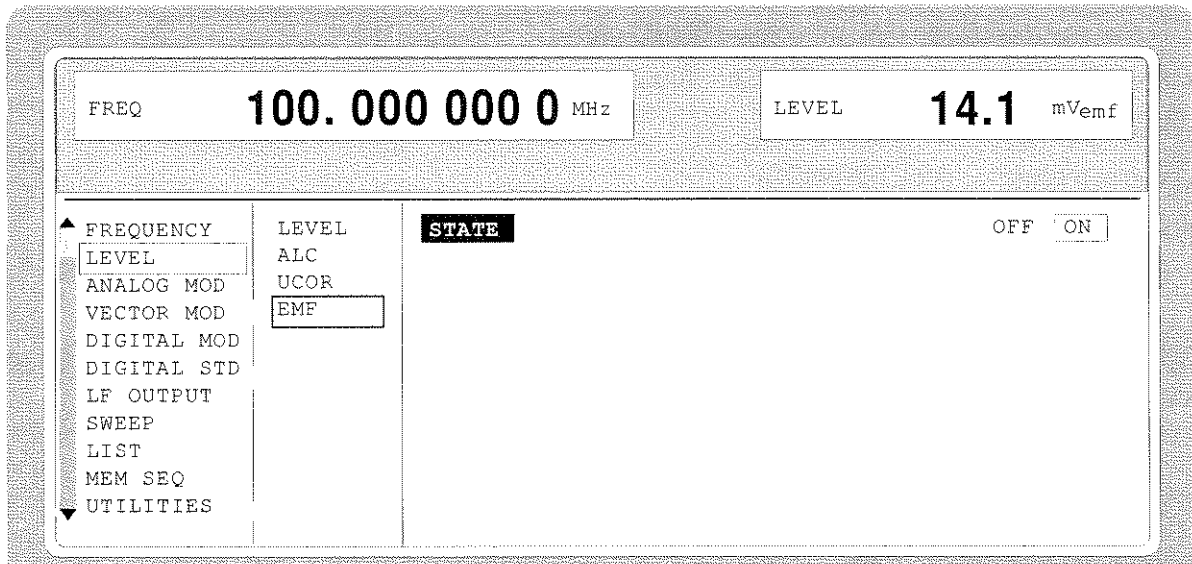

Fig. 2-23 Menu LEVEL-EMF

STATE	ON	Voltage value of the level is the voltage of EMF.
	OFF	Voltage value of the level is voltage at 50 Ω (preset setting).

2.5.6 [RF ON / OFF]-Key

The RF output signal is switched on and off again using the [RF ON / OFF] key. This does not influence the current menu. When the output signal is switched off, the message "RF OFF" is displayed in the LEVEL indication of the header field. If RF OFF is displayed, the 50-Ω source resistance is maintained.

IEC/IEEE-bus command :OUTP OFF

2.5.7 Reset Overload Protection

The SMIQ is protected against overload by an external signal which is fed into the RF output. If an external signal is too high, the overload protection responds. This state is indicated by means of the message "RF OFF" in the LEVEL indication in the header field and the message "OVERLOAD" in the status line.

➤ Reset the overload protection by pressing the [RF ON / OFF] key.

IEC/IEEE-bus command :OUTP:PROT:CLE

2.6 Modulation

The SMIQ offers the following modulations and digital standards:

- Amplitude modulation (AM)
- Broadband AM (BB-AM)
- Frequency modulation (FM; with option SM-B5 only)
- Phase modulation (PM; with option SM-B5 only)
- Pulse modulation (PULSE)
- Vector modulation (VECTOR MOD)
- Digital modulation (DIGITAL MOD; option SMIQB10)
- Digital standards (DIGITAL STD - PHS; IS95/CDMA - option SMIQB32; NADC; PDC; GSM; DECT; options SMIQB10 and SMIQB11)

For AM, FM, PM and digital modulation internal or external modulation sources can be used. For BB-AM, pulse and vector modulation only external modulation sources can be used.

2.6.1 Modulation Sources

Internal Modulation Sources

The internal modulation generator LF GEN is available for AM, FM and PM. The generator supplies sinusoidal signals in the frequency range from 0.1 Hz to 1 MHz. For a more detailed description, cf. Section "LF Generator".

The internal modulation coder (option SMIQB10) supplies PRBS signals, clock signals or modulation data for the digital modulations. The data generator (option SMIQB11) supplies modulation data and control signals. For a more detailed description, cf. Section "Digital Modulations".

External Modulation Sources

The appropriate input sockets to the different modulations in the case of external supply can be taken from table 2-1.

Table 2-1 Input sockets for the different types of modulation

Modulation	Input									
	EXT1	EXT2	PULS (AUX)	I	Q	DATA	PAR DATA	BIT CLOCK	SYMBOL CLOCK	POW RAMP
AM	X									
BB-AM				X						
FM1	X	X								
FM2	X	X								
PM1	X	X								
PM2	X	X								
PULSE			X							
VECTOR MOD				X	X					X
DIGITAL MOD						X	X	X	X	X

The external modulation signal for AM, FM and PM at inputs EXT1 and EXT2 must show a voltage of $V_s = 1\text{ V}$ ($V_{\text{eff}} = 0.707\text{ V}$) in order to maintain the modulation depth or deviation indicated. A monitoring circuit checks the input voltage in the frequency range 10 Hz to 100 kHz. Deviations of more than $\pm 3\%$ are signaled in the status line by means of the following messages (cf. table 2-2). The inputs EXT1 and EXT2 can be AC- or DC-coupled. Monitoring is only active if the inputs are AC-coupled.

Table 2-2 Status messages in the case of a deviation from the rated value at the external modulation inputs EXT1 and EXT2

Message	Deviation
EXT1-HIGH	Voltage at EXT1 too high
EXT1-LOW	Voltage at EXT1 too low
EXT2-HIGH	Voltage at EXT2 too high
EXT2-LOW	Voltage at EXT2 too low
EXT-HI/HI	Voltage at EXT1 and EXT2 too high
EXT-LO/LO	Voltage at EXT1 and EXT2 too low
EXT-HI/LO	Voltage at EXT1 too high and EXT2 too low
EXT-LO/HI	Voltage at EXT1 too low and EXT2 too high

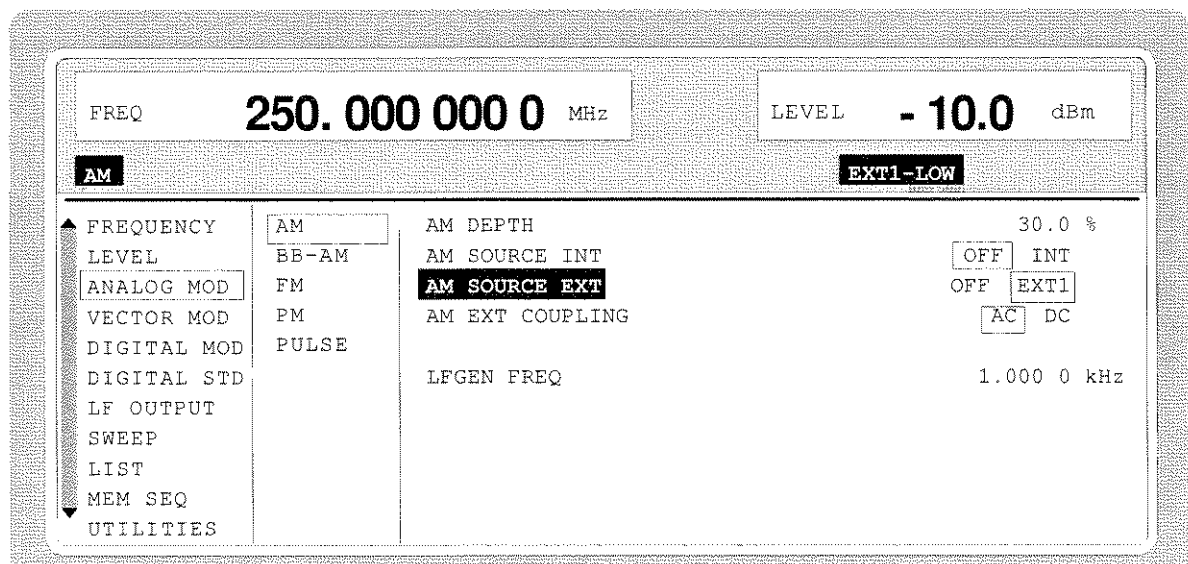

Fig. 2-24 Example: Status message "EXT1-LOW" in case of voltage at EXT1 too low.

I/Q-Inputs

The nominal voltage at the I/Q-inputs for external vector modulation is $U_s = 0.5\text{ V}$. Input resistance is $50\ \Omega$. For a more detailed description, cf. Section "Vector Modulation".

For external broadband AM the I-input is used. Input sensitivity is 0,25V for 100% AM.

2.6.2 Simultaneous Modulation

Combination of AM and FM as well as AM and vector modulation is possible. Instead of FM, phase modulation (PM) can be switched on as well.

Two-tone AM is possible by simultaneously switching on the external and internal source.

Two-tone FM or two-tone PM is possible by simultaneously switching on FM1 and FM2 or PM1 and PM2. For FM1 and FM2 (PM1 and PM2) separate deviations can be set and separate sources switched on.

Note: *With two-tone modulation please observe that the set deviation or modulation depth is valid for one signal and the sum deviation or sum modulation depth is determined by adding both signals. This results in overmodulation if the maximal value for deviation or modulation depth is exceeded.*

2.6.3 [MOD ON/OFF] Key

The modulations can directly be switched on/off using the key or by accessing the modulation menus. When switching on using the [MOD ON/OFF] key, the modulation sources which are set in the modulation menus are used.

The [MOD ON/OFF] key can either be effective for all modulations or for a selected modulation. The selection for which modulation the [MOD ON/OFF] key is effective is made in the UTILITIES-MOD KEY menu (cf. Section "Assigning Modulation to [MOD ON/OFF] Key").

When selecting a certain type of modulation, each pressing the [MOD ON/OFF] key switches on or off the modulation selected.

In the case of selection "all modulations", the [MOD ON/OFF] key has the following effect:

- At least one modulation is active:
Pressing the [MOD ON/OFF] key switches off all active modulations. Which modulations were active is stored.
- No modulation is active:
Pressing the [MOD ON/OFF] key switches on the modulations which were last switched off using the [MOD ON/OFF] key.

2.7 Analog Modulations

2.7.1 LF-Generator

The SMIQ is equipped with a LF- generator as internal modulation source as a standard. The generator supplies sinusoidal signals in the frequency range from 0.1 Hz to kHz.

The frequency settings of the internal modulation signals can be made in one of the modulation menus (AM, FM, PM) as well as in the LF-output menu. Figure 2-25 shows the setting parameters using the the AM menu as an example.

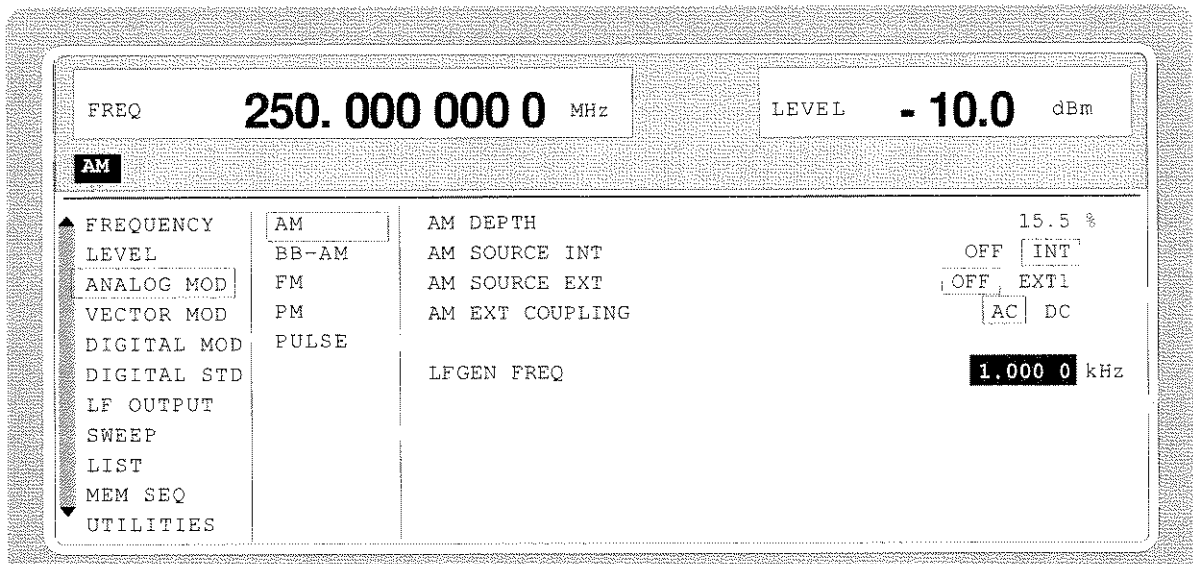

Fig. 2-25 Example: Settings of the LF generator in the AM menu

2.7.2 Amplitude Modulation

Menu ANALOG MOD-AM offers access to settings for amplitude modulation.

- Notes:**
- In the level range from 7 to 13 dBm, the specified AM data are only guaranteed for a linearly decreasing modulation depth with a rising level. When a modulation depth is set that is too high, "WARNING" is displayed in the status line or the message "WARN -221 Settings conflict; modulation forces peak level into overrange" is displayed after pressing the ERROR key.
 - For AM, setting LEVEL-ALC-STATE ON or AUTO is recommended.

Menu selection: ANALOG MOD - AM

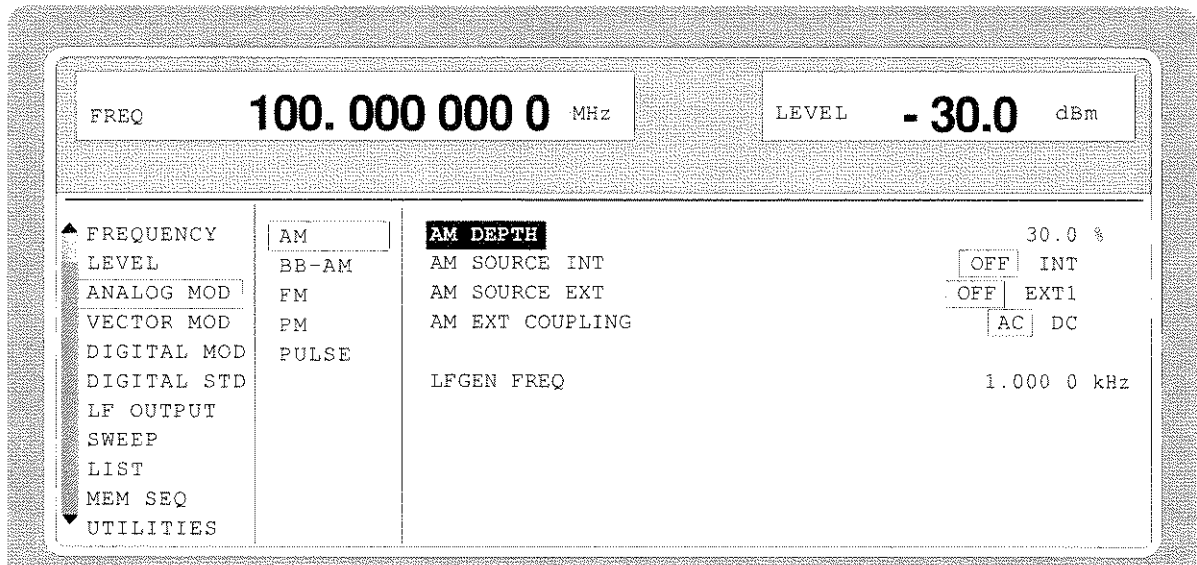

Fig. 2-26 Menu ANALOG MOD-AM (preset setting)

AM DEPTH	Input value of the modulation depth.. IEC/IEEE-bus command SOUR:AM 30PCT
AM SOURCE INT	Selection of the internal source. IEC/IEEE-bus command SOUR:AM:SOUR INT1; STAT ON
AM SOURCE EXT	Selection of the external source. IEC/IEEE-bus command SOUR:AM:SOUR EXT; STAT ON
AM EXT COUPLING	Selection of the kind of coupling AC or DC with external supply (input EXT1). IEC/IEEE-bus command SOUR:AM:EXT:COUP AC
LFGEN FREQ	Input value of the frequency of the LF generator. IEC/IEEE-bus command SOUR:AM:INT:FREQ 1kHz

2.7.3 Broadband AM (BB-AM)

In the BB-AM mode the I/Q modulator is used for amplitude modulation. Level control should be set to AUTO or ON (see section, Switching On/Off Internal Level Control).

The modulation input (BB-AM) is identical with the I input of the I/Q modulator. The input impedance is 50 Ω. A signal of -0.25 V bis +0.25 V corresponds to an amplitude modulation of -100% to +100%. Setting the modulation depth with BB-AM is not possible.

- Notes:**
- Broadband AM is specified up to +7 dBm. When a higher level is set **WARNING** is displayed in the status line.
 - Broadband AM cannot be selected together with normal AM or vector modulation. These modulation deactivate one another

Menu selection: ANALOG MOD - BB-AM

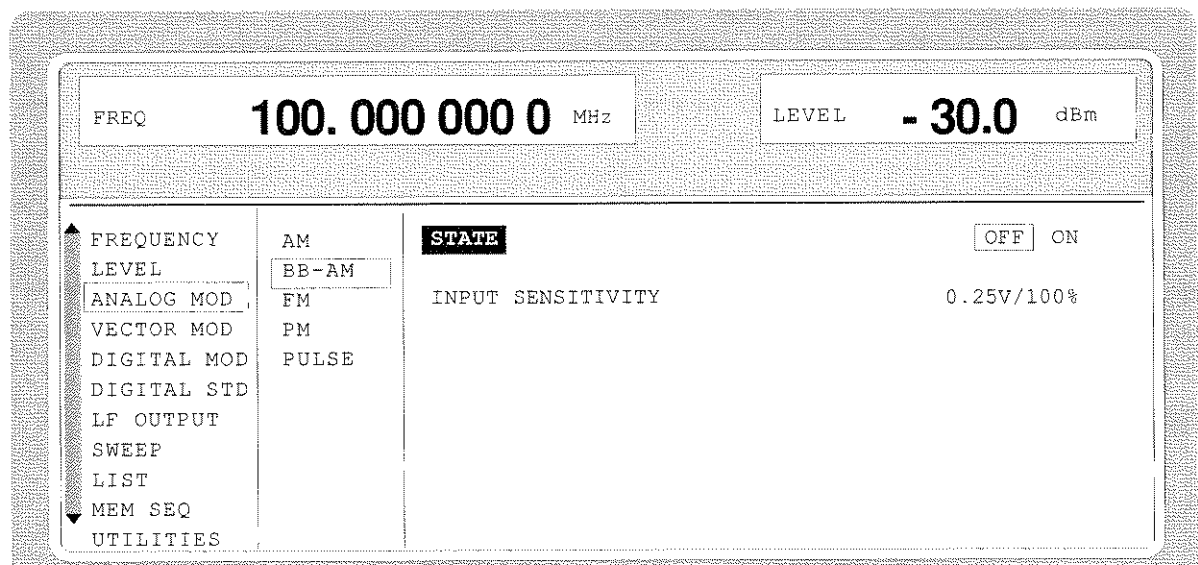

Fig 2-27 Menu ANALOG MOD - BB-AM (preset setting)

STATE Switches BB-AM on and off.
IEC/IEEE-bus command SOUR:AM:BBAN ON

INPUT SENSITIVITY Display of the input sensitivity. The value cannot be changed.

2.7.4 Frequency Modulation

Menu ANALOG MOD-FM offers access to settings for frequency modulation.

Note: The FM and PM modulations cannot be set simultaneously and deactivate one another:

Menu selection: ANALOG MOD-FM

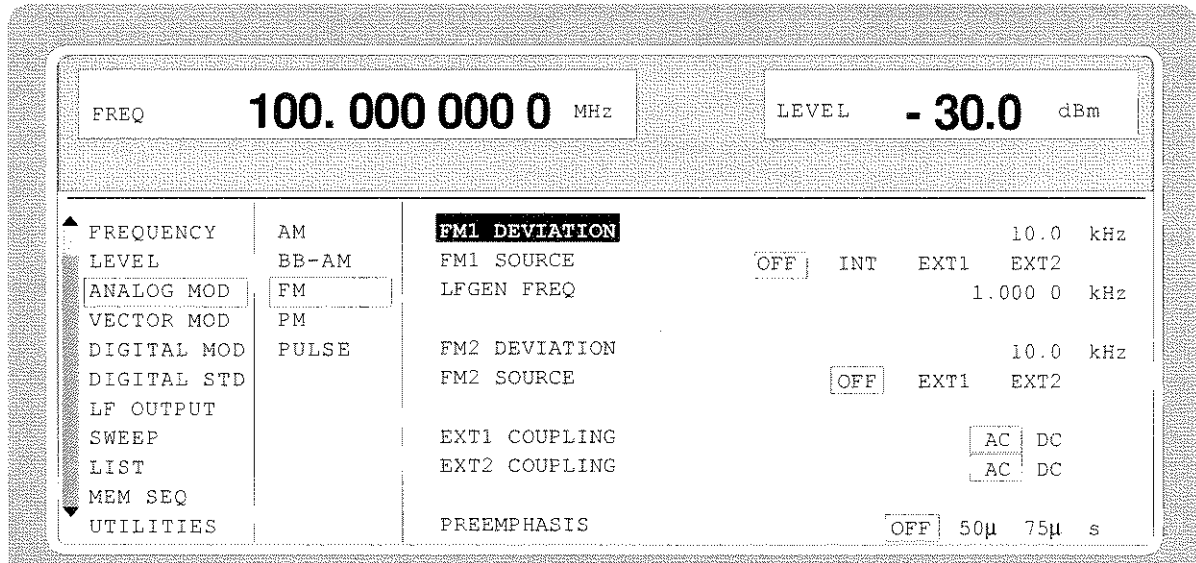

Fig. 2-28 Menu ANALOG MOD-FM (preset setting), fitted with option SM-B5, FM/PM-modulator

- FM1 DEVIATION** Input value of the deviation for FM1.
IEC/IEEE-bus command SOUR:FM1 10kHz
- FM1 SOURCE** Switching on and off FM1 and selection of the modulation source.
IEC/IEEE-bus command SOUR:FM1:SOUR INT; STAT ON
- LFGEN FREQ** Input value of the frequency of the LF generator.
EC-bus short command SOUR:FM1:INT:FREQ 1kHz
- FM2 DEVIATION** Input value of the deviation for FM2.
EC-bus short command SOUR:FM2 10kHz
- FM2 SOURCE** Switching on and off FM2 and selection of the modulation source.
EC-bus short command SOUR:FM2:STAT OFF
- EXT1 COUPLING** Selection of the type of coupling AC or DC for the external input EXT1.
IEC/IEEE-bus command SOUR:FM1:EXT1:COUP AC
- EXT2 COUPLING** Selection of the type of coupling AC or DC for the external input EXT2.
IEC/IEEE-bus command SOUR:FM1:EXT2:COUP AC
- PREEMPHASIS** Selection of the preemphasis
IEC-bus short command SOUR:FM1:PRE 50us

2.7.4.1 FM Deviation Limits

The maximal deviation depends on the RF frequency set (cf. Fig. 2-29). It is possible to enter a deviation that is too high for a certain RF frequency or to vary the RF frequency to a range in which the deviation can no longer be set. In this case the maximally possible deviation is set and an error message is displayed.

In the RF range 450 MHz to 750 MHz and 1200 MHz to 1500 MHz a different synthesis range is selected depending on the deviation set. If the deviation is smaller than 500 kHz or 1000 kHz, the synthesizer is in the normal mode with optimal spectral purity. If the deviation set is larger the I/Q mode is automatically selected.

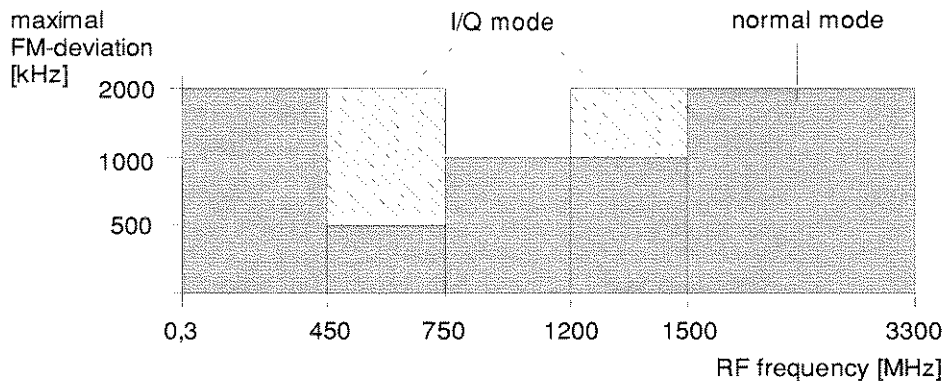

Fig. 2-29 Dependency of the FM maximal deviation on the RF frequency set

2.7.4.2 Preemphasis

Preemphasis results in a preemphasis of the modulation signal with time constants 50 μ s or 75 μ s. The higher frequencies of the modulation signal are preemphasized.

When preemphasis is switched on, only 1/4 of the maximal deviation is permissible. The highest permissible modulation frequency is 15 kHz. Exceeding the permissible modulation frequency can lead to overmodulation.

2.7.5 Phase Modulation

Menu ANALOG MOD-PM offers access to settings for phase modulation.

Note: The PM and FM modulations cannot be set simultaneously and deactivate one another.

Menu selection: ANALOG MOD - PM

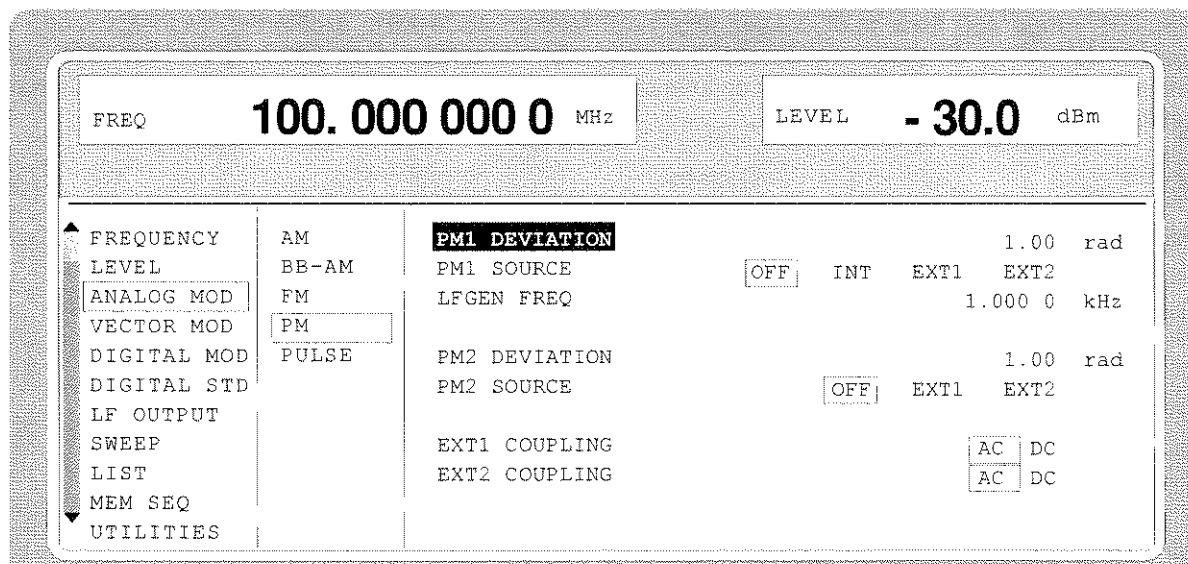

Fig. 2-30 Menu ANALOG MOD - PM (preset setting), fitted with option SM-B5, FM/PM-modulator

- PM1 DEVIATION** Input value of the deviation for PM1.
IEC/IEEE-bus command SOUR:PM1 1RAD

- PM1 SOURCE** Switching on and off PM1 and selection of the modulation source.
IEC/IEEE-bus command SOUR:PM1:SOUR:INT; STAT ON

- LFGEN1 FREQ** Input value of the frequency of the LF generator.
IEC/IEEE-bus command SOUR:PM1:INT:FREQ 1kHz

- PM2 DEVIATION** Input value of the deviation for PM2.
IEC/IEEE-bus command SOUR:PM2 1RAD

- PM2 SOURCE** Switching on and off PM2 and selection of the modulation source.
IEC/IEEE-bus command SOUR:PM2:SOUR INT; STAT ON

- EXT1 COUPLING** Selection of the type of coupling AC or DC with external supply for PM1 (input EXT1).
IEC/IEEE-bus command SOUR:PM:EXT1:COUP AC

- EXT2 COUPLING** Selection of the type of coupling AC or DC with external supply for PM2 (input EXT2).
IEC/IEEE-bus command SOUR:PM:EXT2:COUP AC

2.7.5.1 PM Deviation Limits

The maximal deviation depends on the RF frequency set (cf. Fig. 2-31). It is possible to enter a deviation that is too high for a certain RF frequency or to vary the RF frequency to a range in which the deviation can no longer be set. In this case the maximally possible deviation is set and an error message displayed.

In the RF range 450 to 750 MHz and 1200 MHz to 1500 MHz a different synthesis range is selected depending on the deviation set. If the deviation is smaller than 5 rad or 10 rad, the synthesizer is in the normal mode with optimal spectral purity. If the deviation set is larger, the I/Q mode is automatically selected.

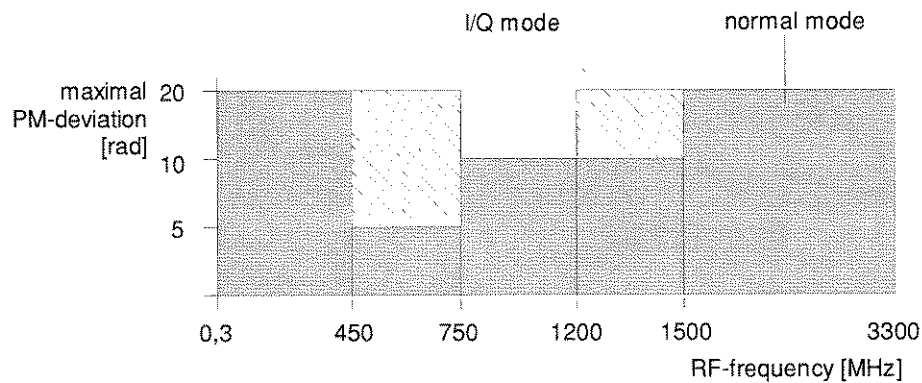

Fig. 2-31 Dependency of the PM maximal deviation on the RF frequency set

2.7.6 Pulse Modulation

The pulse modulator can be controlled by an external source at the PULSE input (AUX IN/OUT at the rear of the instrument).

The polarity of the pulse modulation is selectable. With POLARITY = NORM, the RF level is on with HIGH level at modulation input PULSE.

Menu MODULATION-PULSE offers access to settings for pulse modulation

Menu selection: MODULATION - PULSE

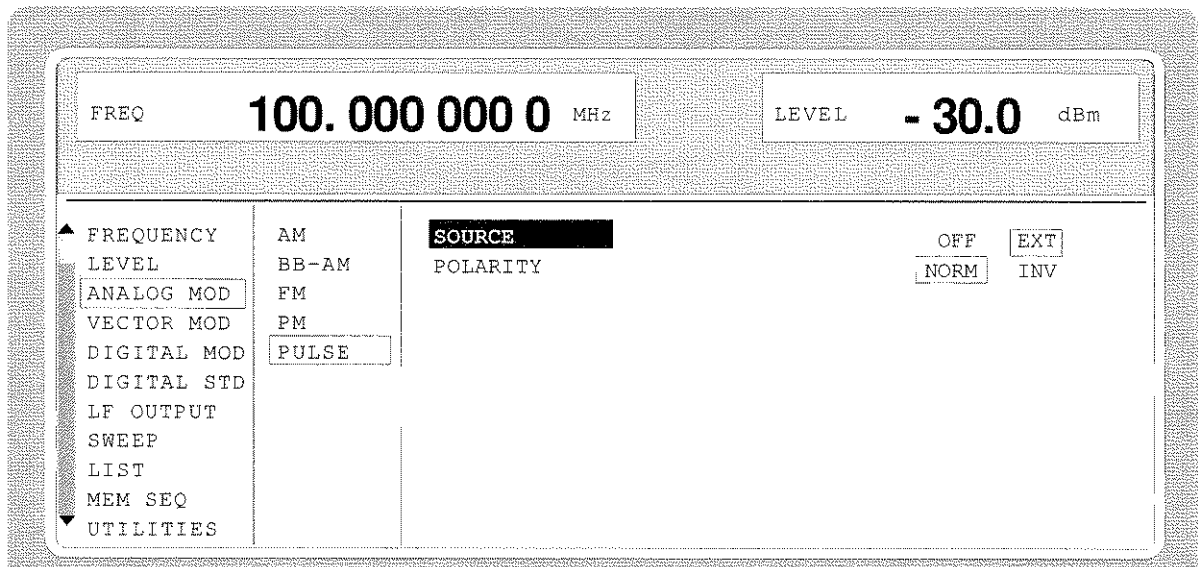

Fig. 2-32 Menu MODULATION-PULSE (preset setting), fitted with option SM-B3, pulse modulator, and option SM-B4, pulse generator.

SOURCE Selection of the modulation source.
IEC/IEEE-bus command :PULM:SOUR INT; STAT ON

POLARITY Selection of the polarity of the modulation
NORM The RF signal is on during high level.
INV The RF signal is suppressed during high level.
IEC/IEEE-bus command :PULM:POL NORM

2.8 Vector Modulation

In the vector modulation mode (I/Q modulation) external modulation signals can be applied to modulation inputs I and Q for a complex modulation of the RF carrier.

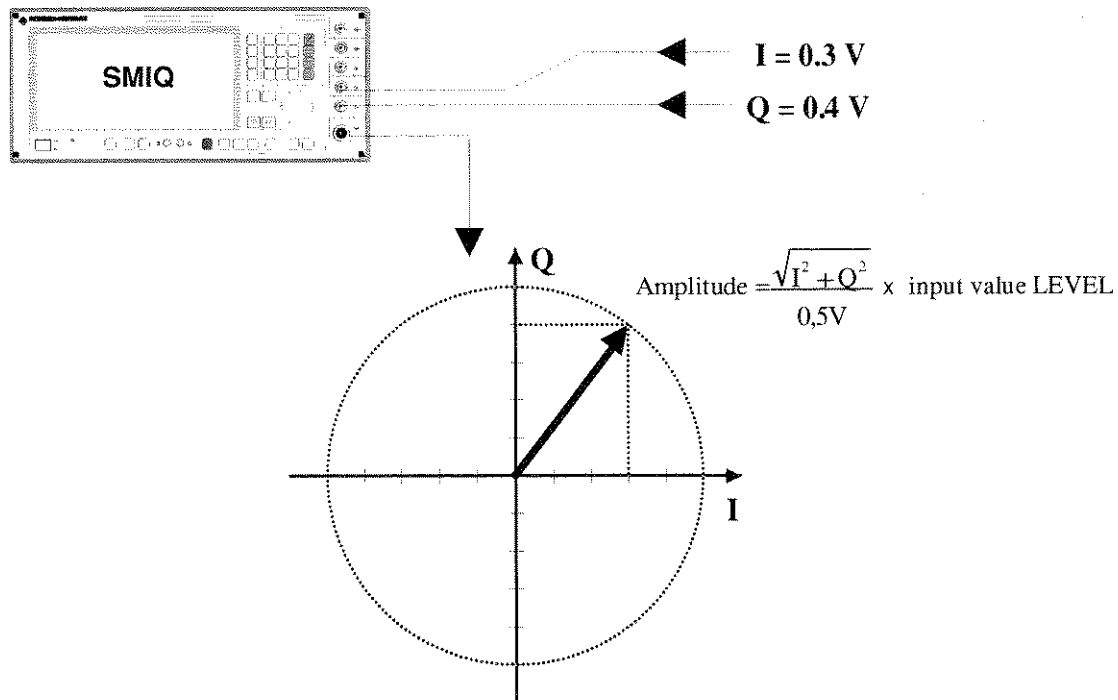

Fig. 2-33 Example: vector modulation

If the I/Q modulator is driven by a constant sum vector modulation of $\sqrt{I^2 + Q^2} = 0.5V$ the actual RF level corresponds to the displayed RF level. To avoid the I/Q modulator being overdriven, care should be taken that the sum vector never exceeds 0.5 V when digital modulation modes with amplitude modulation components such as QPSK are used. For full-scale input, the peak envelope power of the modulated RF signal is thus equal to the indicated LEVEL. The average power is smaller. The difference can be entered as an offset in the LEVEL menu.

Vector modulation settings are accessible in the VECTOR MOD menu.

- Note:**
- Types of modulation VECTOR MOD and BB-AM cannot be set at the same time; they switch each other off.
 - A selectable internal calibration of the I/Q modulator allows accurate and reproducible measurements to be made. The calibration routine should be called up with the CALIBRATE ► in the menu VECTOR MOD or UTILITIES-CALIB-VECTOR MOD after temperature changes of more than 5° C.

Select: VECTOR MOD menu

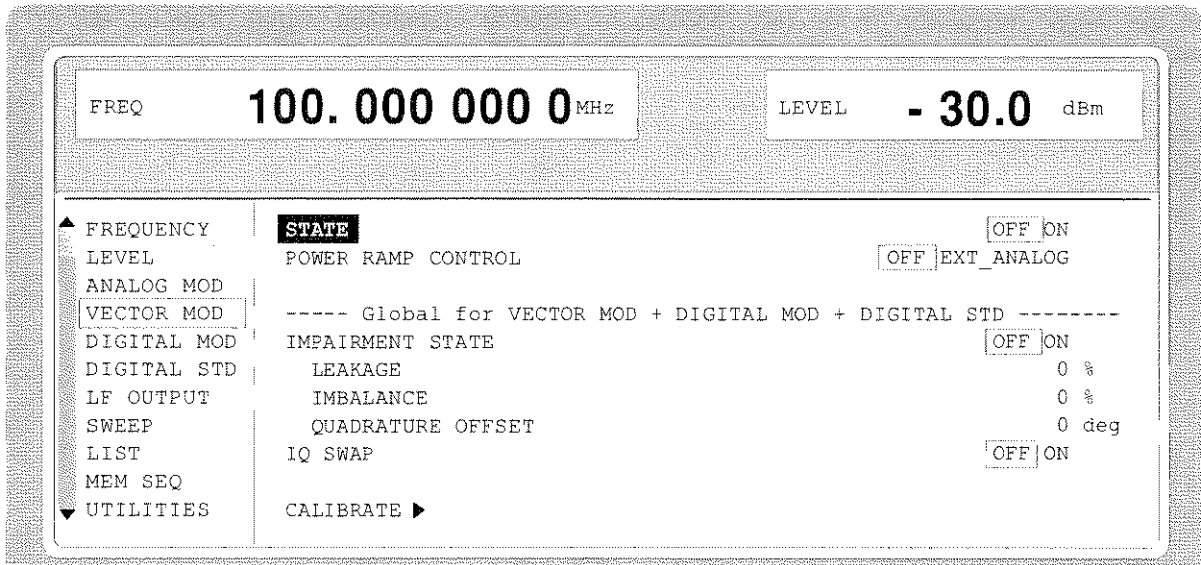

Fig. 2-34 VECTOR MOD menu (preset settings)

- STATE** Switches the vector modulation on and off.
IEC/IEEE-bus command SOUR:DM:IQ:STAT ON
- POWER RAMP CONTROL** Switches the POW RAMP input for analog level control on and off. Thus an external control signal can be used for carrier envelope modulation in parallel to vector modulation..
IEC/IEEE-bus command SOUR:DM:IQ:PRAM AEXT
- IMPAIRMENT STATE** Switches I/Q impairment on and off.
IEC/IEEE-bus command SOUR:DM:IQ:IMP:STAT ON
- LEAKAGE** Value entered for residual carrier .
IEC/IEEE-bus command SOUR:DM:LEAK 10PCT
- IMBALANCE** Value entered for imbalanced modulation of I and Q vectors.
IEC/IEEE-bus command SOUR:DM:IQR -5PCT
- QUADRATURE OFFSET** Value entered for quadrature offset .
IEC/IEEE-bus command SOUR:DM:QUAD:ANGL 4DEG
- IQ SWAP** Selection between normal and inverted I/Q modulation. Interchanging the I and Q signals inverts the modulation sidebands.
OFF Normal I/Q modulation.
ON I and Q signals interchanged.
IEC/IEEE-bus command SOUR:DM:IQSW:STAT ON
- CALIBRATE ►** Triggers a calibration for the I/Q modulator
IEC/IEEE-bus command :CAL:VMOD?

2.8.1 I/Q Impairment

For simulating an impairment of the vector modulation, a residual carrier (LEAKAGE), imbalanced I and Q modulation (IMBALANCE) and a quadrature offset can be entered. The input values for LEAKAGE and IMBALANCE are with reference to the voltage.

Table 2-3 Parameter setting ranges

Parameter	Setting range	Resolution
LEAKAGE	0 ... 50 %	0.5 %
IMBALANCE	-12 ... +12 %	0.1 %
QUADRATURE OFFSET	-10 ... +10°	0.1°

The following figure shows the effect of I/Q impairment.

LEAKAGE:

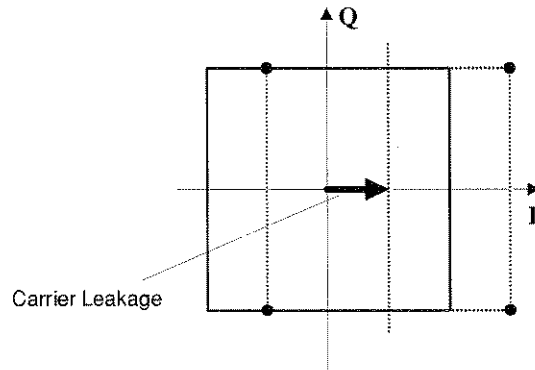

IMBALANCE:

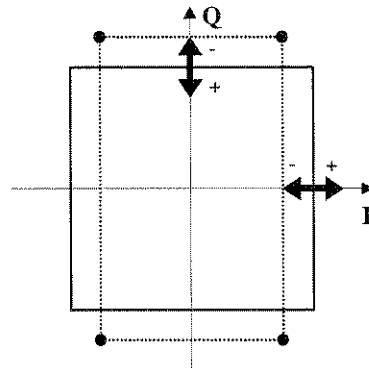

QUADRATURE OFFSET:

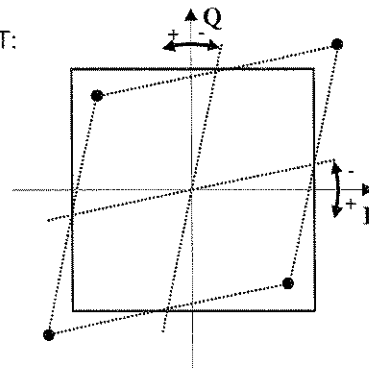

Fig. 2-35 Effect of I/Q impairment

2.9 Fading Simulation

By means of the option Fading Simulator SMIQB14, multipath fading signals with 6 independent transmission paths can be generated.

Important: The Fading Simulator can only be operated with the complex baseband signals I and Q. Therefore, it is necessary to switch on either Vector Modulation or Digital Modulation.

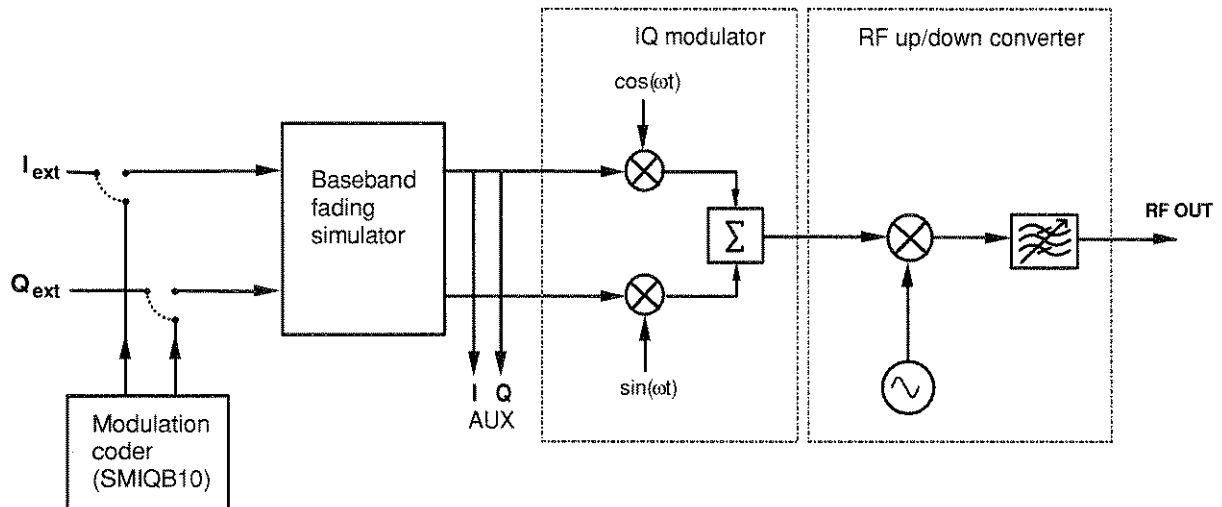

Fig. 2-36 Fading simulator in the SMIQ

The input signals for the fading simulator can either be applied to the modulation inputs I and Q or will be generated in the SMIQ by the optional Modulation Coder (SMIQB10). The output signals of the fading simulator will be passed to the IQ Modulator and then be mixed to the RF.

SMIQ can also be equipped with two Fading Simulators (SMIQB14 and SMIQB15). The second fading option provides another 6 transmission paths.

If only one fading simulator is built in, output signals I and Q are available at the AUX connector.

If two fading simulators are built in, the sum signal of the two fading options with 12 fading paths are available at the AUX connector.

Note: A selectable internal calibration of the fading simulator allows internal compensation of DC offset voltages. The calibration routine should be called up after temperature changes of more than 5 degree in menu UTILITIES-CALIB-FSIM.

2.9.1 Output Power with Fading

If one single path is switched on with PATH LOSS set to 0 dB, the fading simulator has a 12 dB to 18 dB insertion loss on the IQ signals applied. This insertion loss will be corrected automatically in the SMIQ. This means: If the fading simulator is switched on with only one path at 0 dB, the average power at the RF output of the SMIQ is the same as with the fading switched off. If further paths will be switched on, the output signals of all paths will be interfered. The average RF-output power will then be different from the RF-level displayed.

The total average power at the RF output is however displayed under TOTAL POWER in the FADING SIM menu.

Due to the insertion loss of the fading simulator the maximum available output power of the SMIQ is reduced by up to 18 dB.

2.9.2 Two-Channel Fading

A SMIQ with two fading options (SMIQB14 and SMIQB15) as well as a second SMIQ without fading options is required for two-channel fading. The cables in SMIQ have to be replugged as described in chapter 1, section "Second Fading Simulator". After this modification, the I/Q baseband signals of the 2nd channel (SMIQB15) are available at the AUX connector (rear of unit). They can be connected to the IQ inputs of the second SMIQ with the two connection cables (Part No. 1085.4448.00) supplied with the option SMIQB14. Vector modulation has to be switched on at the second SMIQ.

Note: Due to the 18 dB insertion loss of the fading simulator the RF2 level is 18 dB below the displayed RF level (INSERTION LOSS SETTING MODE = NORMAL). This can be corrected by entering an offset in the LEVEL menu.

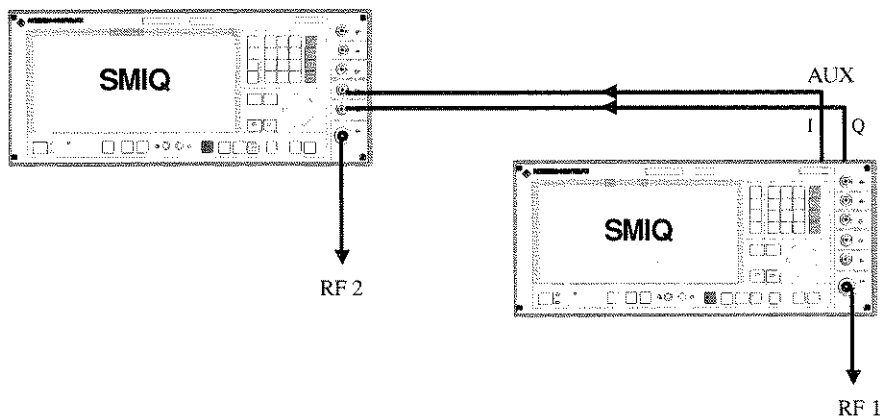

Fig. 2-37 Two-channel fading

2.9.3 Correlation between Paths

Fading processes of different paths normally do not depend on statistical processes. However, it is possible to set a correlation of paths 1 to 6 with paths 7 to 12 in pairs. To set the correlation, a synchronous signal processing is required for the two fading options which involves the following restrictions:

- The correlation is always reciprocal, ie if path 1 is correlated with path 7, path 7 is also correlated with path 1 (CORR PATH).
- The following parameters of the two paths have to correspond:
 - Fading profile PROFILE
 - Doppler parameter SPEED or DOPPLER FREQ
 - Magnitude of correlation coefficient COEFF
- The following equation applies to the phase of the correlation coefficient and thus to the phase shift between the correlated paths:

$$\varphi_{12} = 360^\circ - \varphi_{21}$$

- The parameters for Log Normal fading have to correspond for correlated paths.

All parameter adaptations due to the limitations mentioned before are automatically performed by SMIQ.

Note: *After setting all parameters, the two fading options have to be synchronized by RESET and then by RUN.*

2.9.4 Fading Simulation Menu

Fading simulation settings are accessible in the FADING SIM menu.

Menu selection: FADING SIM

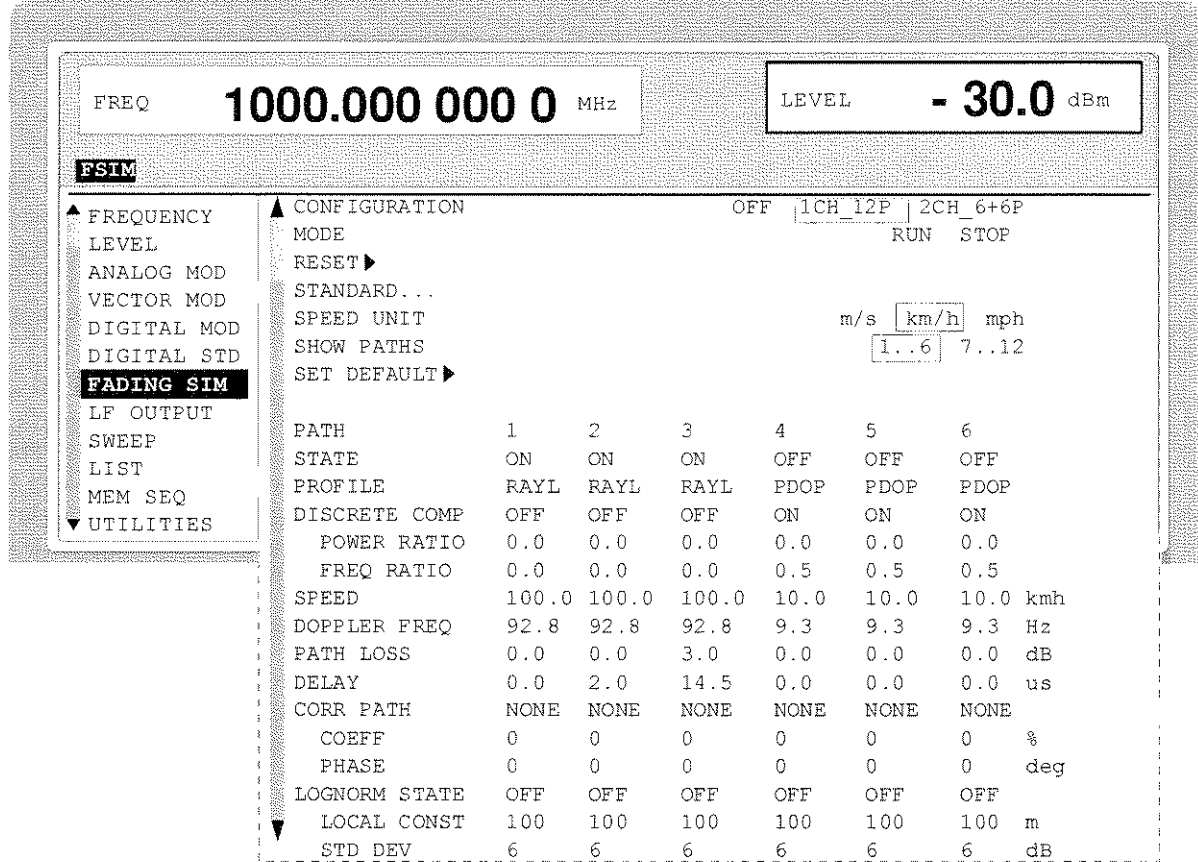

Fig. 2-38 Menu FADING SIM (two fading simulators installed)

CONFIGURATION Switching on fading simulation by selection of the number of active paths and channels.

1CH_6P One channel with 6 paths (with option SMIQB14)

1CH_12P One channel with 12 paths (with SMIQB14 and SMIQB15)

2CH_6+6 Two channels with 6 paths each (with SMIQB14 and SMIQB15)

IEC\IEEE-bus command SOUR:FSIM:CONF S12P
SOUR:FSIM ON

MODE Stopping (STOP) and starting (RUN) the fading process.
Following RESET the mode RUN starts the Pseudo Noise Generator at a defined starting point for generating the fading process.

IEC\IEEE-bus command SOUR:FSIM:SEQ RUN

RESET Resetting the Pseudo Noise Generator.
If RESET is set, the parameter MODE is automatically set to STOP. RESET also ensures a synchronization of the two fading options during 2-channel mode with the correlation switched on.

IEC\IEEE-bus command SOUR:FSIM:SEQ:RES

STANDARD	<p>Opens a window for selecting a standard setting of the fading paths. The parameter settings comply with the measurement specifications of mobile communication standards (e.g. GSM, CDMA, NADC).</p> <p>IEC/IEEE-bus command SOUR:FSIM:STAN CDMA100</p>
SPEED UNIT	<p>Selection of the speed unit.</p> <p>IEC/IEEE-bus command SOUR:FSIM:SPE:UNIT KMPH</p>
INSERTION LOSS SETTING MODE	<p>Selection of setting mode for the insertion loss of the fading simulator.</p> <p>NORMAL The minimum insertion loss for a path of the fading simulator is fixed to 18 dB. The value has been chosen so that even with Log Normal-Fading switched on, the fading simulator will seldom be overdriven. This setting should be chosen for BER measurements.</p> <p>IEC/IEEE-bus command :SOUR:FSIM:ILOS:MODE NORM</p> <p>LOW_ACP The minimum insertion loss is between 12 and 14 dB. The value depends on the PATH LOSS setting of the selected paths. This mode is ideal for all STANDARD menu settings regarding signal/noise ratio and residual carrier suppression. This setting should be chosen for measurements which involve an adjacent-channel interfering signal generated by the SMIQ.</p> <p>IEC/IEEE-bus command :SOUR:FSIM:ILOS:MODE LACP</p>
TOTAL POWER	<p>Indication of total average power at RF output. The total power is the sum of the power of the individual paths. If only one path with 0 dB PATH LOSS has been selected, the total power is equal to the RF level (LEVEL) indicated on the display.</p> <p>IEC/IEEE-bus command :SOUR:FSIM:POW?</p>
SHOW PATHS	<p>Switching from the display of paths 1 to 6 to the display of paths 7 to 12.</p>
SET DEFAULT ►	<p>Default setting of path parameter with path 1 switched on and all other paths switched off.</p> <p>IEC/IEEE-bus command SOUR:FSIM:DEF</p>
PATH	<p>The following parameter have to be set separately for each path.</p>
STATE	<p>Switching on and off a path.</p> <p>Note: <i>If the cursor is placed onto a path in the diagram, it may be switched on and off by pressing one of the unit keys (toggle function).</i></p> <p>IEC/IEEE-bus command SOUR:FSIM:PATH3:STAT ON</p>
PROFILE	<p>Selection of the fading profile.</p> <p>PDOP (Pure DOPpler) Simulation of a transmission path having a single direct connection from the transmitter to the moving receiver (discrete component). The Doppler Frequency shift is determined by the parameters DOPPLER FREQ and FREQ RATIO.</p> <p>IEC/IEEE-bus command SOUR:FSIM:PATH4:PROF PDOP</p>

- (PROFILE)**
- RAYL** (RAYLeigh) Simulation of a radio field, where a multitude of broadly scattered partial waves hit upon a moving receiver. The receiving amplitude resulting therefrom is time-varying. The probability density function of the receiving amplitude is described by a Rayleigh distribution. The fading spectrum is a classical Doppler spectrum.
IEC\IEEE-bus command SOUR:FSIM:PATH1:PROF RAYL
 - RICE** Simulation of a radio field, where apart from a multitude of scattered partial waves, one strong direct wave (discrete component) hits upon a moving receiver. The probability density function of the receiving amplitude is described by a Rice distribution. The fading spectrum of an unmodulated signal is an overlapping of a classical Doppler spectrum with a discrete spectrum line.
IEC\IEEE-bus command SOUR:FSIM:PATH7:PROF RICE

DISCRETE COMP Shows the status of the discrete component (ON or OFF).
IEC\IEEE-bus command SOUR:FSIM:PATH4:DCOM:STAT ON

POWER RATIO Input value of the power ratio of the discrete component and distributed component with Ricean fading switched on. If POWER RATIO is changed the sum of both components remains constant.
IEC\IEEE-bus command SOUR:FSIM:PATH6:PRAT 3

FREQ RATIO Input value of the ratio of the actual Doppler Frequency shift to the Doppler Frequency setting with Ricean fading or Pure Doppler switched on. The actual Doppler Frequency shift depends on the simulated angle of incidence of the discrete component.
IEC\IEEE-bus command SOUR:FSIM:PATH6:FRAT 1

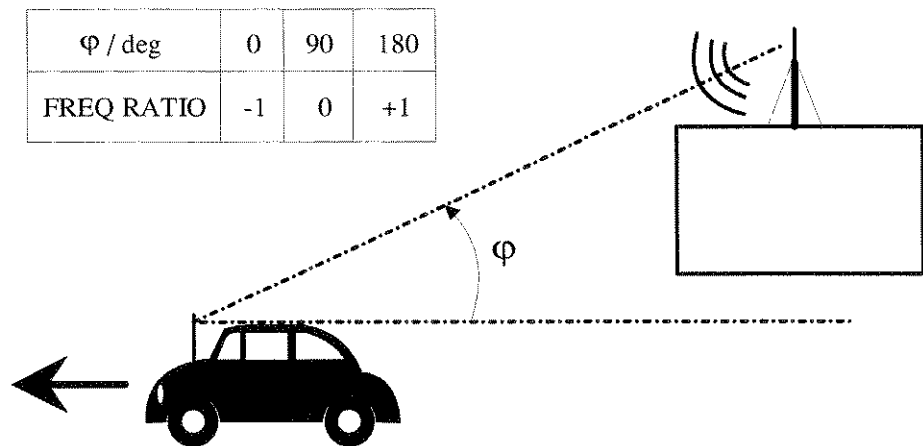

Fig. 2-39 Doppler Frequency shift with moving receiver

SPEED

Input value of the speed v of the moving receiver.
The Doppler frequency f_D (DOPPLER FREQ) is calculated from the speed and the RF frequency f_{RF} . When changing SPEED the parameter DOPPLER FREQ will be automatically adjusted.

$$\text{Range: } v_{\min} = \frac{0.03 \cdot 10^9 \text{ m/s}^2}{f_{RF}} \quad v_{\max} = \frac{479 \cdot 10^9 \text{ m/s}^2}{f_{RF}}$$

$$v_{\max} \leq 99999 \text{ km/h}$$

IEC\IEEE-bus command SOUR:FSIM:PATH1:SPE 100

DOPPLER FREQ

Input value of the amount of the maximum Doppler Frequency shift (cf. FREQ RATIO).
When changing the Doppler Frequency f_D the parameter SPEED will be automatically adjusted.

With $c = 2.998 \cdot 10^8 \text{ m/s}$ it is $\frac{v}{c} = \frac{f_D}{f_{RF}}$

IEC\IEEE-bus command SOUR:FSIM:PATH2:FDOP 92.3

PATH LOSS

Input value of the attenuation of the path.

IEC\IEEE-bus command SOUR:FSIM:PATH3:LOSS 3

DELAY

Input value of the signal delay in the path.

IEC\IEEE-bus command SOUR:FSIM:PATH3:DEL 14.5

CORR PATH

Switching on or off (NONE) a correlation with the selected path. This setting is accessible if both fading options SMIQB14 and SMIQB15 have been installed. Only a two by two correlation of paths 1 to 6 with paths 7 to 12 can be set.

IEC\IEEE-bus command SOUR:FSIM:PATH6:CORR:PATH 12

COEFF

Input value of the amplitude of the complex correlation coefficient.

IEC\IEEE-bus command SOUR:FSIM:PATH6:CORR:COEF 0.5

PHASE

Input value of the phase of the complex correlation coefficient.

IEC\IEEE-bus command SOUR:FSIM:PATH6:CORR:PHAS 180

LOGNORM STATE

Switching on or off the Log Normal-Fading.

With Log Normal-Fading set, an additional rather slow continuous changing of the receiving amplitude of a moving receiver is simulated. Log Normal-Fading has a multiplying effect on the path loss. The multiplication factor is time-varying and logarithmically normally distributed. If a Rayleigh profile is set simultaneously, this results in Suzuki-Fading.

IEC\IEEE-bus command SOUR:FSIM:PATH6:LOGN:STAT ON

LOCAL CONST Input value of the area constant L.

The area constant L and the speed v of the moving receiver determine the corner frequency f_L of Log Normal-Fading:

$$f_L = v / L$$

The power density spectrum of an unmodulated carrier (CW) is an overlapping of a discrete spectrum line at f_{RF} with a frequency dependent continuous spectrum described by

$$S(f) = \text{const} \cdot e^{-0.5 \cdot \left(\frac{f - f_{RF}}{f_L} \right)^2}$$

The lower limit of the range is dependent on the RF frequency f_{RF} :

$$L_{\min} = \frac{12 \cdot 10^9 \text{ m/s}}{f_{RF}}$$

IEC\IEEE-bus command SOUR:FSIM:PATH6:LOGN:LCON 150

STD DEV

Input value of the standard deviation of the Log Normal-Fading.

IEC\IEEE-bus command SOUR:FSIM:PATH6:LOGN:CSTD 6

2.10 Digital Modulation

With option Modulation Coder (MCOD) SMIQB10 provided, SMIQ can generate digitally modulated output signals. Available modulation methods are FSK (frequency shift keying), PSK (phase shift keying) as well as QAM (quadrature amplitude modulation) . Baseband filtering and symbol rate can be freely set in a wide range.

The modulation coder generates the analog IQ signals for the I/Q modulator of SMIQ from the digital input signals.

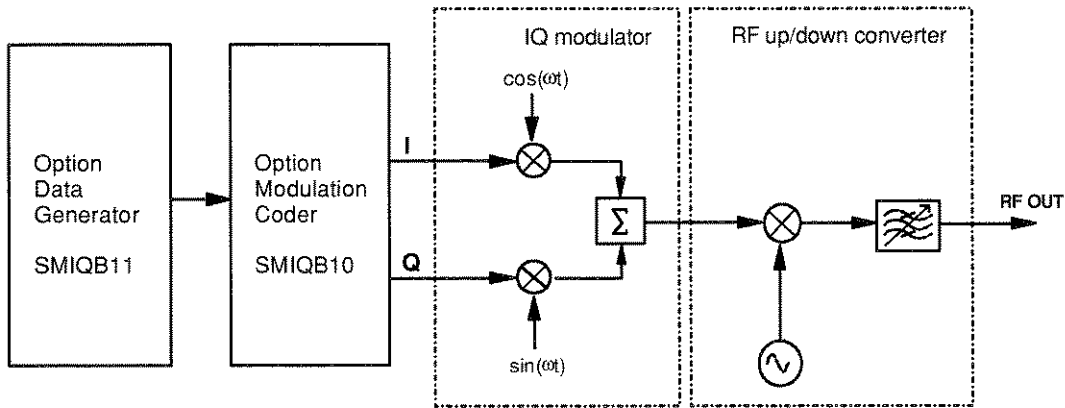

Fig. 2-40 Modulation coder in SMIQ

The modulation coder works with digital input signals such as

- clock signals (symbol clock, bit clock),
- modulation data or modulation symbols,
- control signals for envelope control and trigger signals.

The digital input signals may originate from the following sources:

- The modulation coder can generate clock signals such as PRBS data signals and simple data patterns.
- External clock signals, modulation data and signals for envelope control can be fed in via connectors at the front or rear panel of SMIQ.
- With option Data Generator SMIQB11 provided, an additional data source is available. This option has a 4-Mbit memory for modulation data and control signals. The memory can be extended to 12 Mbit or 20 Mbit by installing one or two SMIQB12 options (Memory Extension).

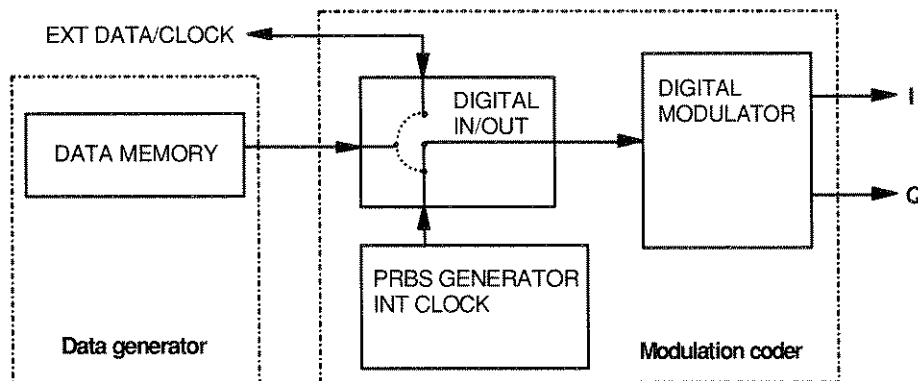

Fig. 2-41 Digital input signals of modulation coder

2.10.1 Digital Modulation Methods and Coding

The input sequence of modulation symbols d_n can be subject to different types of coding. I and Q values are assigned to the coded modulation symbols dc_n in the functional block MAPPING.

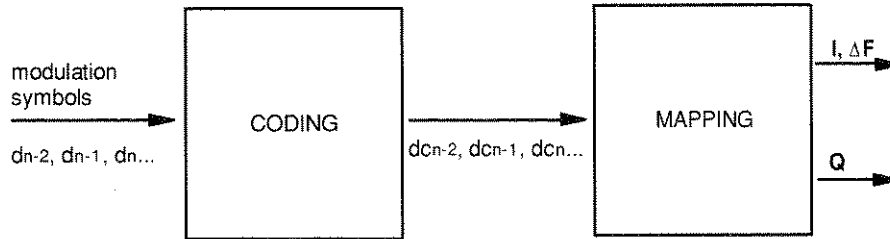

Figure 2-42 Functional blocks Coding and Mapping

2.10.1.1 PSK and QAM Modulation

PSK and QAM modulations can be explained on the basis of a rule of assignment (mapping) according to which each modulation symbol is represented by I and Q values as shown in the following IQ constellation diagrams. The constellation diagrams apply if **no** coding is switched on.

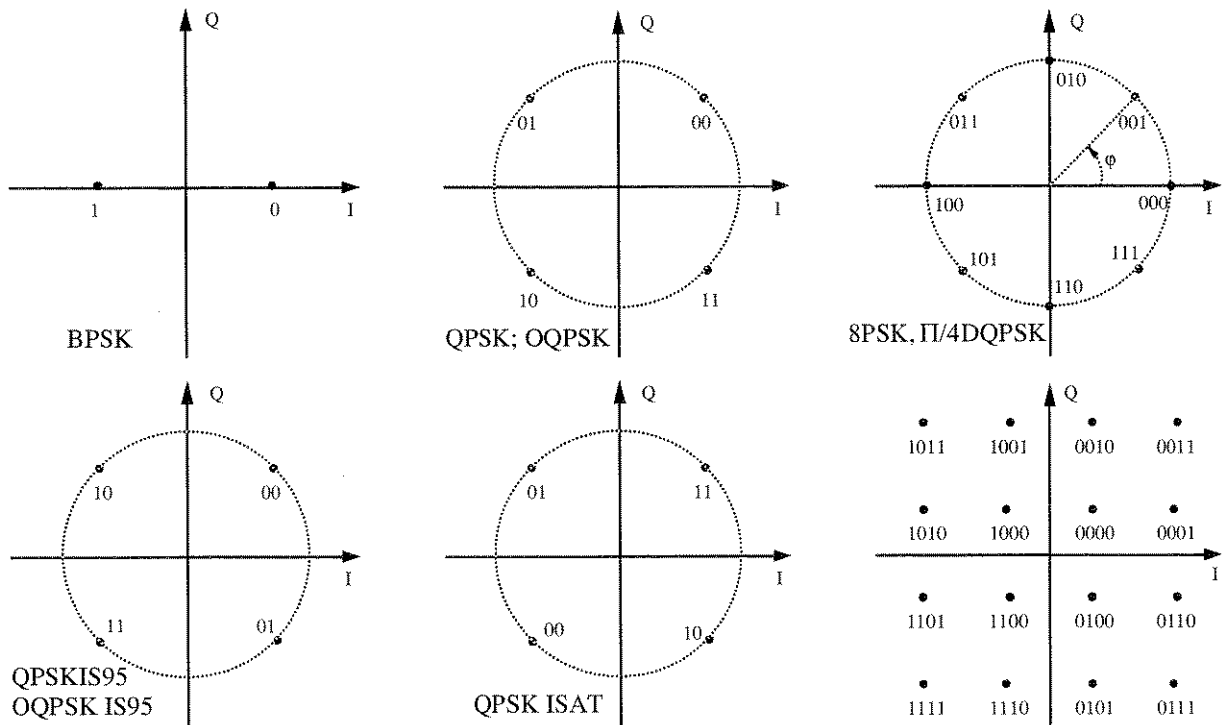

Fig. 2-43 Constellation diagrams of BPSK, QPSK, 8PSK and 16QAM

For offset QPSK (OQPSK), the Q signal is delayed by half the symbol period with reference to the I signal.

QAM modulation methods 16QAM, 32QAM, 64QAM and 256QAM were implemented according to ETSI standard ETS 300429 for Digital Video Broadcasting (DVB).

All PSK and QAM modulation methods can be combined with COS and SQR_COS baseband filters as well as with IS-95 filters. A combination with GAUSS and BESSEL filters is not possible.

2.10.1.2 Modulation $\pi/4$ DQPSK

With differential coding switched on at the same time, a constellation diagram is obtained for $\pi/4$ DQPSK which is similar to that obtained for 8PSK. Phase shifts are however assigned to the individual modulation symbols. The following tables show the assignment of modulation symbols to phase shifts of IQ vectors at the selected coding.

Table 2-4 Phase shifts for $\pi/4$ DQPSK without coding

Modulation symbol d_n (binary indication: MSB, LSB)	00	01	10	11
Phase shift φ	+ 45°	+135°	-135°	-45°

Table 2-5 Phase shifts for $\pi/4$ DQPSK with coding NADC, PDC, PHS, TETRA or APCO25

Modulation symbol d_n (binary display: MSB, LSB)	00	01	10	11
Phase shift φ	+ 45°	+135°	-45°	-135°

Table 2-6 Phase shifts for $\pi/4$ DQPSK with coding TETS

Modulation symbol d_n (binary display: MSB, LSB)	00	01	10	11
Phase shift φ	- 135°	+135°	-45°	+45°

2.10.1.3 FSK Modulation

For FSK modulation, frequency shifts are assigned to the modulation symbols. The modulation index h of this digital frequency modulation is determined by

$$h = 2 \cdot \Delta f / f_{\text{Symb}}$$

The symbol rate f_{SYMB} can be freely set to a maximum of 2.5 Msymb/s for all FSK modulations. With GMSK selected, the frequency deviation Δf (FSK deviation) cannot be set since the modulation index is fixed to a value of $h = 0.5$. The following table shows the assignment of modulation symbols and frequency deviations for the different FSK methods.

Table 2-7 Frequency deviations for FSK methods

Mod. symbol	2FSK, GFSK	MSK, GMSK	4FSK	APCO
0	$-\Delta f$	$-\Delta f$	$-\Delta f$	$+\Delta f/3$
1	$+\Delta f$	$+\Delta f$	$-\Delta f/3$	$+\Delta f$
10	-	-	$+\Delta f/3$	$-\Delta f/3$
11	-	-	$+\Delta f$	$-\Delta f$

All FSK modulation methods can be combined with COS, SQR_COS, GAUSS and BESSEL baseband filters. A combination with IS-95 filters is not permissible.

2.10.1.4 Coding

Modulation symbols are coded directly before an assignment of I and Q values or frequency shifts. Coding is thus directly related with modulation methods which is the reason why codings are not freely combinable with modulation methods. The following table shows which combinations are possible.

Table 2-8 Possible combination of modulation method and coding

Coding	Selection CODING	Combinable with MOD TYPE	Example of use
Differential coding	DIFF	all except for 256QAM	
Gray + differential coding	GRAY+DIFF	all except for 256QAM	D8PSK for VDR
GSM differential coding	GSM	FSK, GFSK, GMSK	Mobile radio standard GSM
$\pi/4$ DQPSK differential coding	NADC; PDC;...	$\pi/4$ DQPSK	Mobile radio standards NADC, PDC, PHS, APCO25, TFTS, TETRA
Phase differential coding	INMARSAT	QPSK ISAT	Satellite system INMARSAT-M
Phase differential coding	PHASE DIFF	16 , 32 , 64 , 256 QAM	DVB in line with ETS 300429
VDL coding	VDL	8PSK	VHF Digital Link

The effect of differential coding on $\pi/4$ DQPSK has been described in section 'Modulation $\pi/4$ DQPSK'. Common coding types are listed in the following table.

Table 2-9 Coding algorithms

CODING	Coding algorithm	Applicable for K bit/symbol
NONE	$dc_n = d_n$	K = 1 to 8
DIFF	$dc_n = (d_n + dc_{n-1}) \text{ modulo } 2k$	K = 1 to 7
GRAY+DIFF	Gray coding with additional differential coding	K = 1 to 7
GSM	$dc_n = \text{not } (d_n \text{ exor } d_{n-1})$	K = 1
VDL	VDL standard	K = 3

Example 1: Differential coding for QPSK modulation with K = 2 bit/symbol
 Decimal display; value range for modulation symbols
 $d_n \in \{0;1;2;3\}$

Recursive coding is defined as follows: $dc_n = (d_n + dc_{n-1}) \text{ modulo } 4$.

Depending on the state of a preceding modulation symbol dc_{n-1} the coded modulation symbol dc_n is obtained for example from a modulation symbol $d_n = 2$ as follows:

$d_n = 2$	dc_{n-1}	dc_n
	0	2
	1	3
	2	0
	3	1

By means of differential coding, the assignment between modulation symbols and phase differences shown in the following table is generated:

Modulation symbol d_n (binary, MSB, LSB)	00	01	10	11
Phase difference $\Delta\phi$	0°	90°	180°	270°

Example 2: Gray and differential coding for 8PSK modulation
 First, a gray coding is performed according to the gray code. Afterwards, a differential coding is performed according to the recursive coding algorithm quoted above. By means of the mapping rule shown in the figure in Section 'PSK and QAM Modulation' above, IQ values are assigned to the re-coded modulation symbols. In summary, the assignment between modulation symbols and phase differences shown in the following table is generated:

Modulation symbol d_n (binary, MSB, LSB)	000	001	010	011	100	101	110	111
Phase difference $\Delta\phi$	0°	45°	135°	90°	270°	315°	225°	180°

Differential coding according to VDL is shown in the following table:

Modulation symbol d_n (binary, MSB, LSB)	000	001	010	011	100	101	110	111
Phase difference $\Delta\phi$	0°	45°	135°	90°	315°	270°	180°	225°

Phase differential coding INMARSAT and PHASE DIFF correspond to system standards Inmarsat-M and DVB according to ETS 300 429. The INMARSAT coding can generally be used for modulation types with 2 bit/symbol, such as QPSK. It uses the following algorithm.

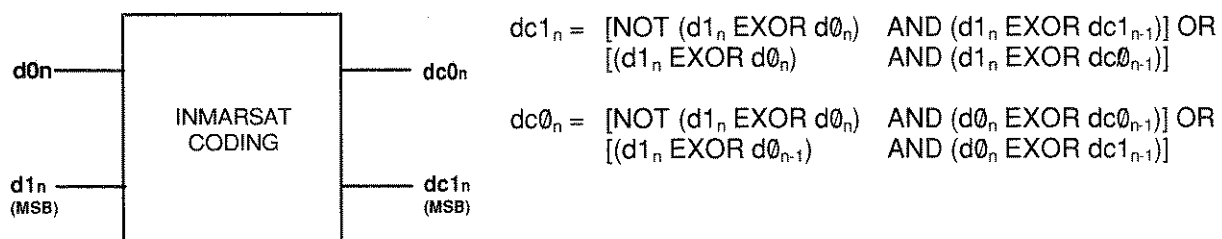

2.10.1.5 Setting Conflicts

As already mentioned in the previous sections, the combination of the above modulation methods with modulation parameters such as symbol rate, filtering and coding is limited. This limitation inevitably causes setting conflicts if a parameter is changed which would lead to an impermissible combination.

Table 2-10 Examples of settings conflicts

	Original status	Change by selection	Conflict	Solution
1	MOD TYPE $\pi/4$ DQPSK SYMBOL RATE 4 Msymb/s	MOD TYPE → GMSK	GMSK is only possible for symbol rates up to 2.5 Msymb/s.	Reduction of symbol rate to a value of <2.5 MHz.
2	MOD TYPE 2FSK FILTER GAUSS FILTER PARAMETER 1.0	FILTER → COS	Filter COS 1.0 not possible, the maximum roll-off factor is 0.7.	Setting of FILTER PARAMETER to a value between 0.15 and 0.7.
3	SYMBOL RATE 270 ksymb/s POWER RAMP INT	SYMBOL RATE → 5 Msymb/s	Envelope control is only possible for symbol rates up to 2.5 Msymb/s.	Switch-off of envelope control.

If SMIQ cannot resolve a setting conflict, error message SETTINGS CONFLICT is indicated in the status line of the display. In this case, SMIQ uses the user-defined setting in the display. However, the generated modulation signal does not correspond to this indication. The setting conflict can be eliminated by a change of parameters. Error message SETTINGS CONFLICT disappears as soon as a conflict-free setting is reinstated. For a list of possible setting conflicts and error messages for digital modulation see Annex B, thumbnail divider 7.

2.10.2 Internal Modulation Data and Control Signals from Lists

If SMIQ is equipped with option Data Generator SMIQB11, modulation data and control signals can be stored in a freely programmable data-generator memory. The storage capacity in the basic configuration is 4 Mbit but can be extended by 8 Mbit or 16 Mbit by fitting one or two SMIQ B12 options.

The data are managed via so-called lists. 125 lists can be stored at maximum for modulation data or control signals. A list editor allows to select, copy, change and delete data lists. For a detailed description of the list editor see Section 2.2.4, List Editor.

There are two types of lists, the DATA LIST and the CONTROL LIST.

Lists, as a source for modulation data, can be selected in the menu by entering SOURCE -SOURCE-DATA_LIST and the active list by SOURCE-SELECT DATA LIST.

Lists, as a source for control signals, can be selected in the menu by entering SOURCE -CONTROL STATE ON and the active list by SOURCE-SELECT CONTROL LIST.

Note: *With DATA LIST selected as a source for internal modulation data, the control signals too have to come from a list. In this case, the setting POWER RAMP CONTROL- SOURCE EXTERN DIGITAL issues an error message*
With CONTROL LIST selected as a source for control signals, the modulation data too have to come from a list.

Data Lists:

The DATA LIST has a bit-by-bit layout. The length of the programmed data sequence and the available storage capacity are indicated in the status line of the display.

SELECT LIST...									DLIST0
EDIT DATA LIST...									
-BIT-----	-----DATA-----								
00000001	1010	1110	0011	1011	1101	1111	1110	1100	
00000033	0100	1010	1001	0101	1110	1011	1011	0010	
00000065	0000	1001	1110	0001	0101	0101	0010	1011	
00000097	1111	0110	1110	1000	1101	0100	1100	0100	
00000129	1001	0111	0100	0001	0010	1110	1110	1010	
00000161	1101	0110	1111	0111	1111	1111	1000	0100	
00000193	0000	0010	1000	0001	1111	0101	1101	0101	
00000225	0110	0111	1100	0000	0111	1111	1111	1111	

Fig. 2-44 DATA LIST for modulation data

Control Lists:

A CONTROL LIST can be created to generate control signals that have to be synchronous to the modulation symbols. The CONTROL LIST has a bit-by-bit layout. Six different control signals can be freely programmed. The CONTROL LIST can be created such that entries are only made at those symbol positions where a control signal is changed. The length of the CONTROL LIST is determined by the symbol number of the last entry and can differ from that of the DATA LIST.

SELECT LIST...	CLIST0					
EDIT CONTROL LIST	COPY		DELETE		EDIT	VIEW
-SYMBOL-----	BGATE	LATT	CW	HOP	TRIG2	TRIG1
00000001	1	0	0	0	0	1
00000157	1	1	0	0	1	0
00000313	0	1	0	0	0	0
00001249	0	1	0	1	0	0
00001250	0	1	0	0	0	0

Fig. 2-45 CONTROL LIST for control signals

Signals BGATE (Burst Gate) and LATT (Level Attenuation) are used for envelope control. Envelope control with these signals is switched on by selecting SOURCE-CONTROL STATE ON and POWER RAMP CONTROL - SOURCE INT.

Digital modulation can be switched off by the CW (Continuous Wave) signal. HOP

TRIG 1 and TRIG 2 (Trigger Output 1 and 2) can be used to generate synchronization signals such as frame clocks, start markers of a PRBS sequence or a special modulation symbol.

Signals BGATE, LATT, HOP and CW are used internally by SMIQ but not signals TRIG 1 and TRIG 2. All the control signals are available at the PAR DATA interface at the rear of SMIQ.

The data sequences stored in the data generator can be run repetitively (TRIGGER MODE AUTO). Moreover, trigger signals can be used for synchronized sequences. Trigger signals can be fed in via the TRIGIN input at connector PAR DATA. A trigger event can be initiated manually by EXECUTE TRIGGER. A trigger signal is generated upon the trigger event at the output TRIGOUT 3.

After a trigger event, the data generator starts to output modulation data from the active list starting with bit 1. In case of external triggering, the start can be delayed by a selectable number of symbols (EXT TRIGGER DELAY). Retriggering (RETRIG) can be inhibited for a selectable number of symbols (EXT TRIGGER INHIBIT).

2.10.3 Internal PRBS Data and Pattern

The PRBS generators in the modulation coder provide pseudo random binary sequences (PRBS) of different length and period. They are called sequences of maximum length and are generated by means of feedback shift registers.

The following schematic shows the 9-bit generator with feedback from registers 4 and 0 (output).

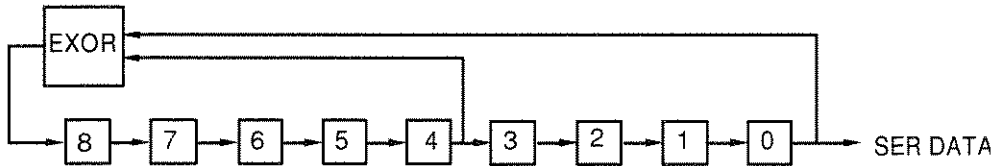

Fig. 2-46 9-bit PRBS generator

The pseudo random sequence of a PRBS generator is determined by the number of registers and the feedback. The following table describes all available PRBS generators:

Table 2-11 PRBS generators of modulation coder

PRBS generator	Length in bit	Feedback to
9 Bit	$2^9 - 1 = 511$	Register 4, 0
15 Bit	$2^{15} - 1 = 32767$	Register 1, 0
16 Bit	$2^{16} - 1 = 65535$	Register 5, 3, 2, 0
20 Bit	$2^{20} - 1 = 1048575$	Register 3, 0
21 Bit	$2^{21} - 1 = 2097151$	Register 2, 0
23 Bit	$2^{23} - 1 = 8388607$	Register 5, 0

PRBS data as a source for modulation data are selected in the menu via SOURCE - SOURCE PRBS. The period is determined by PRBS LENGTH.

Other internal modulation data are available as simple data patterns such as 0s or 1s. Selection is via SOURCE - SOURCE PATTERN.

Note: With PRBS data or Pattern selected as source for modulation data, only external control signals can be used. A combination with control signals from lists is not possible.

2.10.4 Digital Data and Clock output Signals

2.10.4.1 Serial Interfaces DATA, BIT CLOCK and SYMBOL CLOCK

The following figure shows an example for the output signals at the serial interface for QPSK modulation (2 bits per symbol). A positive CLOCK EDGE is assumed to be set. The following list containing 4 symbols (8 bits) was used as a data source.

```

SELECT LIST...                               DLIST00
EDIT DATA LIST...
-BIT-----DATA-----
00000001      0001 1011
    
```

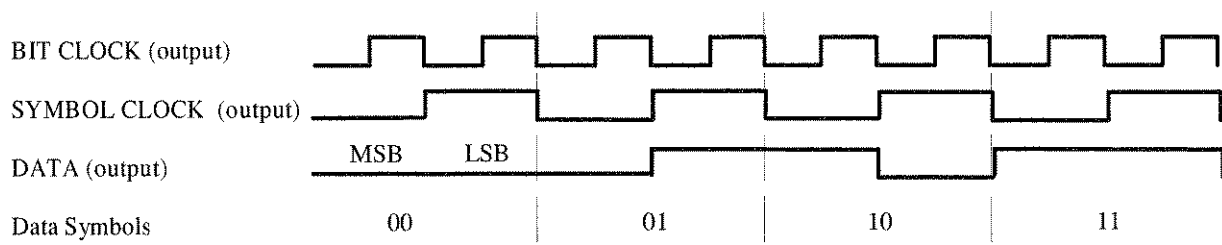

2.10.4.2 Parallel Interfaces DATA and SYMBOL CLOCK

The following figure shows an example for the output signals at the parallel interface. A positive CLOCK EDGE is assumed to be set.

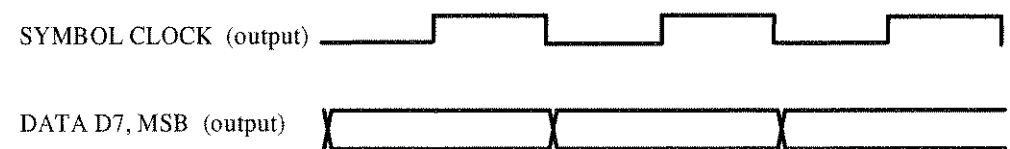

2.10.5 External Modulation Data and Control Signals

Digital modulation signals such as data, clock and signals for envelope control can be externally applied to the modulation coder either via the parallel PAR DATA interface at the rear of SMIQ or via the serial interface with BNC connectors DATA, BIT CLOCK and SYMBOL CLOCK. Moreover, the asynchronous serial interface SERDATA can be used. For a detailed description of the interface hardware see Section Elements at the Rear Panel".

The data source is selected in menu DIGITAL MOD - SOURCE. The clock source is selected in menu DIGITAL MOD - CLOCK irrespective of the data source selection. The polarity of the active clock edge can be changed via DIGITAL MOD - EXT INPUTS - CLOCK SLOPE.

2.10.5.1 External Serial Modulation Data

Serial modulation data can be fed bit-by-bit via connector DATA. For modulation types with more than 1 bit/symbol, the MSB is applied first (MSB first). Either an external bit clock or symbol clock or the internal clock can be used. The symbol clock serves as strobe to mark the LSB of a symbol. If an external bit clock is applied, the data at the active clock edges have to be in a stable state. With external symbol clock, the bit clock for reading the data is internally generated in the modulation coder (internal data clock). The following figures show the timing at the interface. In all the cases shown, the active clock edge is assumed to be positive.

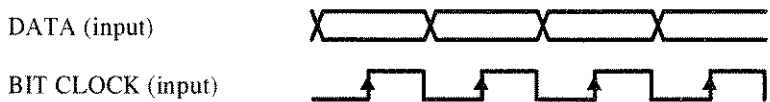

Fig. 2-47 External serial data and bit clock. Data change should take place only on the negative clock edge.

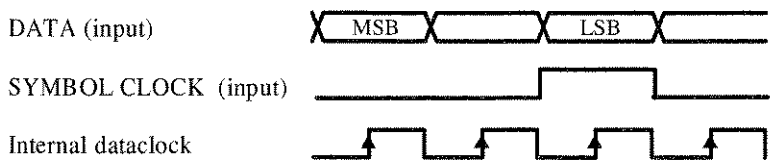

Fig. 2-48 External serial data and symbol clock, 3 bit/symbol. SYMBOL CLOCK = High marks the LSB. A status change of DATA and SYMBOL CLOCK should be performed synchronously.

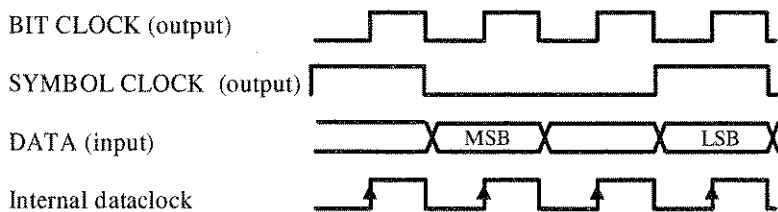

Fig. 2-49 External serial data, internal clock signals

External serial modulation data is selected in the menu by SOURCE-SOURCE-EXT_SER.

2.10.5.2 External Parallel Modulation Data

Parallel data can be fed as symbols via the PAR DATA interface (DATA-D7, -D6 to D0). Either an external symbol clock (SYMBCLK) or the internal symbol clock can be used. The data at the active edge of the symbol clock have to be in a stable state. The following figures show the timings at the interface. In the two examples shown below, the active clock edge is assumed to be positive.



Fig. 2-50 External parallel data and symbol clock. Data change should take place only on the negative clock edge.

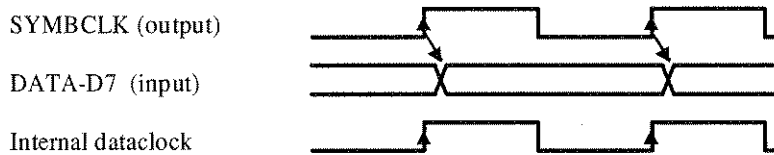

Fig. 2-51 External parallel data and symbol clock. SYMBOL CLOCK = High marks the LSB. A status change of DATA and SYMBOL CLOCK should be performed synchronously.

External serial modulation data is selected in the menu by SOURCE-SOURCE-EXT_SER.

For modulation types with less than 8 bit/symbol, line DATA-D7 is always the MSB. For QPSK modulation, for example (2 bit/symbol), data lines DATA-D7 and DATA-D6 are used.

Note: *BITCLK pin on the PARDATA interface is an output. Synchronization to an external bit clock is not possible in this mode.*

External parallel modulation data is selected in the menu by SOURCE-SOURCE-EXT_PAR.

2.10.5.3 Asynchronous Interface for External Modulation Data

The SERDATA interface on the rear of SMIQ serves for the asynchronous serial transmission of modulation data. The characteristics of this RS-232-C interface is described in Annex A.

For a defined start with specific modulation data it has to be made sure that the backup memories in the RS-232 transmitter and receiver are deleted. The following setting sequence in the menu is required:

1. Carry out desired settings for digital modulation in menu.
2. Select data source SERDATA using SOURCE - SOURCE SERDATA.
3. Make connection to external data source, but do not yet start external data source.
4. Switch off digital modulation using STATE OFF.
5. Set TRIGGER MODE ARMED_AUTO.
In this state, SMIQ is ready for reception, but discards data that are read in via SERDATA.
6. Switch on digital modulation with STATE ON.
7. Start external data source.
The read-in data are written into the receiving buffer. Only if this buffer is filled can SMIQ react to a trigger event.
8. Activate trigger event to start digital modulation.

Note: *The baud rate has to be selected at least 25% higher than the bit rate of the digital modulation. If SMIQ has not enough data, the error message "Data underrun" will be issued in the status line.*

2.10.5.4 External Control Signals

The external control signals for envelope control BURST GATE and LEV ATT can be applied via the SERDATA interface at the rear of SMIQ. The signal for CW control can also be applied to this interface.

Note: *The use of control signals from lists in combination with external modulation data is not possible.*

2.10.6 Envelope Control

For TDMA radio networks, in addition to digital modulation, a time-synchronous control of the envelope of the RF output signal is required. To this effect, SMIQ is equipped with an analog envelope modulator which can be driven via connector POWER RAMP. Instead of the analog control signal the digital signals BURST GATE and LEV ATT can be used to control the envelope modulator. In the modulation coder, a ramp with settable slope is obtained from data changes from high→low or low→high of the digital BURST GATE signal. The resulting analog signal is taken to the envelope modulator and is provided at connector POWER RAMP. The LEV ATT signal serves for a defined level reduction.

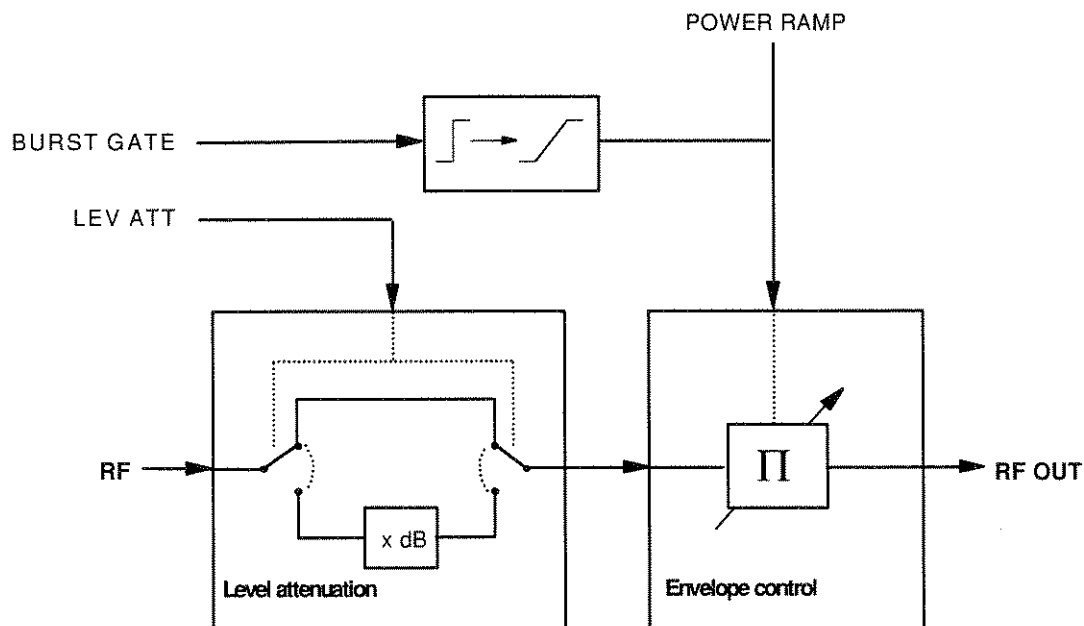

Fig. 2-52 Envelope control in SMIQ with modulation coder

The digital envelope control signals can be fed in externally via connector PAR DATA. With option Data Generator SMIQB11 provided, the signals can also be generated internally by programming them in the CONTROL LIST (see Section "Modulation Data from Lists").

The following table shows the logic function of the two signals BURST GATE and LEVEL ATT.

Table 2-12 Logic function of signals BURST GATE and LEVEL ATT

BURST GATE	LEV ATT	Remark
1	0	Full level
1	1	Level reduced by the value set in dB under POWER RAMP CONTROL - ATTENUATION
0	X	Maximum level reduction

The following figure illustrates the effect of the envelope control signals.

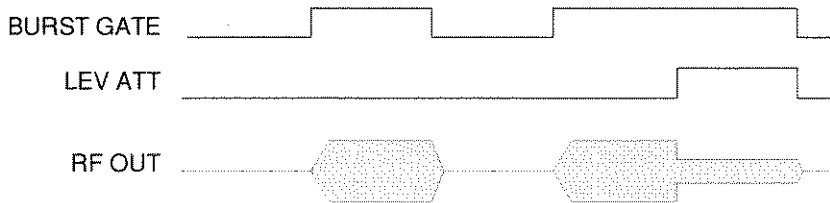

Fig. 2-53 Signal waveforms during envelope control

Note: *Envelope control with digital input signals and edge shaping is only possible for symbol rates of maximum 2.5 Msymb/s.*

Envelope control is switched on in the menu via:

- analog POWER RAMP CONTROL - SOURCE - EXT ANALOG.
- external digital POWER RAMP CONTROL - SOURCE - EXT DIGITAL.
- internal digital POWER RAMP CONTROL - SOURCE - INT and SOURCE CONTROL STATE ON.

2.10.7 Clock Signals

The symbol clock and the bit clock are generated in SMIQ by a clock synthesizer on the modulation coder. All clock signals are synchronized to the 10 MHz reference of the unit. The symbol clock is available at the SYMBOL CLOCK connector and the bit clock at the BIT CLOCK connector. If required, the clock synthesizer in SMIQ can synchronize to an externally applied symbol or bit clock. Only during an operation with external parallel data is synchronization to one symbol clock possible. This symbol clock is applied via the PAR DATA interface. In all other cases, apply symbol and bit clock to the corresponding BNC connector.

The clock signal is selected in the menu via CLOCK-MODE SYMBOL/BIT and CLOCK-CLOCK SOURCE EXT.

To allow for a trouble-free synchronization of the clock synthesizer first apply the external clock and set the correct symbol rate at SMIQ. Then switch CLOCK SOURCE from INT to EXT.

Notes: *The set symbol rate should not differ by more than 1% from the symbol rate of the external signal.*

2.10.8 RF Level For Digital Modulation

With modulation switched on, a level display divided in half appears in the header of the display. The peak envelope power (PEP) of the modulated RF output level is displayed in addition to average power (LEVEL).

The difference between PEP and LEVEL depends on the modulation type and the filtering. The power of QAM signals is calculated on the assumption of a uniform distribution of modulation symbols. For the PEP calculation, it is always assumed that the most unfavourable case occurs in the sequence of modulation data. This is definitely the case for PRBS data with a long period (eg PRBS LENGTH 23 bit). For other data sequences it is possible that the indicated PEP is not attained.

2.10.9 Digital Modulation Menu

The DIGITAL MOD menu provides access to digital modulation settings.

Menu selection: DIGITAL MOD

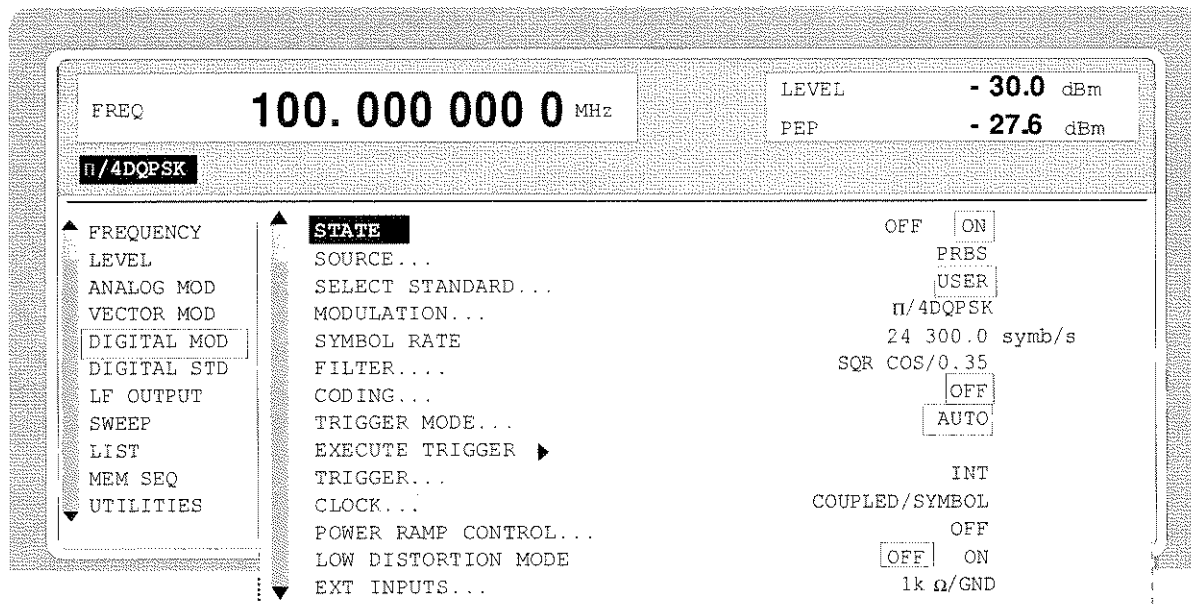

Fig. 2-54 DIGITAL MOD menu, SMIQ equipped with option Modulation Coder SMIQB10 and option Data Generator SMIQB11

STATE Switch on/off of digital modulation.
IEC/IEEE-bus command SOUR:DM:STAT ON

SOURCE... Opens a window for defining the data source for digital modulation. Menu selection depends on option SMIQB11. If option SMIQB11 is installed, the menu provides more selections and settings for modulation data from lists.

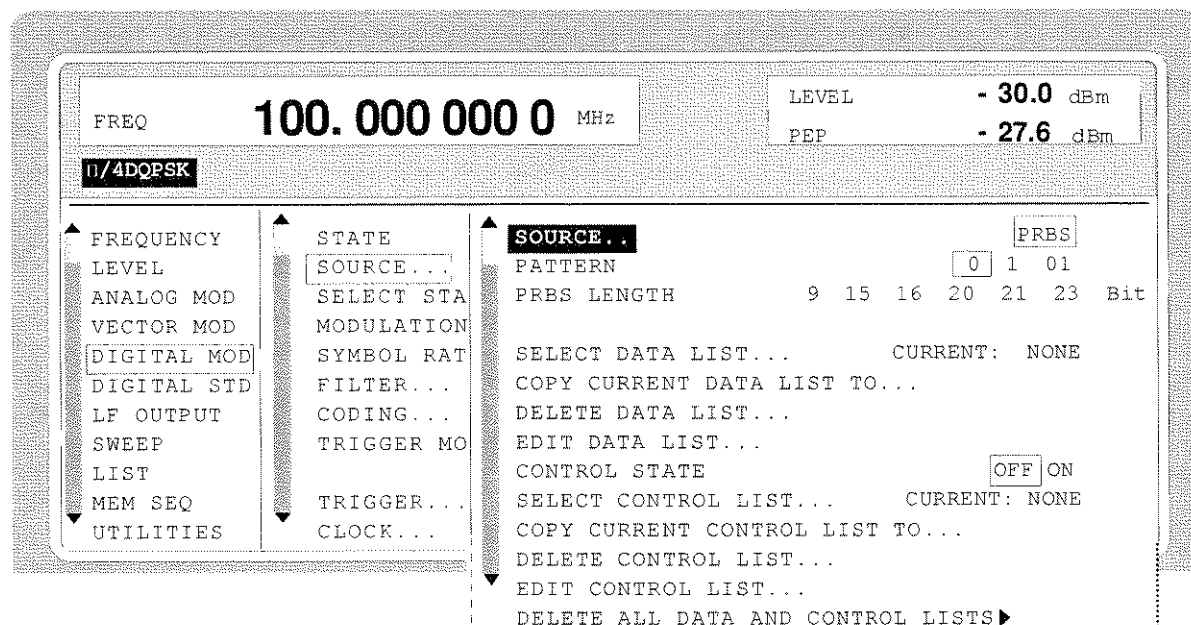

Fig. 2-55 DIGITAL MOD-SOURCE menu, SMIQ equipped with option Modulation Coder SMIQB10 and option Data Generator SMIQB11.

(SOURCE...)	SOURCE...	<p>Opens a window for selecting the source for modulation data.</p> <p>EXT_PAR The modulation data are fed in via the parallel PAR DATA interface at the rear of SMIQ. IEC -bus SOUR:DM:SOUR PAR</p> <p>EXT_SER The modulation data are fed in serially at input DATA. IEC -bus SOUR:DM:SOUR SER</p> <p>PATTERN A simple data pattern is continuously generated. IEC-bus SOUR:DM:SOUR PATT</p> <p>PRBS A pseudo random bit sequence is generated and continuously repeated. IEC -bus SOUR:DM:SOUR PRBS</p> <p>SERDATA The modulation data are fed in via the asynchronous SER_DATA interface. IEC -bus SOUR:DM:SOUR SDAT</p> <p>DATA LIST Modulation data from lists IEC-bus SOUR:DM:SOUR DLIS</p>
	PATTERN	<p>Selection of a simple data pattern which is continuously generated.</p> <p>0 0s are continuously generated. IEC -bus SOUR:DM:PATT ZERO</p> <p>1 1s are continuously generated. IEC -bus SOUR:DM:PATT ONE</p> <p>01 010 data changes are continuously generated. IEC -bus SOUR:DM:PATT ALT</p>
	PRBS LENGTH	<p>Setting of PRBS generator length. 9 bit, 15 bit, 16 bit, 20 bit, 21 bit and 23 bit can be selected. The period of the data sequence is then between 2^9-1 and $2^{23}-1$ bit (see Section "PRBS data"). IEC/IEEE-bus command SOUR:DM:PRBS 15</p>
	SELECT DATA LIST	<p>Opens a window for selecting a stored data list or for generating a new list. IEC/IEEE-bus SOUR:DM:DLIS:SEL 'name'</p>
	COPY CURRENT DATA LIST TO	<p>Stores the current data list under a different name. IEC/IEEE-bus SOUR:DM:DLIS:COPY 'name'</p>
	DELETE DATA LIST	<p>Deletes a data list.</p>

(SOURCE...)	EDIT DATA LIST	<p>Opens a window for editing a data list bit-by-bit. The available storage capacity and the length of the current list is displayed in parameters FREE and LEN (see also Section List Editor).</p> <p>COPY Copies a list range</p> <p>FILL Fills the range with filler pattern</p> <p>INSERT Inserts a list range at a different position of the list</p> <p>DELETE Deletes a list range</p> <p>EDIT/VIEW Edits or views the list</p>
	CONTROL STATE	<p>ON The signals from the selected CONTROL LIST are effective.</p> <p>OFF The signals are not effective</p> <p>IEC/IEEE-bus SOUR:DM:CLIS:CONT ON</p>
	SELECT CONTROL LIST	<p>Opens a window for selecting a stored list for control signals or for generating a new list for control signals.</p> <p>IEC/IEEE-bus SOUR:DM:CLIS:SEL 'name'</p>
	COPY CURRENT CONTROL LIST TO	<p>Stores the current list for control signals under a different name.</p> <p>IEC/IEEE-bus SOUR:DM:CLIS:COPY 'name'</p>
	DELETE CONTROL LIST	<p>Deletes a list for control signals.</p>
	EDIT CONTROL LIST	<p>Opens a window for editing a list for control signals symbol-by-symbol. The available storage capacity and the length of the current list is displayed in parameters FREE and LEN (see also Section List Editor).</p> <p>COPY Copies a list range</p> <p>DELETE Deletes a list range</p> <p>EDIT/VIEW Edits or views the list</p>
	DELETE ALL DATA AND CONTROL LISTS ►	<p>Deletes all data lists and lists for control signals.</p> <p>IEC/IEEE-bus -</p>

SELECT STANDARD...

Opens a window for selecting the standard. After the selection, the modulation parameters MODULATION, SYMBOL RATE, FILTER and CODING are automatically adjusted to the standard. USER is indicated if the settings of these parameters do not correspond to the selected standard.. The following standards are available:

APCO4FM	IEC/IEEE-bus command	: SOUR:DM:STAN APCF
APCOQPSK	IEC/IEEE-bus command	: SOUR:DM:STAN APCQ
ICOBPSK	IEC/IEEE-bus command	: SOUR:DM:STAN ICQB
ICOGMSK	IEC/IEEE-bus command	: SOUR:DM:STAN ICQG
ICOQPSK	IEC/IEEE-bus command	: SOUR:DM:STAN ICQQ
IRIDIUM	IEC/IEEE-bus command	: SOUR:DM:STAN IRID
CDPD	IEC/IEEE-bus command	: SOUR:DM:STAN CDPD
CT2	IEC/IEEE-bus command	: SOUR:DM:STAN CT2
DECT	IEC/IEEE-bus command	: SOUR:DM:STAN DECT
GSM	IEC/IEEE-bus command	: SOUR:DM:STAN GSM
NADC	IEC/IEEE-bus command	: SOUR:DM:STAN NADC
PDC	IEC/IEEE-bus command	: SOUR:DM:STAN PDC
PHS	IEC/IEEEbus command	: SOUR:DM:STAN PHS
TETRA	IEC/IEEE-bus command	: SOUR:DM:STAN TETR
TFTS	IEC/IEEE-bus command	: SOUR:DM:STAN TFTS
PWT	IEC/IEEE-bus command	: SOUR:DM:STAN PWT

MODULATION...

Opens a window for defining the modulation method. Moreover, the number of bits per modulation symbol is displayed. See also Section "Digital Modulation Methods and Coding".

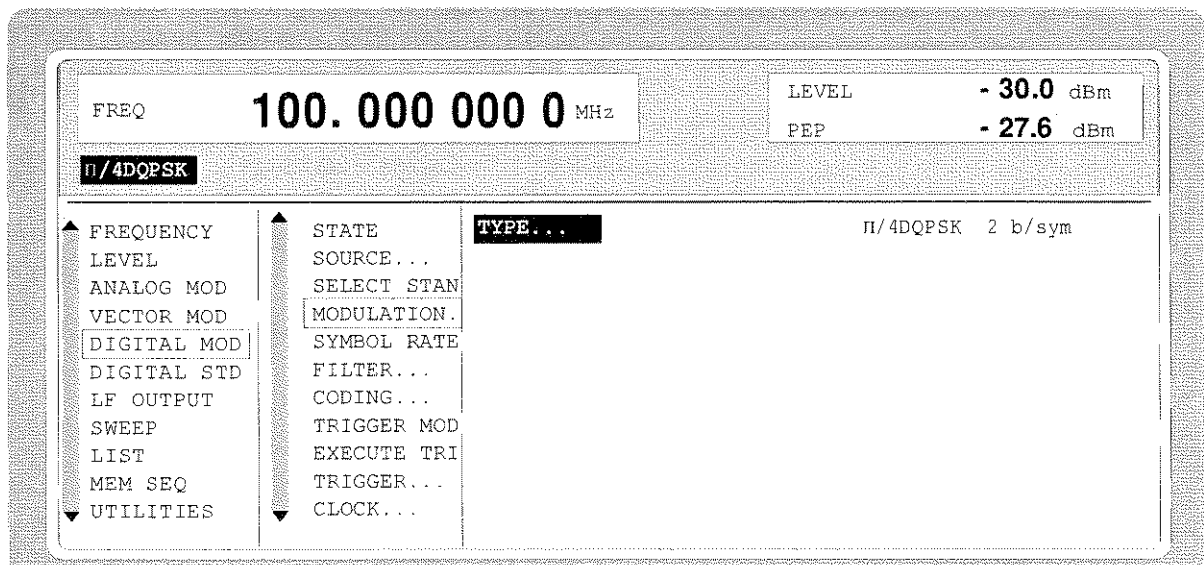

Fig. 2-56 DIGITAL MOD - MODULATION... menu, SMIQ equipped with option Modulation Coder SMIQB10 and option Data Generator SMIQB11

(MODULATION...)	TYPE...	Opens a window for selecting the modulation method. The following modulations can be selected:
	BPSK	Binary Phase Shift Keying IEC/IEEE-bus :DM:FORM BPSK
	QPSK	Quadrature Phase Shift Keying IEC/IEEE-bus :DM:FORM QPSK
	QPSK IS95	Quadrature Phase Shift Keying with a mapping according to Interim Standard 95 for CDMA IEC/IEEE-bus :DM:FORM QIS95
	QPSK ISAT	QPSK Modulation for INMARSAT-M IEC/IEEE-bus :DM:FORM QINM
	QPSK ICO	QPSK Modulation for ICO IEC/IEEE-bus :DM:FORM QICO
	OQPSK	Offset Quadrature Phase Shift Keying IEC/IEEE-bus :DM:FORM OPSK
	OQPSK IS95	Quadrature Phase Shift Keying with a mapping according to Interim Standard 95 for CDMA IEC/IEEE-bus :DM:FORM OIS95
	$\pi/4$ DQPSK	QPSK with differential coding IEC/IEEE-bus :DM:FORM P4DQ
	$\pi/4$ QPSK	QPSK with $\pi/4$ rotation for each symbol step (use: NSTAR) IEC/IEEE-bus :DM:FORM P4QP
	8PSK	Phase Shift Keying with 8 points in the constellation diagram IEC/IEEE-bus :DM:FORM PSK8
	QAM	Quadrature Amplitude Modulation with 16, 32, 64 or 256 points in the constellation diagram IEC/IEEE-bus :DM:FORM QAM16
	FSK, 4FSK	Frequency Shift Keying IEC/IEEE-bus :DM:FORM FSK2
	4FSK APCO	Frequency Shift Keying according to APCO25 IEC/IEEE-bus :DM:FORM AFSK4
	GFSK	Gaussian filtered Frequency Shift Keying IEC/IEEE-bus :DM:FORM GFSK
	GMSK	Gaussian Minimum Shift Keying IEC/IEEE-bus :DM:FORM GMSK
	FSK DEVIATION	Input value of deviation with FSK or GFSK selected. IEC/IEEE-bus SOUR:DM:FSK:DEV 100 KHZ
SYMBOL RATE		Input value of symbol rate. IEC/IEEE-bus command SOUR:DM:SRAT 1.2288 MHZ

FILTER... Opens a window for setting the baseband filtering.

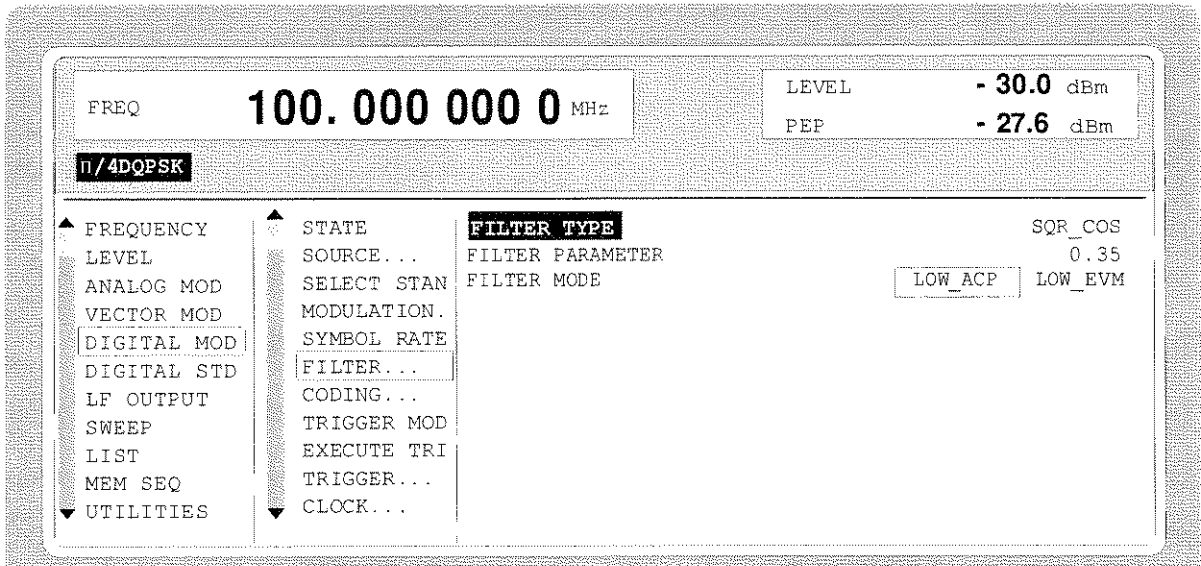

Fig. 2-57 DIGITAL MOD -FILTER... menu, SMIQ equipped with option Modulation Coder SMIQB10 and option Data Generator SMIQB11

(FILTER...)	FILTER TYPE	<p>Opens a window for selecting a type of filter. The following filters can be selected:</p> <p>SQR_COS Square Root RaisedCosine IEC : SOUR:DM:FILT:TYPE SCOS</p> <p>COS Cosine IEC : SOUR:DM:FILT:TYPE COS</p> <p>GAUSS Gaussian filter IEC : SOUR:DM:FILT:TYPE GAUS</p> <p>APCO C4FM Cosine filter with si(x)-compensation according to APCO25 standard for 4FSK modulation. IEC : SOUR:DM:FILT:TYPE APCO</p> <p>BESSEL Bessel filter with B×T = 1.25 or 2.5 IEC : SOUR:DM:FILT:TYPE BESS1</p> <p>IS95 Filter for CDMA mobile station according to Interim Standard 95 IEC : SOUR:DM:FILT:TYPE IS95</p> <p>IS95 EQUAL Filter for CDMA base station with equalizer according to IS-95 IEC : SOUR:DM:FILT:TYPE EIS95</p> <p>WCDMA0.22 Filter for PSK modulation. Square Root Raised Cosine filter with Roll Off = 0.22, optimized for W-CDMA IEC : SOUR:DM:FILT:TYPE WCDM</p> <p>TETRA Filter for PSK/QAM modulation IEC : SOUR:DM:FILT:TYPE TETR</p>
--------------------	--------------------	--

(FILTER...)	<p>FILTER PARAMETER Opens a window for setting the filter parameter. The selection depends on the selected filter type:</p> <table border="0"> <thead> <tr> <th style="text-align: left;">Parameter</th> <th style="text-align: left;">Filter Type</th> </tr> </thead> <tbody> <tr> <td>Roll-off factor Normalized band width $B \times T_{\text{Symb}}$</td> <td>SQR COS, COS, o. APCO:</td> </tr> <tr> <td>IEC/IEEE-bus</td> <td>SOUR:DM:FILT:PAR 0.2</td> </tr> </tbody> </table> <p>FILTER MODE Selection of filter mode.</p> <table border="0"> <tbody> <tr> <td>LOW_ACP</td> <td>Filter for minimum <u>A</u>djacent <u>C</u>hannel <u>P</u>ower IEEE SOUR:DM:FILT:MODE LACP</td> </tr> <tr> <td>LOW_EVM</td> <td>Filter for minimum vector error IEEE SOUR:DM:FILT:MODE LEVM</td> </tr> </tbody> </table>	Parameter	Filter Type	Roll-off factor Normalized band width $B \times T_{\text{Symb}}$	SQR COS, COS, o. APCO:	IEC/IEEE-bus	SOUR:DM:FILT:PAR 0.2	LOW_ACP	Filter for minimum <u>A</u> djacent <u>C</u> hannel <u>P</u> ower IEEE SOUR:DM:FILT:MODE LACP	LOW_EVM	Filter for minimum vector error IEEE SOUR:DM:FILT:MODE LEVM																
Parameter	Filter Type																										
Roll-off factor Normalized band width $B \times T_{\text{Symb}}$	SQR COS, COS, o. APCO:																										
IEC/IEEE-bus	SOUR:DM:FILT:PAR 0.2																										
LOW_ACP	Filter for minimum <u>A</u> djacent <u>C</u> hannel <u>P</u> ower IEEE SOUR:DM:FILT:MODE LACP																										
LOW_EVM	Filter for minimum vector error IEEE SOUR:DM:FILT:MODE LEVM																										
CODING...	<p>Opens a window for setting the modulation coding. See also Section " Digital Modulation Methods and Coding. The following codings can be selected:</p> <table border="0"> <tbody> <tr> <td>OFF</td> <td>No coding IEC-bus command : SOUR:DM:COD OFF</td> </tr> <tr> <td>DIFF</td> <td>Differential coding IEC-bus command : SOUR:DM:COD DIFF</td> </tr> <tr> <td>PHASE_DIFF</td> <td>Phase differential coding IEC-bus command : SOUR:DM:COD DPHS</td> </tr> <tr> <td>GRAY+DIFF</td> <td>Gray- and differential coding IEC-bus command : SOUR:DM:COD DGR</td> </tr> <tr> <td>NADC</td> <td>Differential coding for $\pi/4$ DQPSK according to NADC standard IEC-bus command : SOUR:DM:COD NADC</td> </tr> <tr> <td>PDC</td> <td>Differential coding according to PDC standard IEC-bus command : SOUR:DM:COD PDC</td> </tr> <tr> <td>PHS</td> <td>Differential coding according to PHS standard IEC-bus command : SOUR:DM:COD PHS</td> </tr> <tr> <td>TETRA</td> <td>Differential coding for $\pi/4$ DQPSK according to TETRA standard IEC-bus command : SOUR:DM:COD TETR</td> </tr> <tr> <td>APCO25</td> <td>Differential coding according to APCO25 standard IEC-bus command : SOUR:DM:COD APCO25</td> </tr> <tr> <td>PWT</td> <td>Differential coding for $\pi/4$ DQPSK according to PWT standard IEC-bus command : SOUR:DM:COD PWT</td> </tr> <tr> <td>TFTS</td> <td>Differential coding for $\pi/4$ DQPSK according to TFTS standard IEC-bus command : SOUR:DM:COD TFTS</td> </tr> <tr> <td>INMARSAT</td> <td>Phase differential coding for INMARSAT-M QPSK modulation IEC-bus command : SOUR:DM:COD INM</td> </tr> <tr> <td>VDL</td> <td>Differential coding according to VDL (VHF Digital Link) for 8PSK modulation. IEC-bus command : SOUR:DM:COD VDL</td> </tr> </tbody> </table>	OFF	No coding IEC-bus command : SOUR:DM:COD OFF	DIFF	Differential coding IEC-bus command : SOUR:DM:COD DIFF	PHASE_DIFF	Phase differential coding IEC-bus command : SOUR:DM:COD DPHS	GRAY+DIFF	Gray- and differential coding IEC-bus command : SOUR:DM:COD DGR	NADC	Differential coding for $\pi/4$ DQPSK according to NADC standard IEC-bus command : SOUR:DM:COD NADC	PDC	Differential coding according to PDC standard IEC-bus command : SOUR:DM:COD PDC	PHS	Differential coding according to PHS standard IEC-bus command : SOUR:DM:COD PHS	TETRA	Differential coding for $\pi/4$ DQPSK according to TETRA standard IEC-bus command : SOUR:DM:COD TETR	APCO25	Differential coding according to APCO25 standard IEC-bus command : SOUR:DM:COD APCO25	PWT	Differential coding for $\pi/4$ DQPSK according to PWT standard IEC-bus command : SOUR:DM:COD PWT	TFTS	Differential coding for $\pi/4$ DQPSK according to TFTS standard IEC-bus command : SOUR:DM:COD TFTS	INMARSAT	Phase differential coding for INMARSAT-M QPSK modulation IEC-bus command : SOUR:DM:COD INM	VDL	Differential coding according to VDL (VHF Digital Link) for 8PSK modulation. IEC-bus command : SOUR:DM:COD VDL
OFF	No coding IEC-bus command : SOUR:DM:COD OFF																										
DIFF	Differential coding IEC-bus command : SOUR:DM:COD DIFF																										
PHASE_DIFF	Phase differential coding IEC-bus command : SOUR:DM:COD DPHS																										
GRAY+DIFF	Gray- and differential coding IEC-bus command : SOUR:DM:COD DGR																										
NADC	Differential coding for $\pi/4$ DQPSK according to NADC standard IEC-bus command : SOUR:DM:COD NADC																										
PDC	Differential coding according to PDC standard IEC-bus command : SOUR:DM:COD PDC																										
PHS	Differential coding according to PHS standard IEC-bus command : SOUR:DM:COD PHS																										
TETRA	Differential coding for $\pi/4$ DQPSK according to TETRA standard IEC-bus command : SOUR:DM:COD TETR																										
APCO25	Differential coding according to APCO25 standard IEC-bus command : SOUR:DM:COD APCO25																										
PWT	Differential coding for $\pi/4$ DQPSK according to PWT standard IEC-bus command : SOUR:DM:COD PWT																										
TFTS	Differential coding for $\pi/4$ DQPSK according to TFTS standard IEC-bus command : SOUR:DM:COD TFTS																										
INMARSAT	Phase differential coding for INMARSAT-M QPSK modulation IEC-bus command : SOUR:DM:COD INM																										
VDL	Differential coding according to VDL (VHF Digital Link) for 8PSK modulation. IEC-bus command : SOUR:DM:COD VDL																										

- TRIGGER MODE** Selection of trigger mode.
This selection is only available when option SMIQB11 is installed.
- AUTO** The data sequences from the selected DATA LIST and CONTROL LIST are continuously repeated.
IEC/IEEE-bus command SOUR:DM:SEQ AUTO
 - RETRIG** The data sequences are continuously repeated. A trigger event causes a restart from symbol 1.
IEC/IEEE-bus command SOUR:DM:SEQ RETR
 - ARMED_AUTO** A start of data sequences from symbol 1 is caused by a trigger event. The unit is then automatically set to AUTO and can no longer be triggered.
IEC/IEEE-bus command SOUR:DM:SEQ AAUT
 - ARMED_RETRIG** A start of data sequences from symbol 1 is only caused by a trigger event. The unit is then automatically set to RETRIG. Each new trigger event causes a restart of the data sequences.
IEC/IEEE-bus command SOUR:DM:SEQ ARET
 - SINGLE** A trigger event causes a single data sequence run.
IEC/IEEE-bus command SOUR:DM:SEQ SING
- EXECUTE TRIGGER** ▶ Executes a trigger event to start a data sequence.
IEC/IEEE-bus command :TRIG:DM IMM
- TRIGGER...** Opens a window for setting the different types of trigger and for setting the time delay of the trigger signal. The menu is only available if SMIQ is equipped with option Data Generator SMIQB11.

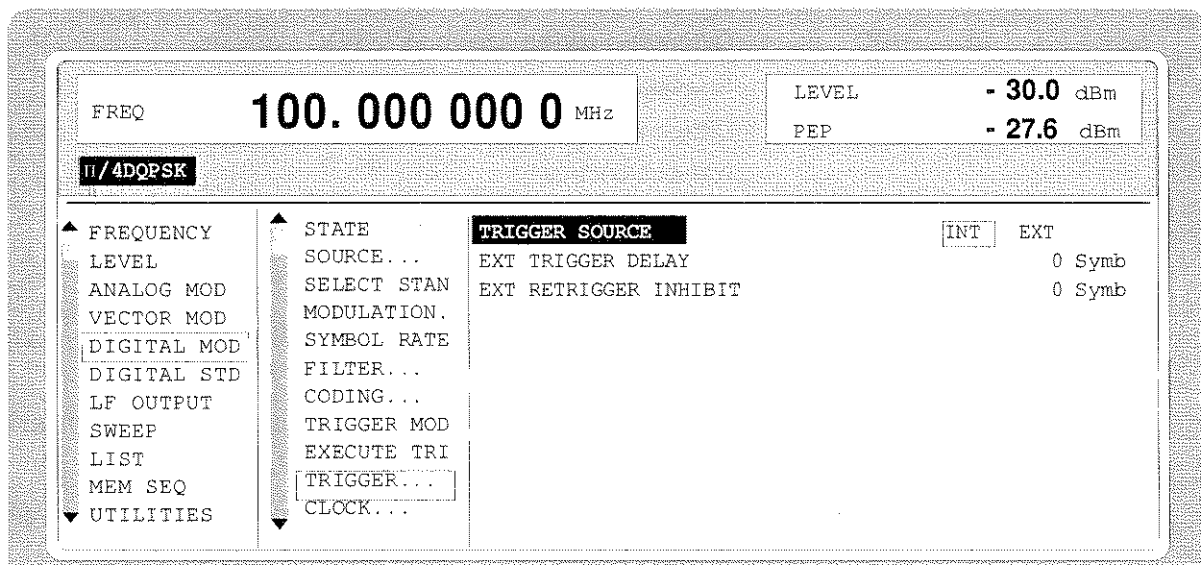

Fig. 2-58 DIGITAL MOD - TRIGGER menu, SMIQ equipped with option Modulation Coder SMIQB10 and option Data Generator SMIQB11

(TRIGGER...)	TRIGGER SOURCE	<p>Selection of trigger source</p> <p>EXT An external trigger signal can be fed in at TRIGIN of connector PAR DATA at the rear of SMIQ. With the active edge, a data sequence is started from the data generator memory.</p> <p>INT With INT selected, a trigger event can be manually executed by EXECUTE TRIGGER.</p> <p>IEC/IEEE-bus SOUR:DM:TRIG:SOUR EXT</p>
	EXT TRIGGER DELAY	<p>Input value of number of symbols by which an external trigger signal is delayed before it starts the data sequence in the data generator. A synchronicity with the DUT or other units can thus be achieved.</p> <p>IEC/IEEE-bus SOUR:DM:TRIG:DEL 3</p>
	EXT RETRIGGER INHIBIT	<p>Input of number of symbols for which each new trigger event is inhibited during MODE RETRIG after a trigger signal.</p> <p>During MODE RETRIG, each new trigger signal restarts the data sequence in the data generator. This restart can be inhibited for the entered number of symbols. The entry of 1250 symbols, for example, causes new trigger signals to be ignored for the duration of 1250 symbols after execution of a trigger event.</p> <p>IEC/IEEE-bus SOUR:DM:TRIG:INH 1250</p>

CLOCK... Opens a window for selecting the clock source and for setting a delay.

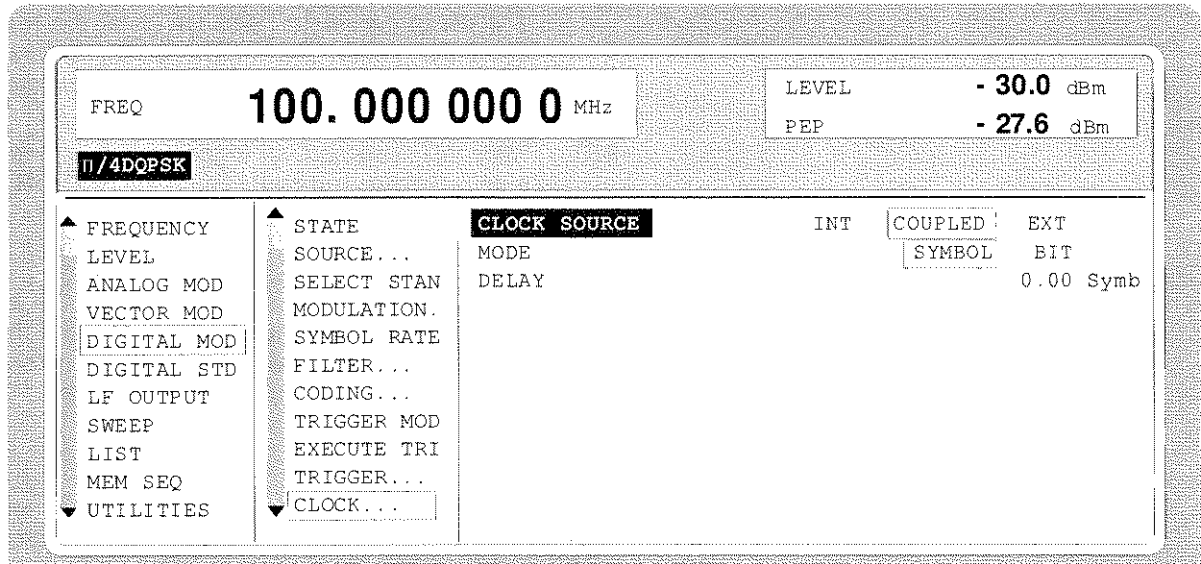

Fig. 2-59 DIGITAL MOD - CLOCK, SMIQ equipped with option Modulation Coder SMIQB10 and option Data Generator SMIQB11

(CLOCK...)	CLOCK SOURCE	Selection of clock source
		INT The symbol and the bit clock in SMIQ are generated by a clock synthesizer on the modulation coder. All the clock signals are synchronized to the 10-MHz reference of the unit. IEEE-bus SOUR:DM:CLOC:SOUR INT
		COUPLED The clock comes from the same source as the data. IEEE-bus SOUR:DM:CLOC:SOUR COUP
		EXT An external clock signal is fed externally. The clock synthesizer on the modulation coder is synchronized to this clock. Parameter SYMBOL RATE has to be correctly set with an accuracy of ± 1%. IEEE-bus SOUR:DM:CLOC:SOUR EXT
	MODE	Selection of clock for the external clock signal
		SYMBOL An externally fed clock has to be a symbol clock.
		BIT An externally fed clock has to be a bit clock.
		IEC/IEEE-bus SOUR:DM:CLOC:MODE SYMB

(CLOCK...)

DELAY

Input value of delay of generated modulation signal compared with an externally fed clock. This can be used, for example, for synchronization with a second unit to achieve time synchronicity between the modulation signals of the two units. The displayed setting resolution of 1/100 symbol is only attained for symbol-clock frequencies below 100 kHz. The actual resolution is reduced with increasing frequency. The delay can no longer be set for 7 Msymb/s.

IEC/IEEE-bus SOUR:DM:CLOC:DEL 0.5

POWER RAMP CONTROL...

Opens a window for setting the envelope control.

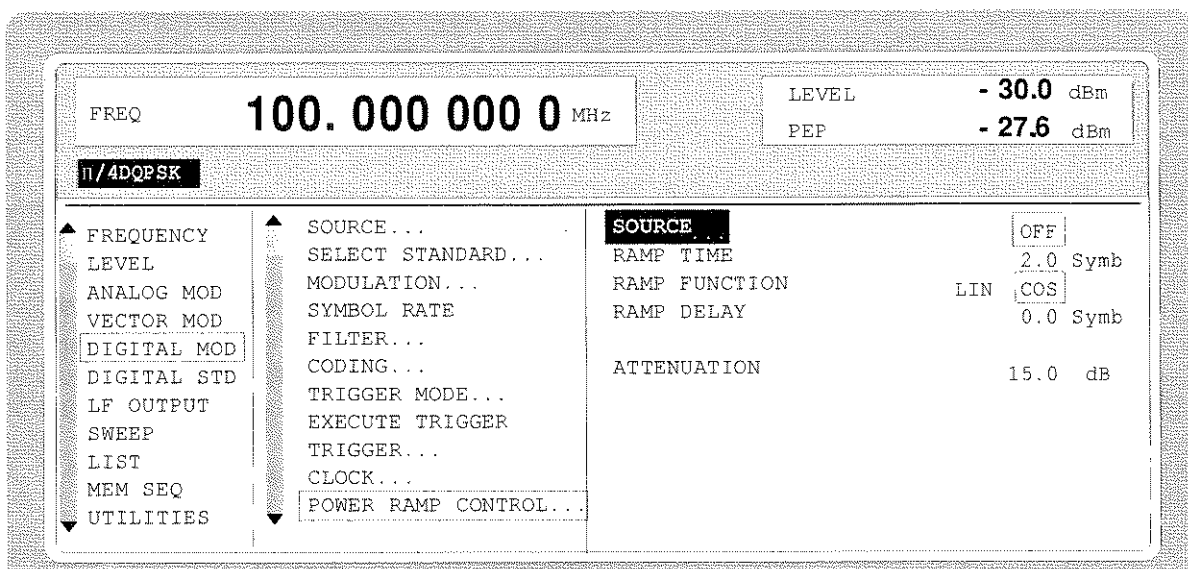

Fig. 2-60 DIGITAL MOD - POWER RAMP CONTROL menu, SMIQ equipped with option Modulation Coder SMIQB10 and option Data Generator SMIQB11

(POWER RAMP CONTROL...)

SOURCE

Selection between analog and digital envelope control and selection of source.

OFF Envelope control is switched off.

IEC/IEEE SOUR:DM:PRAM:STAT OFF

INT Signals BGAT and LATT from the active CONTROL LIST (CLIST) are used for envelope control (only with option SMIQB11)

IEC/IEEE SOUR:DM:PRAM:STAT ON

SOUR:DM:PRAM:SOUR CLIST

(POWER RAMP CONTROL...)	(SOURCE)	<p>EXT_ANALOG Envelope control is via an external analog signal that can be fed in via connector POWER RAMP.</p> <p>IEC/IEEE-bus commands SOUR:DM:PRAM:STAT ON SOUR:DM:PRAM:SOUR AEXT</p>
		<p>EXT_DIGITAL Envelope control is via external digital signals to be applied to BURST GATE and LEV ATT of connector PAR DATA.</p> <p>IEC/IEEE-bus commands SOUR:DM:PRAM:STAT ON SOUR:DM:PRAM:SOUR DEXT</p>
	RAMP TIME	<p>Input value of rise time of envelope after a transition from Low→High of signal BURST GATE and of fall time after a transition from High→Low. The setting is a multiple of the symbol duration.</p> <p>IEC/IEEE-bus SOUR:DM:PRAM:TIME 3.0</p>
	RAMP FUNCTION	<p>Determines the shape of the rising and falling edge during envelope control by means of the BURST GATE signal.</p> <p>LIN Selection of a linear ramp function.</p> <p>COS The edge is shaped according to a cosine function and a more favourable spectrum than that under setting LIN is obtained.</p> <p>IEC/IEEE-bus SOUR:DM:PRAM:SHAP COS</p>
	RAMP DELAY	<p>Input value for a shift of the envelope characteristic to the modulated signal. A positive value causes a delay of the envelope. The values are set in the units of the symbol length.</p> <p>IEC/IEEE-bus SOUR:DM:PRAM:DEL 0.1</p>
	ATTENUATION	<p>Input value of level reduction in dB with digital control signal LEV ATT used. This function is normally used - for TDMA frame structures - to generate a slot with reduced level.</p> <p>IEC/IEEE-bus SOUR:DM:PRAM:ATT 0 dB</p>
LOW DISTORTION MODE		<p>After switch-on (ON), the level of the IQ baseband signals is reduced by 3 dB. In some cases, this might reduce undesired intermodulation products. OFF is normally the more favourable setting.</p>

EXT INPUTS

Opens a window for setting the trigger threshold, input impedance and polarity of the external digital modulation coder inputs, ie connector PAR DATA and inputs DATA, BIT CLOCK and SYMBOL CLOCK.

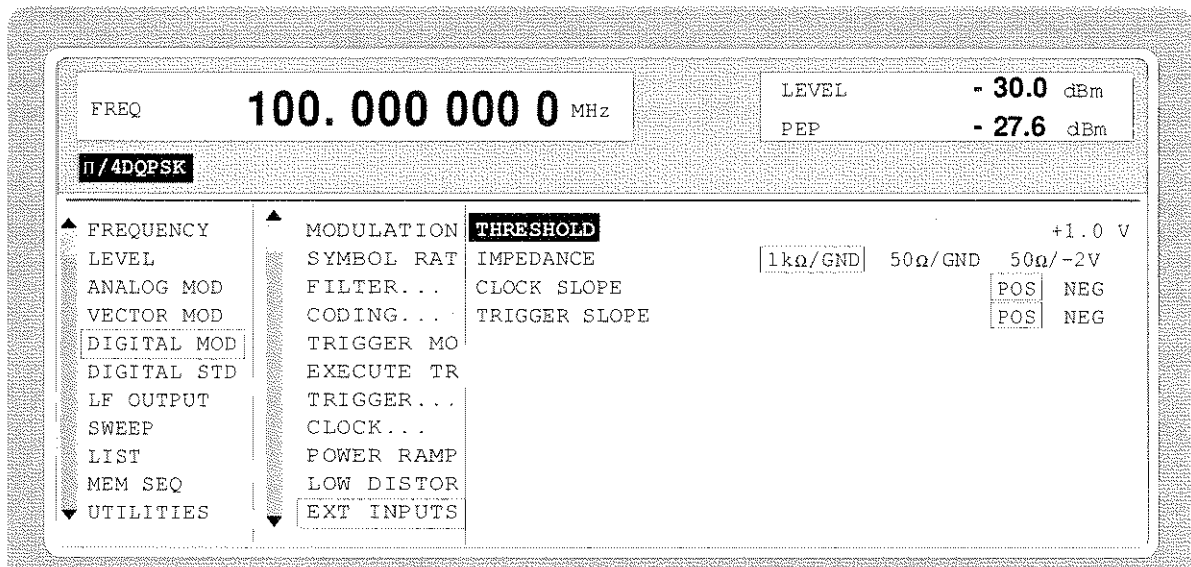

Fig. 2-61 DIGITAL MOD - EXT INPUTS menu, SMIQ equipped with option Modulation Coder SMIQB10 and option Data Generator SMIQB11

(EXT INPUTS...)	TRESHOLD	Input value of high/low threshold in Volt. IEC/IEEE-bus command SOUR:DM:THR 1.0
	IMPEDANCE	Selection of input impedance and reference voltage. 50 Ω/GND should be selected for higher clock rates. Setting 50 Ω/-2V is suitable for sources with ECL output. Make sure to select a suitable setting for the high/low threshold under TRESHOLD. IEC/IEEE-bus command SOUR:DM:INP:IMP G1K
	CLOCK SLOPE	Selection of polarity of active edge of externally fed bit clock or symbol clock. Note: In the internal clock mode, CLOCK SLOPE NEG inverts the clock output signals. IEC/IEEE-bus SOUR:DM:CLOC:POL NORM
	TRIG SLOPE	Selection of polarity of active trigger edge for input TRIGIN. IEC/IEEE-bus SOUR:DM:TRIG:SLOP POS

2.11 Digital Standard PHS

With the options Modulation Coder (SMIQB10) and Data Generator (SMIQB11) provided, modulation signals according to the Japanese PHS standard¹ can be generated. PHS is a TDMA standard for private and public cordless phones.

SMIQ can generate both the transmit signal of a cell station (CS) and the transmit signal of a personal station (PS). Transmission from CS to PS is called "downlink", "uplink" being used for transmission in the opposite direction.

Uplink and downlink are transmitted in the separate time slots of a frame using the time duplex method. Each frame consists of 8 slots. The data contents of each slot can be defined individually by SMIQ by means of a slot editor. SMIQ can generate a control physical slot and also a communication physical slot. Each slot can be switched on or off. A defined intermediate level can also be set.

A burst type has to be defined to configure a slot. The following burst types can be selected:

- TCHFULL simulation of a communication channel for a speech coder rate of 32 kbit/s,
- TCHHALF simulation of a communication channel for a speech coder rate of 16 kbit/s,
- VOX simulation of a communication channel in non-speech intervals with uplink transmission only in every fourth frame,
- SYNC, simulation of a sync channel and
- ALL_DATA burst type for test purposes with freely programmable data contents in the selected slot.

The following internal modulation sources are available:

- different PRBS generators with a sequence length between 2^9-1 and $2^{23}-1$ and
- data lists, ie freely programmable data sequences from the data generator memory.

For generating the PHS signals, SMIQ inserts the modulation data continuously (in real time) into the selected slots. Using a digital signal processor the data generator generates a data sequence with modulation data and control signals for envelope control.

The data generator in SMIQ generates a data stream which is converted into IQ signals in the modulation coder. According to the PHS standard, the modulation type is $\pi/4$ DQPSK at a symbol rate of 192 ksymbol/s and $\sqrt{\text{COS}}$ filtering. Symbol rate and filtering can be changed in SMIQ.

¹ Personal Handy Phone System ARIB Standard (RCR STD-28)

2.11.1 Sync and Trigger Signals

T The data generator generates a data sequence with modulation data, control signals for envelope control, and synchronization signals.

When TRIGGER MODE AUTO is selected, the PHS signal generation automatically starts.

Trigger signals for synchronized sequences can be used for measuring the bit error rate of receivers. A trigger signal can be fed via the TRIGIN input at connector PAR DATA. The active slope of a trigger signal applied there executes a trigger event.

PHS signal generation at a frame limit is started after a trigger event. Data from data lists are inserted into the selected slots starting from the first bit. PRBS generators start with the set initialization status.

Signal generation either starts immediately after the active slope of the trigger signal or after a settable number of symbols (EXT TRIGGER DELAY). Retriggerring (RETRIG) can be inhibited for a settable number of symbols (EXT RETRIGGER INHIBIT).

A trigger event can be executed manually or via the IEC/IEEE bus using EXECUTE TRIGGER.

When a trigger event is executed, a trigger signal is output at the TRIGOUT 3 output of SMIQ.

SMIQ also generates the following sync signals:

- a frame clock at TRIGOUT 1 output,
- a frame or multiframe clock at TRIGOUT 2 output with settable position in the frame,
- the symbol clock and the bit clock.

A clock synthesizer on the modulation coder generates the symbol clock and the bit clock in SMIQ. All the clock signals are synchronized to the 10-MHz reference of SMIQ. The symbol clock is available at connector SYMBOL CLOCK and the bit clock at connector BIT CLOCK. If required, the clock synthesizer in SMIQ can be synchronized to an external symbol or bit clock.

The clock signal is selected in the menu via CLOCK-CLOCK SOURCE EXT.

To allow for a trouble-free synchronization of the clock synthesizer first apply the external clock and set the correct symbol rate at SMIQ. Then switch CLOCK SOURCE from INT to EXT.

Notes: - *The set symbol rate should not differ by more than 1% from the symbol rate of the external signal.*

2.11.2 PN Generators as Internal Data Source

Independent PN generators (Pseudo Noise) can be selected for each slot as data source for data fields DATA and SACCH. These PN generators provide pseudo-random bit sequences of different length or period. That is why they are also called PRBS generators (Pseudo Random Binary Sequence). Data sequences are sequences of maximum length which are generated by means of feedback shift registers.

The following figure gives an example of a 9 bit generator with feedbacks after register 4 and 0 (output).

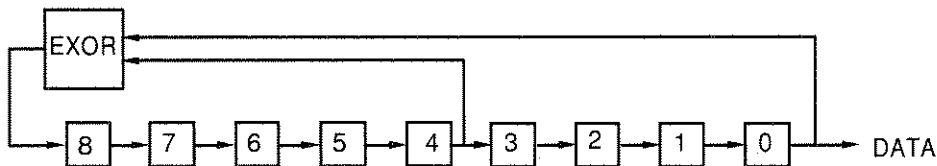

The pseudo-random sequence of a PRBS generator is clearly defined by the number of registers and the feedback. The following table describes all PRBS generators available:

Table 2-13 PRBS generators for PHS

PRBS generator	Length in bits	Feedback after
9 bit	$2^9 - 1 = 511$	Register 4, 0
11 bit	$2^{11} - 1 = 2047$	Register 2, 0
15 bit	$2^{15} - 1 = 32767$	Register 1, 0
16 bit	$2^{16} - 1 = 65535$	Register 5, 3, 2, 0
20 bit	$2^{20} - 1 = 1048575$	Register 3, 0
21 bit	$2^{21} - 1 = 2097151$	Register 2, 0
23 bit	$2^{23} - 1 = 8388607$	Register 5, 0

PN generators PN9,11,15,20 and PN23 are configured according to CCITT Rec. 0.151/152/153. The output sequence is inverted for generators PN15 and PN23.

The start value of the PN generators is different in the slots and equals

$$\text{start value} = 1 + 14 \text{ hex} \times \text{slot number}$$

Example: PN9 generator in slot 1 with start value 15hex = 10101 binary.

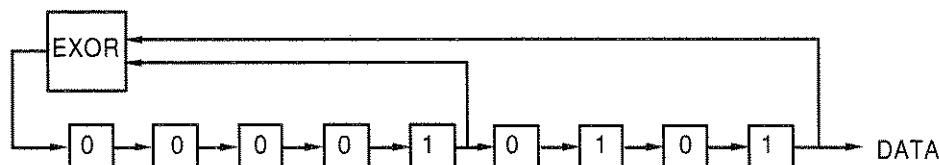

The resulting output sequence is 1010100000010100101011110010 etc.

2.11.3 Lists as Internal Data Source

A freely programmable memory on the data generator serves as internal data source for the data fields of the slots. The data are managed in so-called lists. A list editor allows to select, copy, modify and delete data lists (DATA LIST).

The list editor is available via menu DIGITAL-MOD - SOURCE....

2.11.4 External Modulation Data

External data can (only) be applied via the SERDATA interface. A selection of SERDATA as data source is only possible for a single data field of a slot. For further information on the characteristics of the SERDATA interface see Annex A.

To ensure that the external data bits are assigned to specific positions in the data field of the selected slot and that they are reproducible, the buffer of the RS-232 transmitter and receiver has to be deleted. A triggered start has to follow.

The following setting sequence is required in the DIGITAL STD - PHS menu:

1. Carry out desired settings in menu.
2. Select data source SERDATA for the data field of the slot using SELECT SLOT -
3. Make connection to external data source, but do not yet start external data source.
4. Switch off digital standard using STATE - OFF.
5. Set TRIGGER MODE ARMED_AUTO.
In this state, SMIQ is ready for reception, but discards data that are read in via SERDATA.
6. Switch on digital standard with STATE ON.
7. Start external data source.
The read-in data are written into the receiving buffer. Only if this buffer is filled can SMIQ react to a trigger event.
8. Activate trigger event. Signal generation is thus started at a frame limit. The first bit received via SERDATA is put to the first bit position in the selected data field.

2.11.5 Menu DIGITAL STANDARD - PHS

Menu DIGITAL STD - PHS provides access to settings for generating PHS signals.

Menu selection: DIGITAL STD - PHS

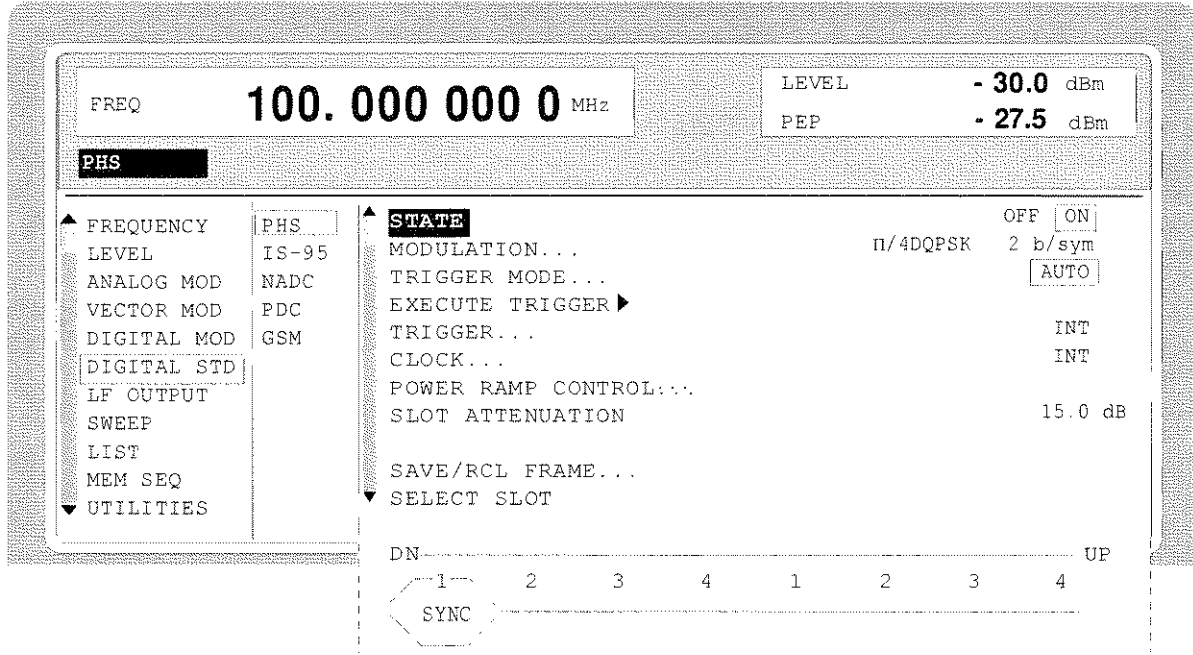

Fig. 2-62 Menu DIGITAL STD - PHS, SMIQ equipped with Modulation Coder SMIQB10 and Data Generator SMIQB11

STATE Switch on/off of Digital Standard PHS modulation. Vector Modulation or Digital Modulation will be switched off automatically.

IEC/IEEE-bus command SOUR:PHS:STAT ON

MODULATION... Opens a window for setting the modulation parameters.

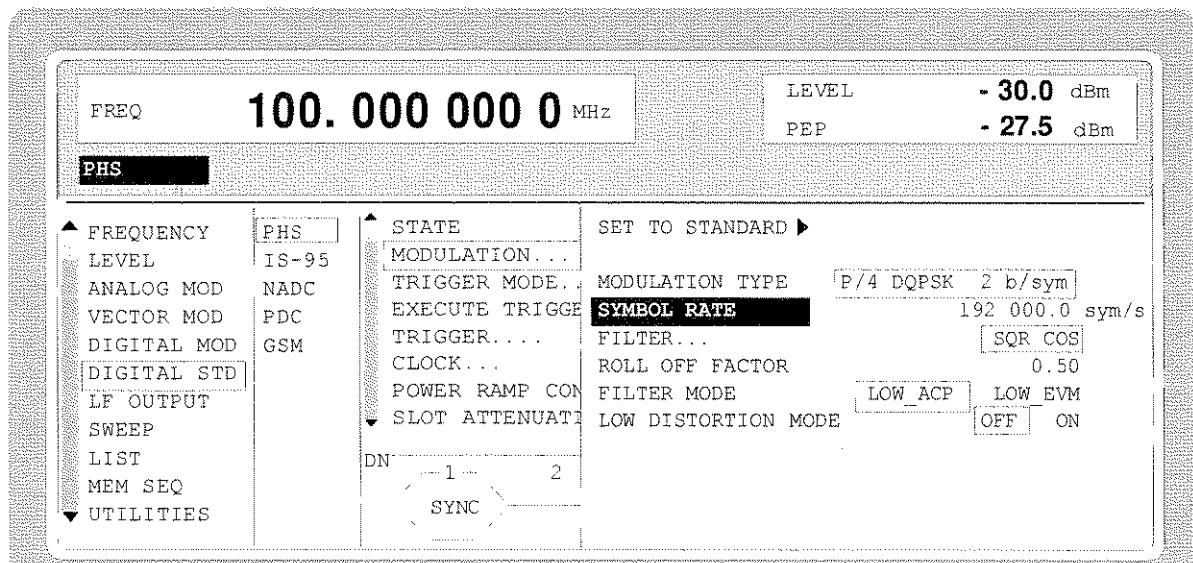

Fig. 2-63 Menu DIGITAL STD - PHS - MODULATION..., SMIQ equipped with Modulation Coder SMIQB10 and Data Generator SMIQB11

(MODULATION...)	SET TO STANDARD ▶	Sets the subsequent modulation parameters to the values predefined by the standard.
	MODULATION TYPE	Displays the modulation type.
	SYMBOL RATE	Input value for the symbol rate. 192 ksymbol/s are preset. IEC/IEEE-bus SOUR:PHS:SRAT 192.01 KHZ
	FILTER	Selection of baseband filter. A selection between Nyquist filters COS and SQRCOS is possible. IEC/IEEE-bus SOUR:PHS:FILT:TYPE COS
	ROLL OFF FACTOR	Input value for the roll-off factor. IEC/IEEE-bus SOUR:PHS:FILT:PAR 0.50
	FILTER MODE	Selection of filter mode. LOW_ACP Filter for minimum <u>A</u> djacent <u>C</u> hannel <u>P</u> ower. IEEE SOUR:PHS:FILT:MODE LACP LOW_EVM Filter for minimum vector error. IEEE SOUR:PHS:FILT:MODE LEVM
	LOW DISTORTION	Switch on/off of low-distortion mode.. After switch-on, the level of the IQ baseband signals is reduced by 3 dB. In some cases, this might reduce undesired intermodulation products. OFF is normally the more favourable setting. IEC/IEEE-bus command SOUR:PHS:LDIS OFF
TRIGGER MODE...	Opens a window for selecting the trigger mode.	
	AUTO	The PHS signals are continuously transmitted in the activated slots. IEC/IEEE-bus command SOUR:PHS:SEQ AUTO
	RETRIG	The PHS signals are continuously transmitted in the activated slots. A trigger event causes a restart. IEC/IEEE-bus command SOUR:PHS:SEQ RETR
	ARMED_AUTO	The PHS signal generation does not start until a trigger event has occurred. The unit then automatically switches over to the AUTO mode and can no longer be triggered. IEC/IEEE-bus command SOUR:PHS:SEQ AAUT
	ARMED_RETRIG	The PHS signal generation does not start until a trigger event has occurred. The unit then automatically switches over to the RETRIG mode. Each new trigger event causes a restart. IEC/IEEE-bus command SOUR:PHS:SEQ ARET
	EXECUTE TRIGGER ▶	Executes a trigger even to start the PHS signal generation. IEC/IEEE-bus command : TRIG:DM IMM

TRIGGER... Opens a window for selecting the trigger source, for configuring the trigger output signals and for setting the time delay of an external trigger signal.

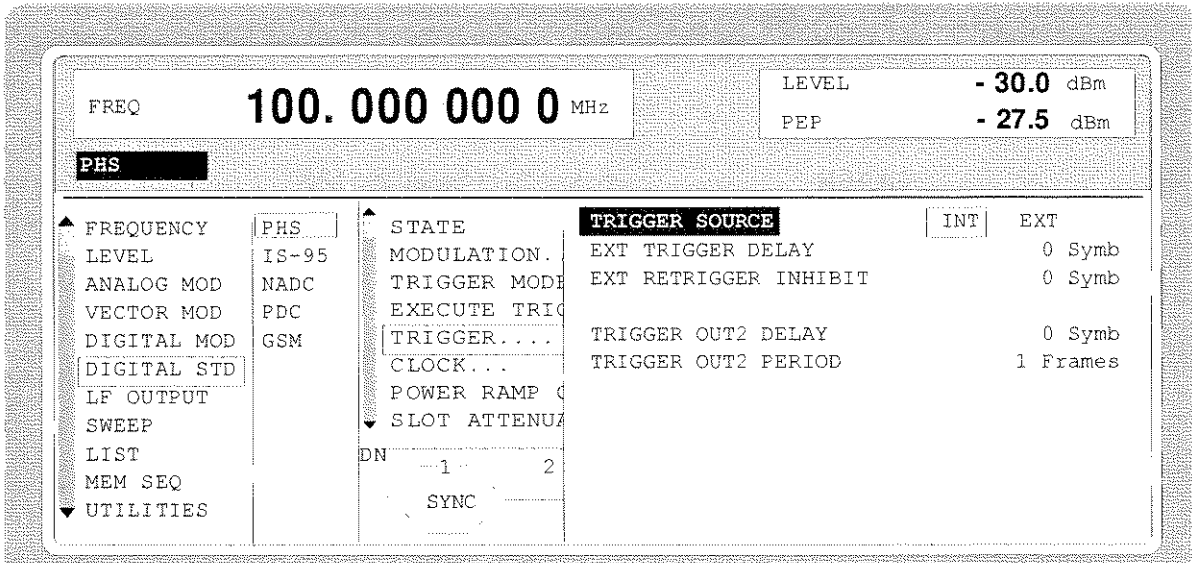

Fig. 2-64 Menu DIGITAL STD - PHS_TRIGGER..., SMIQ equipped with Modulation Coder SMIQB10 and Data Generator SMIQB11

(TRIGGER...)	TRIGGER SOURCE	Selection of trigger source.
		EXT The PHS signal generation is started by the active slope of an external trigger signal. The polarity, the trigger threshold and the input resistance of the TRIGIN input can be modified in menu DIGITAL MOD - EXT INPUTS.
		INT A trigger event can be executed by EXECUTE TRIGGER ►.
		IEC/IEEE-bus SOUR:PHS:TRIG:SOUR EXT
	EXT TRIGGER DELAY	Setting the number of symbols by which an external trigger signal is delayed before it starts the PHS signal generation. This is used for setting the time synchronization between the the SMIQ and the DUT. IEC/IEEE-bus command SOUR:PHS:TRIG:DEL 3

(TRIGGER...)

**EXT RETRIGGER
INHIBIT**

Setting the number of symbols for which a restart is inhibited after a trigger event.
With TRIGGER MODE RETRIG selected, each new trigger signal restarts the PHS signal generation. This restart can be inhibited for the entered number of symbols.

Example:

The entry of 1000 symbols causes new trigger signals to be ignored for the duration of 1000 symbols after a trigger event

IEC/IEEE-bus SOUR:PHS:TRIG:INH 1000

**TRIGGER OUT 2
DELAY**

Input value of delay of trigger signal at TRIGOUT 2 output compared with beginning of frame.

IEC/IEEE-bus SOUR:PHS:TRIG:OUTP:DEL 2

**TRIGGER OUT2
PERIOD**

Input value of output signal period at TRIGOUT 2 output given in frames.

IEC/IEEE-bus SOUR:PHS:TRIG:OUTP:PER 1

CLOCK... Opens a window for selecting the clock source and for setting a delay.

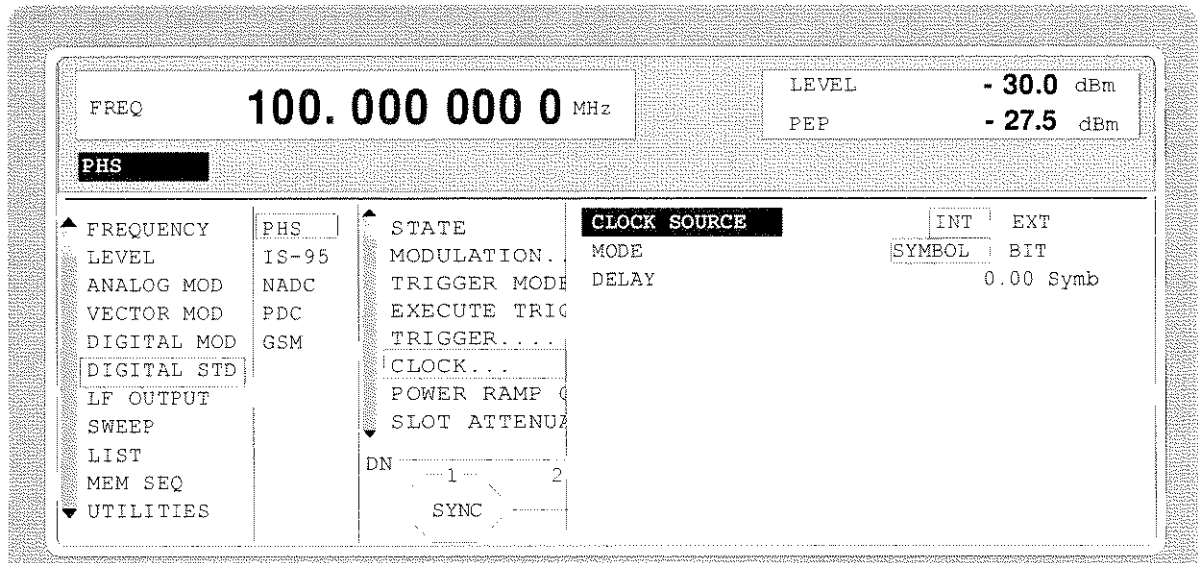

Fig. 2-65 Menu DIGITAL STD - PHS - CLOCK..., SMIQ equipped with Modulation Coder SMIQB10 and Data Generator SMIQB11

(CLOCK...)	CLOCK SOURCE	<p>Selection of clock source.</p> <p>INT SMIQ uses internally generated clock signals.</p> <p>EXT An external symbol clock or bit clock is fed in at connectors SYMBOL CLOCK or BIT CLOCK. The clock synthesizer on the modulation coder is synchronized to this clock. The symbol rate has to be set with an accuracy of $\pm 1\%$. The polarity, the trigger threshold and the input resistance of the clock inputs can be modified in menu DIGITAL MOD - EXT INPUTS.</p> <p>IEC/IEEE-bus command SOUR:PHS:CLOC:SOUR INT</p>
	MODE	<p>Selection of clock for external clock signal.</p> <p>SYMBOL The external clock has to be a symbol clock.</p> <p>BIT The external clock has to be a bit clock.</p> <p>IEC/IEEE-bus command SOUR:PHS:CLOC:MODE SYMB</p>
	DELAY	<p>Setting the delay of generated modulation signal to an external clock. This can be used, for example, for synchronization with a second unit to achieve time synchronization between the modulation signals of the two units.</p> <p>IEC/IEEE-bus command SOUR:PHS:CLOC:DEL 0.5</p>

POWER RAMP CONTROL...

Opens a window for setting the envelope control, especially for the rising and falling ramp at the beginning and end of a slot.

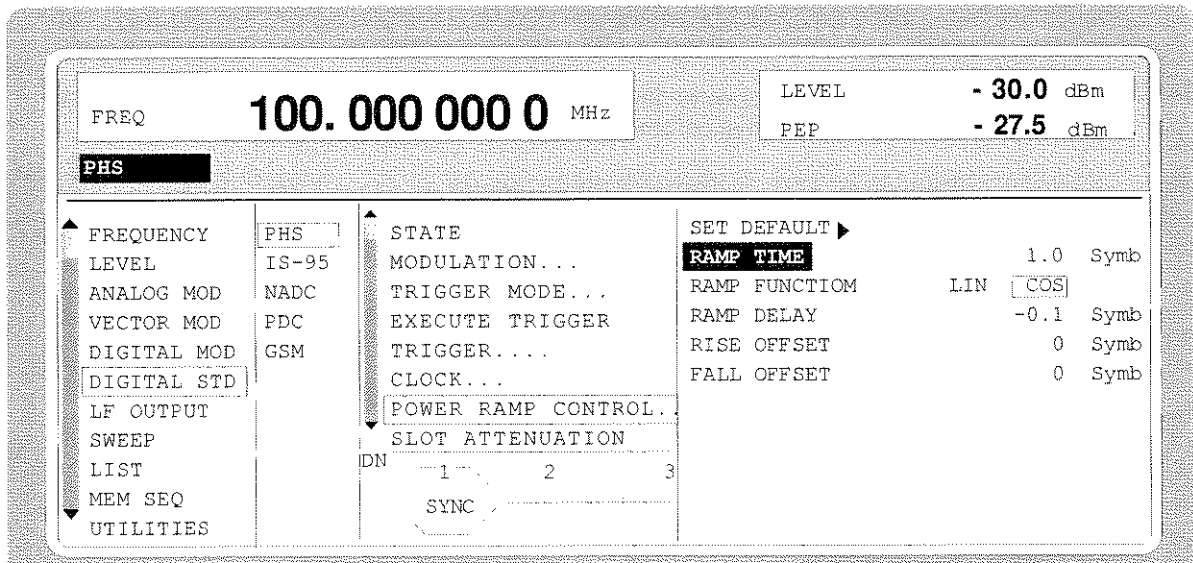

Fig. 2-66 Menu DIGITAL STD - PHS - POWER RAMP CONTROL... , SMIQ equipped with Modulation Coder SMIQB10 and Data Generator SMIQB11

(POWER RAMP CONTROL...)

SET DEFAULT ►

Resets the subsequent parameters to the factory-set values.

IEC/IEEE-bus : SOUR:PHS:PRAM:PRES

RAMP TIME

Input value for the rise and fall time of the envelope at the beginning or end of a slot. The time is set in units of symbol period.

IEC/IEEE-bus SOUR:PHS:PRAM:TIME 0.25

RAMP FUNCTION

Selection of shape of rising and falling ramp for envelope control.

LIN Linear ramp function.

COS Cosine function. A more favourable spectrum than that of the LIN function is obtained.

IEC/IEEE-bus SOUR:PHS:PRAM:SHAP LIN

RAMP DELAY

Input value for a shift of the envelope characteristic to the modulated signal. A positive value causes a delay of the envelope. The values are set in the units of the symbol length.

IEC/IEEE-bus SOUR:PHS:PRAM:DEL 0.1

RISE OFFSET

Input value for a positive or negative offset of the rising ramp of the envelope at the beginning of a slot.

IEC/IEEE-bus SOUR:PHS:PRAM:ROFF -1

FALL OFFSET

Input value for a positive or negative offset of the falling ramp of the envelope at the end of a slot.

IEC/IEEE-bus SOUR:PHS:PRAM:FOFF 1

SLOT ATTENUATION Input value for the level reduction in dB of all active slots whose SLOT LEVEL was set to ATTEN. Menu SELECT SLOT allows the slots to be determined whose level is to be reduced.

IEC/IEEE-bus command `SOUR:PHS:SLOT:ATT 40 DB`

SAVE/RCL FRAME... Opens a window for saving and loading a frame configuration. Loading a frame affects all parameters that can be set under SELECT SLOT.

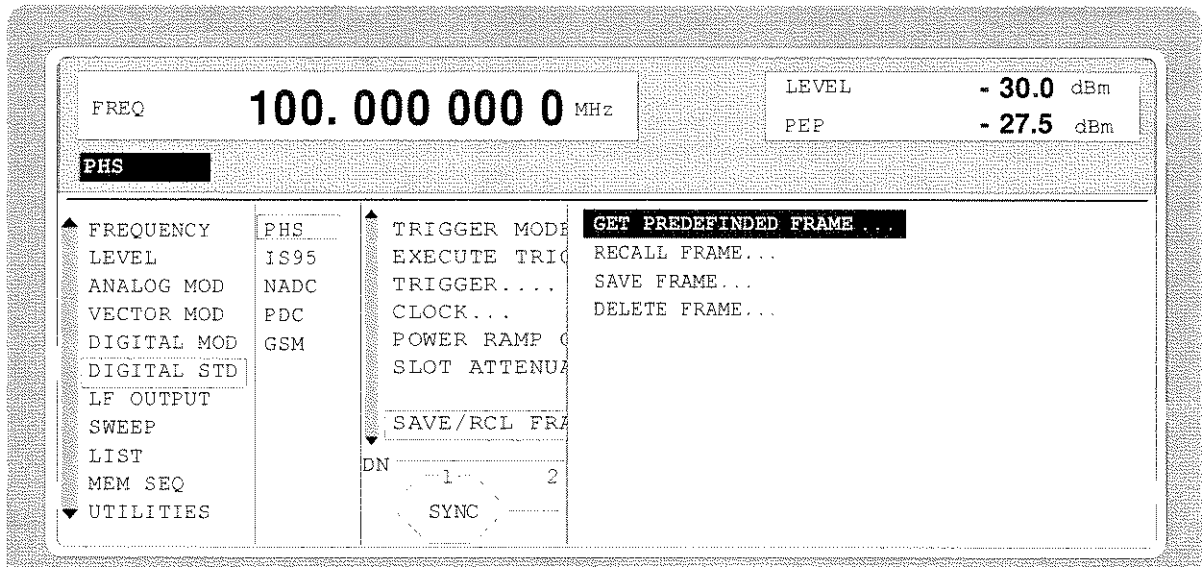

Fig. 2-67 Menu DIGITAL STD - PHS - SAVE/RCL FRAME, SMIQ equipped with Modulation Coder SMIQB10 and Data Generator SMIQB11

- (SAVE/RCL FRAME...) GET PREDEFINED FRAME...** Loads a factory-set frame configuration.
 DN1_TCH Downlink Traffic Channel in slot1
 UP1_TCH Uplink Traffic Channel in slot1
 DN1_SYNC Downlink Sync Channel in slot1
 IEEE `SOUR:PHS:FLIS:PRED:LOAD "DN1_TCH"`
- RECALL FRAME...** Loads a frame configuration saved by the user.
 IEC/IEEE-bus `SOUR:PHS:FLIS:LOAD "name"`
- SAVE FRAME...** Saves a user-defined frame configuration.
 IEC/IEEE-bus `SOUR:PHS:FLIS:STOR "name"`
- DELETE FRAME...** Deletes a frame configuration saved by the user.
 IEC/IEEE-bus `SOUR:PHS:FLIS:DEL "name"`

SELECT SLOT...

Selection of one of 8 possible slots. When selecting the slot, a window is opened in which the data contents belonging to this slot can be defined. 4 slots are available for uplink and downlink. They are designated as UP<i> and DN<i> in the display. For remote control, the slots are numbered from 1 to 8. The following assignment applies:

Slot	DN1	DN2	DN3	DN4	UP1	UP2	UP3	UP4
Slot number	1	2	3	4	5	6	7	8

Note: If the cursor is placed onto a slot in the diagram, it may be switched on and off by pressing one of the unit keys (toggle function).

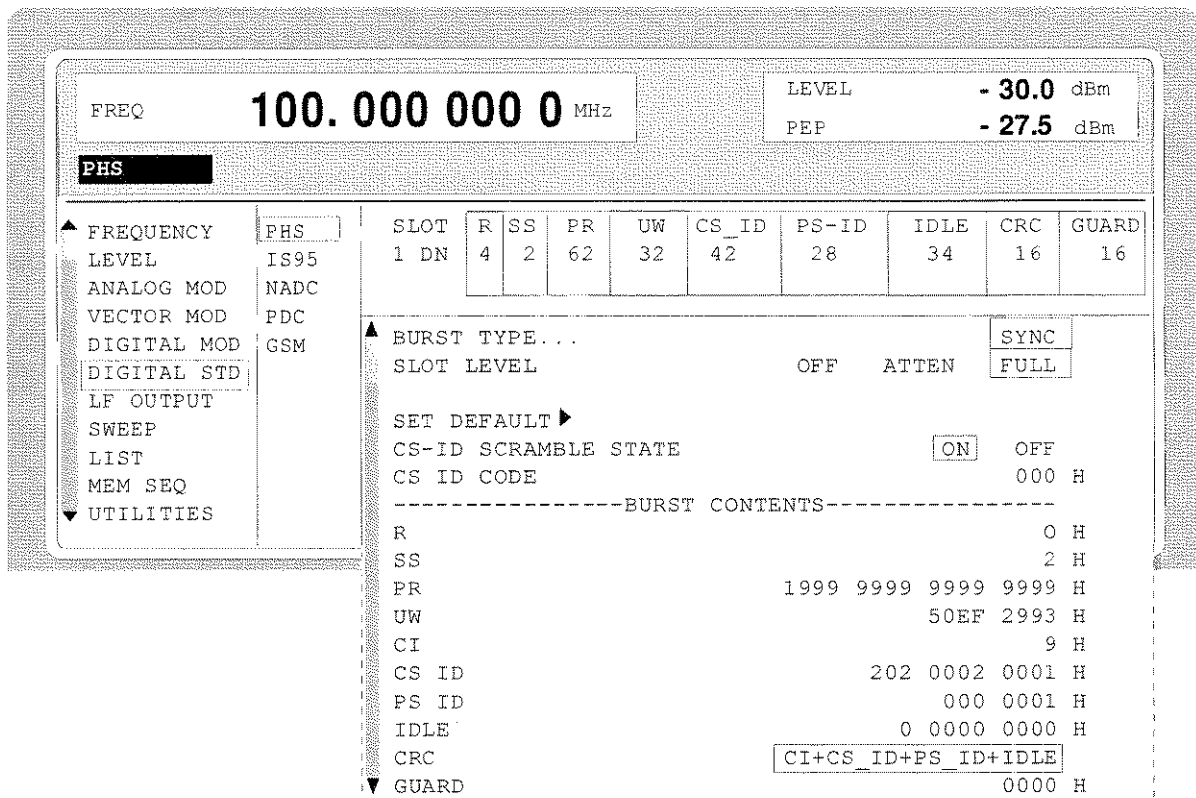

Fig. 2-68 Menu DIGITAL STD - PHS - SELECT SLOT, SMIQ equipped with Modulation Coder SMIQB10 and Data Generator SMIQB11

(SELECT SLOT)	BURST TYPE...	<p>Opens a window for the selection of the burst type used to configure the selected slot.</p> <p>TCH_FULL Traffic channel configuration (rate 32 kbit/s) IEEE-bus SOUR:PHS:SLOT2:TYPE TCHF</p> <p>TCH_HALF Traffic channel configuration (rate 16 kbit/s) IEEE-bus SOUR:PHS:SLOT2:TYPE TCHH</p> <p>VOX VOX configuration. In slots 4 to 8 (uplink) transmission is only in every fourth frame. IEEE-bus SOUR:PHS:SLOT2:TYPE VOX</p> <p>SYNC Sync burst IEEE-bus SOUR:PHS:SLOT2:TYPE SYNC</p> <p>ALL DATA Burst type for testing with freely programmable data contents IEEE-bus SOUR:PHS:SLOT2:TYPE ADAT</p>
	SLOT LEVEL	<p>Selection of level for selected slot.</p> <p>OFF Maximum attenuation IEEE bus : SOUR:PHS:SLOT2:LEV OFF</p> <p>FULL The level corresponds to the value indicated on the SMIQ LEVEL display. IEEE bus : SOUR:PHS:SLOT2:LEV FULL</p> <p>ATTEN The level is reduced by the value set under SLOT ATTENUATION. IEEE bus : SOUR:PHS:SLOT2:LEV ATT</p>
	SET DEFAULT ►	<p>Resets the subsequent parameters to the factory-set values. IEC/IEEE-bus command SOUR:PHS:SLOT8:PRES</p>
	CS-ID SCRAMBLE STATE	<p>Switch on/off of CS-ID scrambling function. IEC/IEEE-bus SOUR:PHS:SLOT2:SCR:STAT ON</p>
	CS-ID SRAMBLE CODE	<p>Input value in hexadecimal form for initializing the scramble generator. IEEE-bus SOUR:PHS:SLOT2:SCR:CODE #H123</p>
	ENCRYPTION STATE	<p>Switch on/off of encryption scrambling function. This parameter is only available for TCH burst types. IEC/IEEE-bus SOUR:PHS:SLOT2:ENCR:STAT ON</p>
	ENCRYPTION KEY	<p>Input value in hexadecimal form for initializing the scramble generator. This parameter is only available for TCHburst types. IEEE-bus SOUR:PHS:SLOT2:ENCR:KEY #H1234</p>
	R	<p>Display of data contents in the 4-bit data field "Ramp".</p>
	SS	<p>Display of data contents in the 2-bit data field "Start Symbol".</p>

(SELECT SLOT)	PR	Display of "Preamble".
	UW	Input value for the "Unique Word" in hexadecimal form. IEC/IEEE-bus SOUR:PHS:SLOT2:UWOR #H3D4C
	CI	Display of the "Channel Identifier" data field in hexadecimal form.
	SA	Selection of data source for SACCH. This data field is only displayed for burst types TCH and VOX. PN.. PRBS data according to CCITT V52 or Rec. 0.151 with periods between 2^9-1 and $2^{23}-1$. IEEE :SOUR:PHS:SLOT3:SACCH PN9 DLIST Data from a programmable data list. IEEE :SOUR:PHS:SLOT3:SACCH DLIS SERDATA Data from data input SER DATA IEEE :SOUR:PHS:SLOT3:SACCH SDAT
	TCH / VOX	Selection of data source for TCH data field. This data field is only displayed for burst types TCH and VOX. PN.. PRBS data according to CCITT V52 or Rec. 0.151 with periods between 2^9-1 and $2^{23}-1$. IEEE :SOUR:PHS:SLOT3:TCH PN9 DLIST Data from a programmable data list. IEEE :SOUR:PHS:SLOT3:TCH DLIS SERDATA Data from data input SER DATA IEEE :SOUR:PHS:SLOT3:TCH SDAT
	CS-ID	Input value for the "Cell Station ID Code" field in hexadecimal form. This data field is only displayed for the burst type SYNC. IEEE-bus SOUR:PHS:SLOT2:CSID #H20200020001
	PS-ID	Input value for the "Personal Station ID Code" field in hexadecimal form. This data field is only displayed for the burst type SYNC. IEEE-bus SOUR:PHS:SLOT2:PSID #H00000001
	IDLE	Display of data contents in the "Idle" field. This field is only displayed for the burst type SYNC.
	G	Display of data contents in the "Guard" field in hexadecimal form.

2.12 Digital Standard IS-95 CDMA

With the options Modulation Coder (SMIQB10), Data Generator (SMIQB11) and option Digital Standard CDMA (SMIQB42) provided, CDMA signals can be generated according to standard IS-95¹ as well as J-STD-008.

SMIQ can simulate both the transmit signal of a base station (forward link) and the transmit signal of a mobile station (reverse link). The forward link signal consists of up to 64 code channels. A reverse link signal can be generated in the full-rate or half-rate mode.

Simple bit patterns or pseudo random bit sequences (PRBS) can be selected as modulation data for forward link. Every code channel has a different PRBS. Modulation data are not subject to channel coding (convolution coding, interleaving).

The following figure shows the schematic of forward link signal generation.

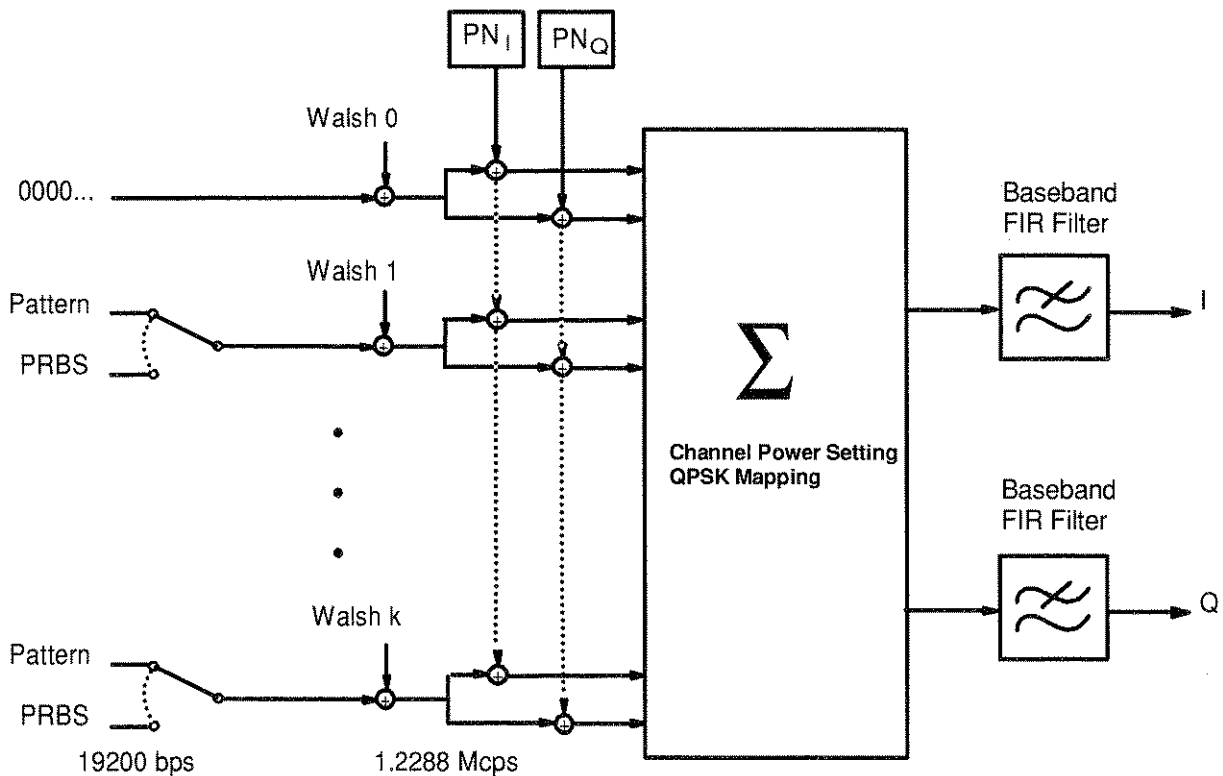

Fig. 2-69 Forward link signal generation

At a chip rate of 1.2288 Mcps, the modulation data rate for forward link is 19200 bp/s for all channels. The modulation type is QPSK. For baseband filtering, a FIR filter with equalizer is preset according to IS-95 (FILTER TYPE IS-95 EQUAL). Other filters can be set as well. The chip rate is preset to 1.2288 Mcps according to IS-95 but can be freely selected.

¹ TIA/EIA/IS-95, Mobile Station-Base Station Compatibility Standard for Dual-Mode Wideband Spread Spectrum Cellular Systems

To generate a reverse link signal, two different operating modes are available. The following figure shows the schematic of reverse link signal generation without channel coding.

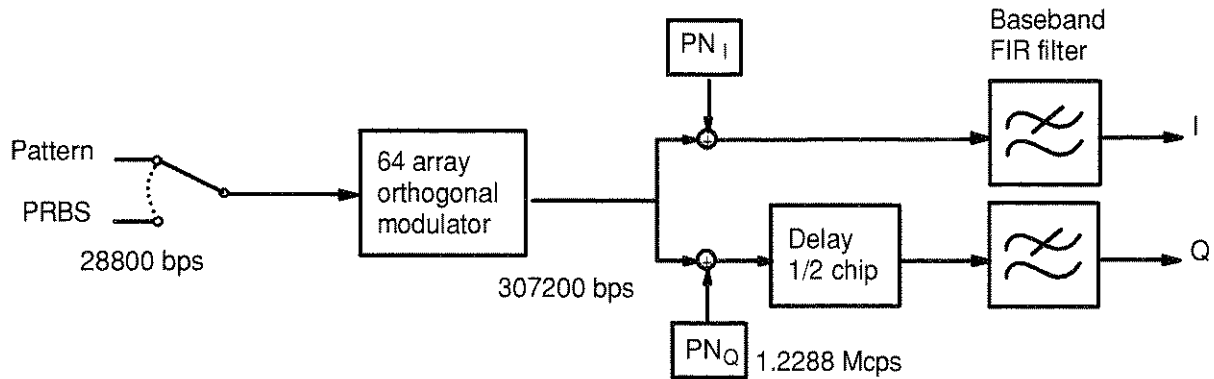

Fig. 2-70 Reverse link signal generation without channel coding

Simple bit patterns, PRBS and freely programmable data sequences in a data list are available as modulation data. At a chip rate of 1.2288 MHz, the modulation data rate of the reverse link is 28800 bps/s. The modulation type is offset-QPSK. A FIR filter is preset as baseband filter without equalizer according to IS-95 (FILTER TYPE IS-95).

The second reverse link mode also comprises channel coding. With this reverse link coded mode, both an access channel (4800 bps) and a traffic channel can be generated with all the data rates between 1200 bps and max. 14400 bps complying with IS-95 (Rate Set 1 and 2). The following figure gives an example of signal generation for the traffic channel with 9600 bps and shows the associated frame structure.

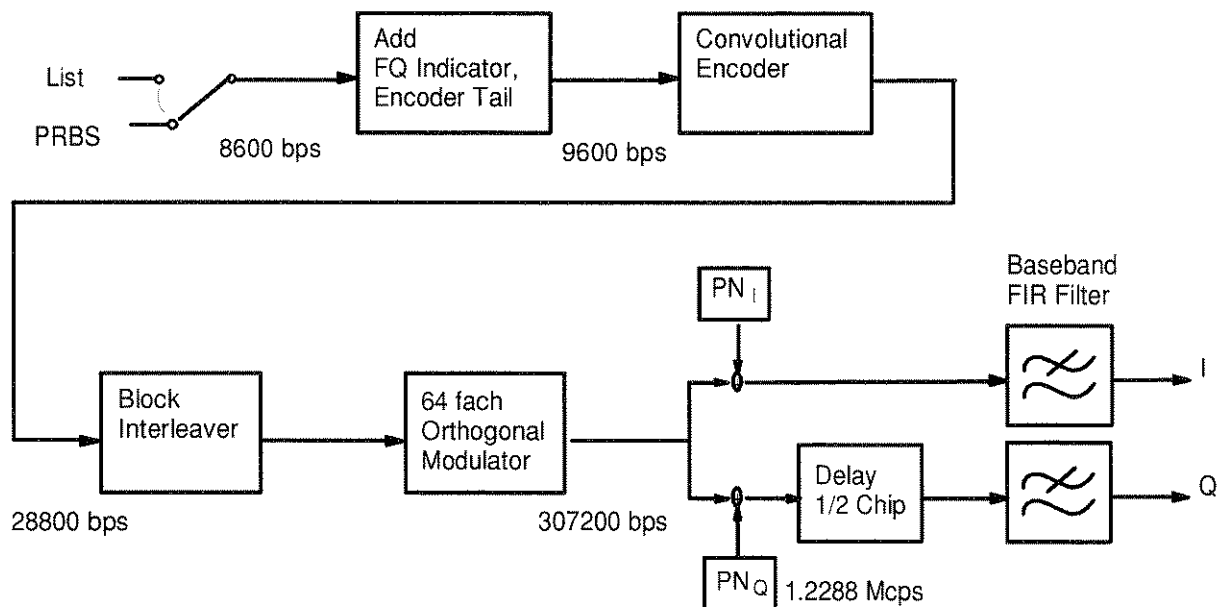

Fig 2-71 Traffic channel 9600 in "Reverse Link Coded" mode

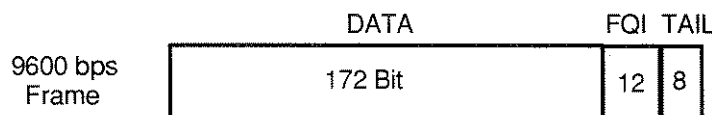

Fig 2-72 Frame structure of traffic channel 9600 in "Reverse Link Coded" mode

PRBS of different lengths and a list of freely programmable data sequences are available as modulation data. In the reverse link coded mode, MIQ generates a test signal for BER and FER measurements at a base station receiver. A special service mode is required for the DUT since the long code is set to 0 in the SMIQ test signal.

To facilitate operation, the following tables show the frequency channels according to regulations IS-95 and J-STD-008. The tables are also available on the SMIQ display via the HELP function for IS-95 menu selection.

Table 2-14 CDMA: channel numbers and their frequencies

IS-95	channel numbers	generator frequency /MHz
Mobile station	$1 \leq N \leq 777$	$0.03N + 825.0$
	$1013 \leq N \leq 1023$	$0.03(N-1023)+825.0$
Base station	$1 \leq N \leq 777$	$0.03N + 870.0$
	$1013 \leq N \leq 1023$	$0.03(N-1023)+870.0$

J-STD-008	channel number	generator frequency/MHz
Mobile station	$1 \leq N \leq 1199$	$0.050N + 1850.000$
Base station	$1 \leq N \leq 1199$	$0.050N + 1930.000$

Table 2-15 Preferred CDMA-frequency channels according to J-STD-008

channel number	generator-frequency/MHz		channel number	generator-frequency/MHz	
	mobile station	base station		mobile station	base station
25	1851.25	1931.25	600	1880.00	1960.00
50	1852.50	1932.50	625	1881.25	1961.25
75	1853.75	1933.75	650	1882.50	1962.50
100	1855.00	1935.00	675	1883.75	1963.75
125	1856.25	1936.25	725	1886.25	1966.25
150	1857.50	1937.50	750	1887.50	1967.50
175	1858.75	1938.75	775	1888.75	1968.75
200	1860.00	1940.00	825	1891.25	1971.25
225	1861.25	1941.25	850	1892.50	1972.50
250	1862.50	1942.50	875	1893.75	1973.75
275	1863.75	1943.75	925	1896.25	1976.25
325	1866.25	1946.25	950	1897.50	1977.50
350	1867.50	1947.50	975	1898.75	1978.75
375	1868.75	1948.75	1000	1900.00	1980.00
425	1871.25	1951.25	1025	1901.25	1981.25
450	1872.50	1952.50	1050	1902.50	1982.50
475	1873.75	1953.75	1075	1903.75	1983.75
500	1875.00	1955.00	1100	1905.00	1985.00
525	1876.25	1956.25	1125	1906.25	1986.25
550	1877.50	1957.50	1150	1907.50	1997.50
575	1878.75	1958.75	1175	1908.75	1988.75

2.12.1 Sync and Trigger Signals

A CDMA sequence with a length of 98304 chips is calculated for the generation of forward link CDMA signals and stored in the memory of the data generator (option SMIQB11). This chip sequence can be run repetitively (TRIGGER MODE AUTO). During reverse link signal generation with channel coding, the modulation data are continuously processed in real time.

Trigger signals can be used for synchronized measurements on receivers.

A trigger signal can be fed via the TRIGIN input at connector PAR DATA. The chip sequence either starts immediately after the active slope of the trigger signal or after a settable number of chips (TRIGGER DELAY). Retriggering (RETRIG) can be inhibited for a settable number of chips (TRIGGER INHIBIT).

A trigger event can be executed manually or via the IEC/IEEE bus using EXECUTE TRIGGER. When a trigger event is executed, a trigger signal is output at the TRIGOUT 3 output of SMIQ.

SMIQ also generates the following sync signals:

- a 20-ms frame clock (traffic channel frame clock)
- a 80/3-ms clock (short sequence rollover)
- a 80-ms clock (super frame clock)
- a 2-s clock (even second clock)
- a PCG clock in reverse link at half rate, 1/4 rate and 1/8 rate

SMIQ can output two of the four signals via pins TRIGOUT 1 and 2 of connector PAR DATA.

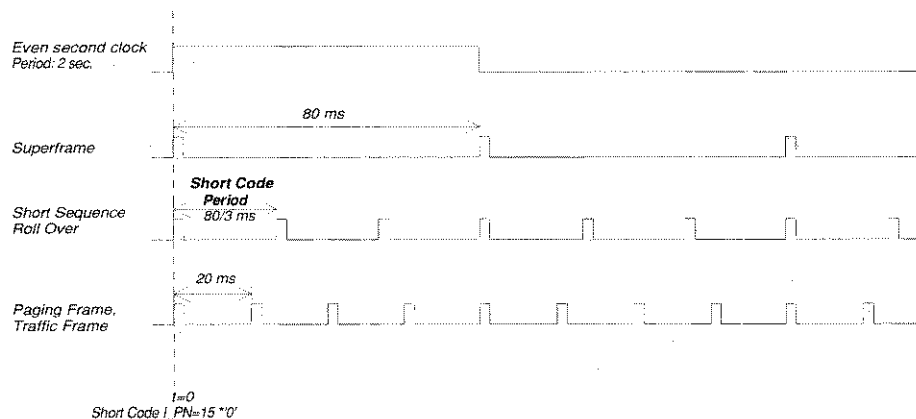

Fig. 2-73 CDMA sync signals

A clock synthesizer on the modulation coder generates the chip clock and a multifold chip clock in the SMIQ. All the clock signals are synchronized to the 10-MHz reference of the SMIQ. The chip clock is available at connector SYMBOL CLOCK and the multifold chip clock at connector BIT CLOCK. If required, the clock synthesizer in the SMIQ can be synchronized to an external chip clock which is fed in at connector SYMBOL CLOCK.

The clock signal is selected in the menu via CLOCK-CLOCK SOURCE EXT.

To allow for a trouble-free synchronization of the clock synthesizer first apply the external clock and set the correct symbol rate at SMIQ. Then switch CLOCK SOURCE from INT to EXT.

Note: The set symbol rate should not differ by more than 1% from the symbol rate of the external signal.

2.12.2 PRBS Data Source in Forward Link

A PN generator is used as PRBS data source for forward link modes. This PN generator provides a pseudo random bit sequence with a period of $2^{17}-1$. The PRBS data sequence is a so-called sequence of maximum length that is generated by means of a feedback shift register. The following schematic shows the PN generator with feedback to registers 3 and 0 (output). The data of the start value are entered into the register.

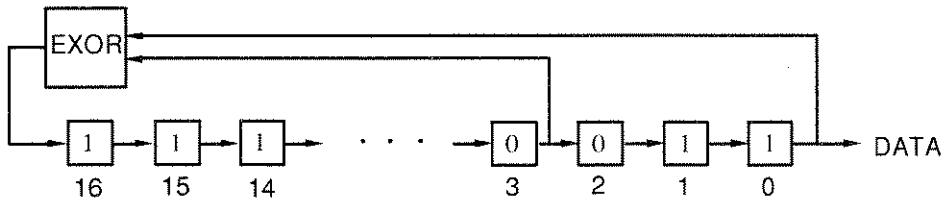

The start value of the PN generator is 1100 0100 1110 0011 1

The bit sequence after the start thus is:

```

    1100 0100 1110 0011 1111 0001 1111 1110...
... 0011 1111 0000 0111 1110 0011 1001 1100...
... 0111 1111 1011 1111 1100 0001 0010 0000...
... 1110 0100 0001 0011 1110 0010 0100 0110.....
    
```

The generated bits are assigned to the modulation data of the different forward link modes as follows:

Mode FWD_LINK_18

The PN bits are assigned to the different code channels as follows:

Modulation data bit 0:

```

    1100 0100 1110 0011 1111 0001 1111 1110 ...
    ↑                               ↑
    c31, ch30, .....ch0 ...
    
```

Modulation data bit 1:

```

    0011 1111 0000 0111 1110 0011 1001 1100 ...
    ↑                               ↑
    ch31, ch30, .....ch0 ...
    
```

etc.

The data bits of the unused code channels c18 to c31 and those of the deactivated code channels are discarded, ie not used.

Modus FWD_LINK_64

The PN bits are assigned to the different code channels as follows:

Modulation data bit 0:

```

    11000100111000111111000111111110 00111111000001111110001110011100 ...
    ↑                               ↑ ↑                               ↑
    c31, ch30, .....ch0, ch63, ch62, .....ch32 ...
    
```

Modulation data bit 1:

```

    0111111101111111100000100100000.11100100000100111110001001000110 ...
    ↑                               ↑ ↑                               ↑
    c31, ch30, .....ch0, ch63, ch62, .....ch32 ...
    
```

etc.

The data bits of the deactivated code channels are discarded, ie not used.

2.12.3 PN Generators as Internal Data Source for Reverse Link

Different PN(Pseudo Noise) generators can be selected as data source for modulation data in the two reverse link modes. These PN generators provide pseudo random bit sequences of different lengths or periods which is why they are also called PRBS generators (Pseudo Random Binary Sequence). The data sequences are so-called sequences of maximum lengths that are generated by means of feedback shift registers.

The following schematic shows the 9 bit generator with feedback to registers 4 and 0 (output).

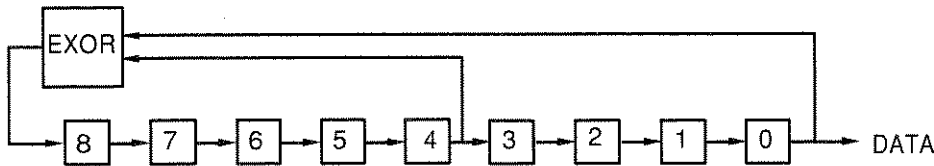

The pseudo random sequence of a PRBS generator is determined by the number of registers and the feedback. The following table describes all available PRBS generators:

Table 2-16 PN generators for IS-95 reverse link

PRBS generator	Length in bits	Feedback to	Start value
9 bits	$2^9 - 1 = 511$	Register 4, 0	1100 0100 1
11 bits	$2^{11} - 1 = 2047$	Register 2, 0	1100 0100 111
15 bits	$2^{15} - 1 = 32767$	Register 1, 0	1100 0100 1110 001
16 bits	$2^{16} - 1 = 65535$	Register 5, 3, 2, 0	1100 0100 1110 0011
20 bits	$2^{20} - 1 = 1048575$	Register 3, 0	1100 0100 1110 0011 1111
21 bits	$2^{21} - 1 = 2097151$	Register 2, 0	1100 0100 1110 0011 1111 0
23 bits	$2^{23} - 1 = 8388607$	Register 5, 0	1100 0100 1110 0011 1111 000

PN generators PN9,11,15,20 and PN23 are designed according to CCITT Rec. 0.151/152/153. The output sequence is inverted for generators PN15 and PN23.

Example: PN9 generator in slot 1 with start value 110001001 (binary)

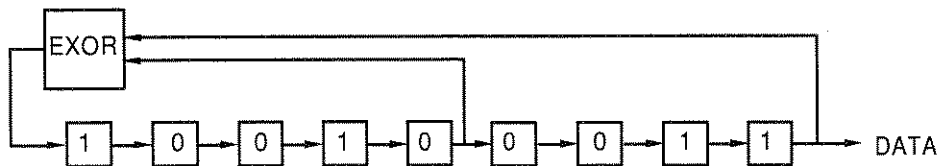

The resulting output sequence is 110001001100010001000 etc.

2.12.4 Menu CDMA Standard - Forward Link Signal

Menu DIGITAL STD - IS-95 provides access to settings for IS-95 CDMA signal generation. The following figure shows the menu for generating the forward link signal (transmit signal of base station) in the FWD_LINK_18 mode. The menus for generating reverse link signals are described in the following section. Parameters that are identical for both modes are explained in the menu for forward link.

Menu selection: DIGITAL STD - IS-95- MODE - FWD_LINK_18

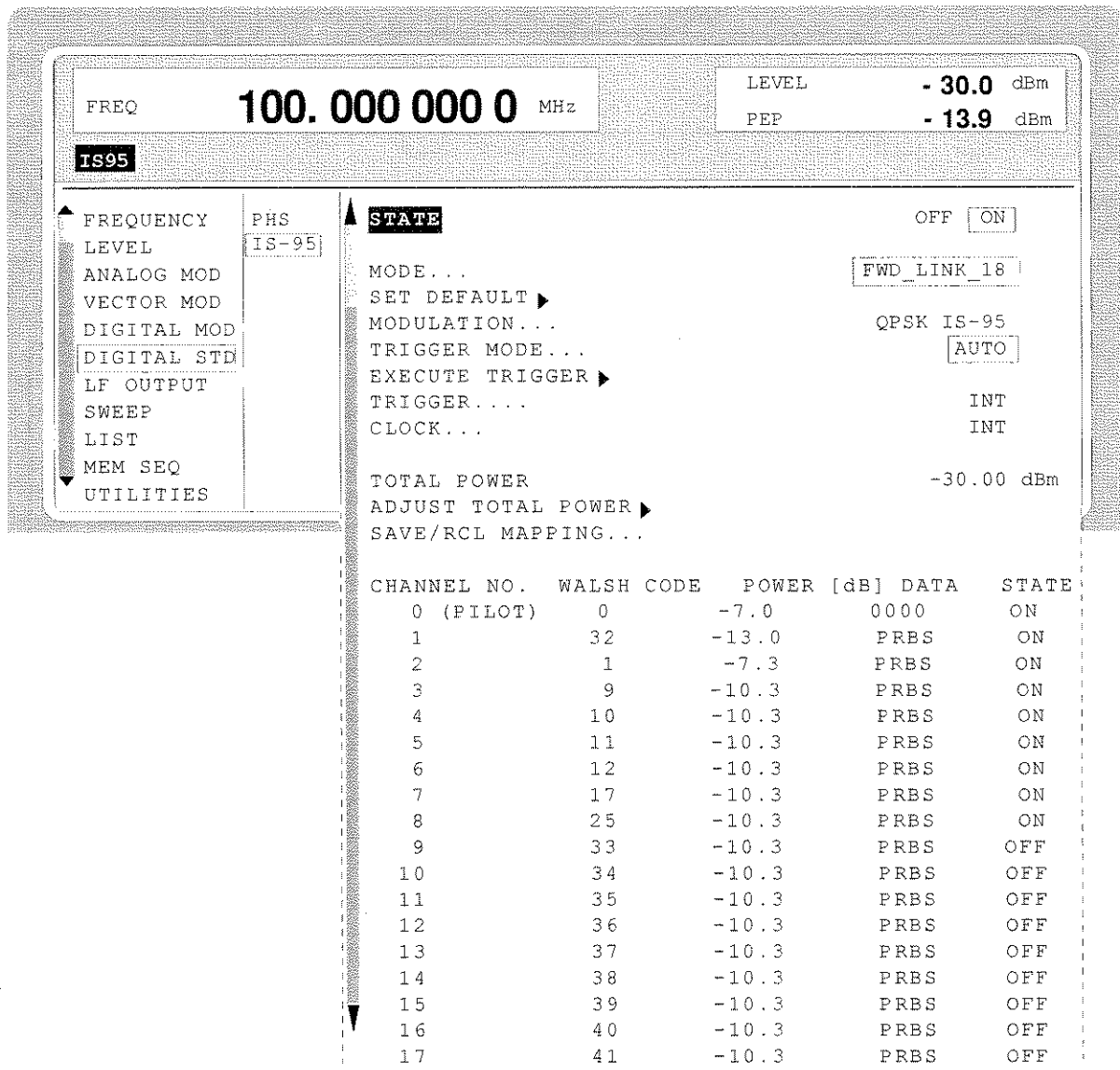

Fig. 2-74 Menu DIGITAL STD - IS-95 - MODE - FWD_LINK_18

STATE

Switch on/off of modulation Digital Standard IS-95 CDMA. Vector modulation and digital modulation will be switched off automatically.

IEC/IEEE-bus command SOUR:IS95:STAT ON

MODE	Selection between the different modes for generating a forward link signal or reverse link signals. The REV_LINK modes will be described in the following sections.
FWD_LINK_18	<p>Activates the generation of a forward link signal with up to 18 code channels (channel No. 0 to 17). The Walsh code (WALSH CODE) and the source for modulation data (DATA) can be determined individually for each channel. Each channel can be switched on/off (STATE). The relative power (POWER) of channels 0 (pilot), 1 and 2 can be freely determined in range -30 dB to 0 dB.</p> <p>The power setting of channel 3 also determines the power setting of channels 4 to 17. This means that channels 3 to 17 all have the same power provided that the channels are switched on.</p> <p>IEC/IEEE-bus SOUR:IS95:MODE FLIN18</p>
FWD_LINK_64	<p>Activates the generation of a forward link signal with up to 64 code channels. Walsh codes 0 to 63 (WALSH CODE) are assigned to the channels.</p> <p>The source for modulation data (DATA) can be determined individually for each channel. Each channel can be switched on/off (STATE). The relative power (POWER) of the pilot channel (Walsh 0) can be freely determined in range -30 dB to 0 dB.</p> <p>The power setting of channel 1 also determines the power setting of channels 2 to 63. This means that channels 1 to 63 all have the same power provided that the channels are is switched on.</p> <p>IEC/IEEE-bus SOUR:IS95:MODE FLIN64</p>
REV_LINK	<p>Activates the generation of a reverse link signal without channel coding. A selection between the full-rate and half-rate mode (RATE) is possible.</p> <p>IEC/IEEE-bus SOUR:IS95:MODE RLIN</p>
REV_LINK_CODED	<p>Activates the generation of a reverse link signal with channel coding. A selection between the access channel and traffic channel with different rates is possible.</p> <p>IEC/IEEE-bus SOUR:IS95:MODE RLCO</p>

SET DEFAULT ►

Provides the default setting for the channel configuration of the forward link modes.

For FWD_LINK_18:

- channels 0 to 8 are switched on
- the power of the pilot channel (channel 0) makes out 20% of the total power (-7 dB).
- channel 1 is set as sync channel by WALSH CODE 32
- channel 2 is set as paging channel
- the remaining 7 channels are configured as traffic channels

The power setting was selected according to the "Base Station Test Model" of TIA standard IS-97.

For FWD_LINK_64:

- all 64 channels are switched on
- the power of the pilot channel makes out 20% of the total power (-7 dB).
- the remaining 80% of the transmit power is distributed equally on the remaining 63 channels.

IEC/IEEE-bus command SOUR:IS95:PRES

MODULATION...

Opens a window for setting the modulation parameters.

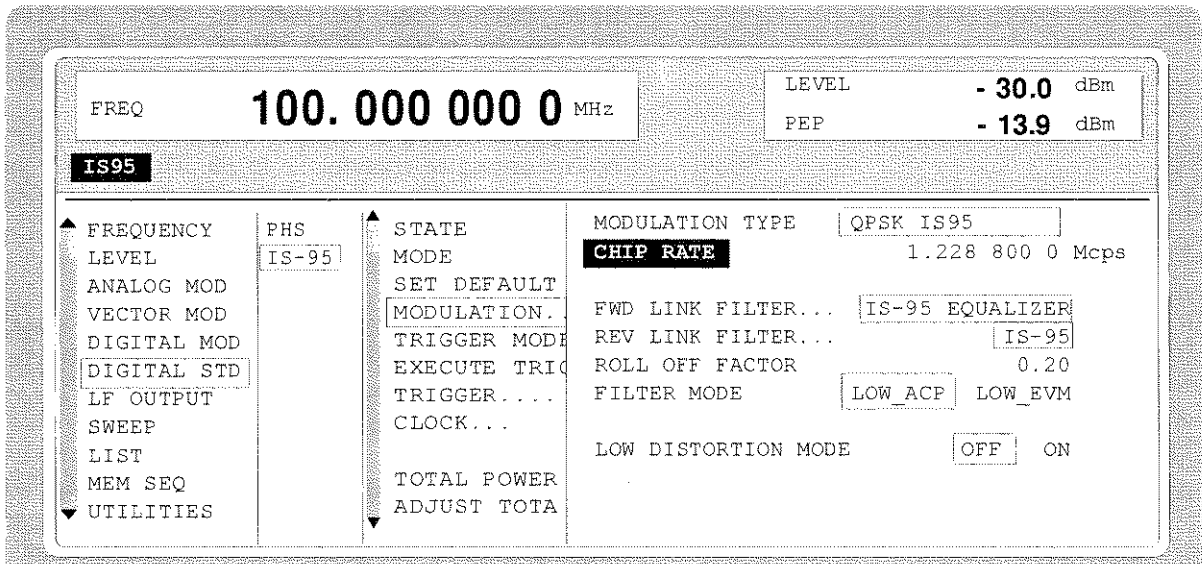

Fig. 2-75 Menu DIGITAL STD - IS-95 - MODULATION...

(MODULATION...)

MODULATION TYPE Indicates the modulation type.

CHIP RATE Setting value of chip clock frequency. Preset to 1.2288 Mcps.

IEEE-bus command SOUR:IS95:CRAT 1.2 MHZ

(MODULATION...)	FWD LINK FILTER...	<p>Opens a window for selecting the baseband filters for the forward link.</p> <p>A selection between the FIR filters defined in IS-95 or the Nyquist filters COS and SQRCOS is possible. A FIR filter is preset with equalizer according to IS-95.</p> <p>IEEE command SOUR:IS95:FILT:FTYP EIS95</p>
	REV LINK FILTER...	<p>Opens a window for selecting the baseband filter for the reverse link.</p> <p>A selection between the FIR filters defined in IS-95 or the Nyquist filters COS and SQRCOS is possible. A FIR filter is preset according to IS-95.</p> <p>IEEE command SOUR:IS95:FILT:RTYP IS95</p>
	ROLL OFF FACTOR	<p>Setting value of roll-off factor.</p> <p>The setting is only possible provided that a COS or SQRCOS filter is selected under FILTER.</p> <p>IEEE-bus command SOUR:IS95:FILT:PAR 0.22</p>
	FILTER MODE	<p>Selection of filter mode.</p> <p>LOW_ACP Filter for minimum <u>A</u>djacent <u>C</u>hannel <u>P</u>ower. IEEE SOUR:IS95:FILT:MODE LACP</p> <p>LOW_EVM Filter for minimum vector error. IEEE SOUR:IS95:FILT:MODE LEVM</p>
	LOW DISTORTION MODE	<p>Switch on/off of low-distortion mode.</p> <p>After switch-on, the level of the IQ baseband signals is reduced by 3 dB. In some cases, this might reduce undesired intermodulation products. OFF is normally the more favourable setting.</p> <p>IEC/IEEE-bus command SOUR:IS95:LDIS OFF</p>
TRIGGER MODE...		<p>Opens a window for selecting the CDMA sequence.</p>
	AUTO	<p>The calculated CDMA chip sequence is cyclically repeated.</p> <p>IEC/IEEE-bus command SOUR:IS95:SEQ AUTO</p>
	RETRIG	<p>The CDMA chip sequence is continuously repeated. A trigger event causes a restart from frame 1.</p> <p>IEC/IEEE-bus command SOUR:IS95:SEQ RETR</p>
	ARMED_AUTO	<p>The CDMA chip sequence cannot be started from frame 1 until a trigger event has occurred. The unit then automatically switches over to the AUTO mode and can no longer be triggered.</p> <p>IEC/IEEE-bus command SOUR:IS95:SEQ AAUT</p>
	ARMED_RETRIG	<p>The CDMA chip sequence cannot be started from frame 1 until a trigger event has occurred. each new trigger event causes a restart.</p> <p>IEC/IEEE-bus command SOUR:IS95:SEQ ARET</p>

EXECUTE TRIGGER ▶ Executes a trigger event to start the CDMA chip sequence.
IEC/IEEE-bus command : TRIG:DM IMM

TRIGGER... Opens a window for selecting the trigger source, for configuring the trigger output signals and for setting the time delay of an external trigger signal.

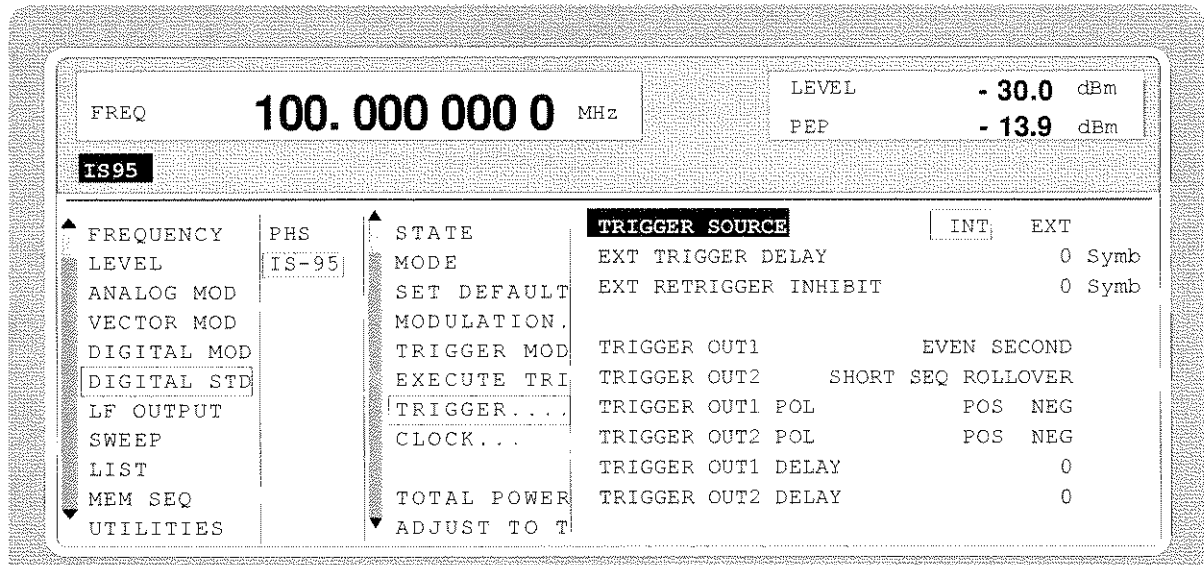

Fig. 2-76 Menu DIGITAL STD - IS-95 - TRIGGER...

(TRIGGER...)	TRIGGER SOURCE	Selection of trigger source.
	EXT	The CDMA chip sequence is started from frame 1 by means of the active slope of an external trigger signal. The polarity, the trigger threshold and the input resistance of the TRIGIN input can be modified in menu DIGITAL MOD - EXT INPUTS.
	INT	A trigger event is manually executed by EXECUTE TRIGGER.
		IEC/IEEE-bus SOUR: IS95:TRIG:SOUR EXT
	EXT TRIGGER DELAY	Setting the number of chips (symbols) by which an external trigger signal is delayed before it starts the CDMA chip sequence.
		This is used for setting the time synchronicity between the DUT and other units.
		IEC/IEEE-bus SOUR: IS95:TRIG:DEL 3

(TRIGGER...)	EXT RETRIGGER INHIBIT	<p>Setting the number of chips for which a restart is inhibited after a trigger event. With TRIGGER MODE RETRIG selected, each new trigger signal restarts the CDMA chip sequence. This restart can be inhibited for the entered number of chips (symbols). Example: The entry of 98000 symbols, for example, causes new trigger signals to be ignored for the duration of 98000 chips after a trigger event. IEC/IEEE-bus SOUR:IS95:TRIG:INH 16000</p>																				
	TRIGGER OUT 1/2	<p>Selection of signals for outputs TRIGOUT 1 and TRIGOUT 2 of connector PARADATA. All the times indicated are valid for a chip rate of 1.2288 Mcps.</p> <table border="0"> <tr> <td data-bbox="841 737 1057 770">TRAFFIC FRAME</td> <td data-bbox="1175 737 1398 770">20-ms frame clock</td> </tr> <tr> <td data-bbox="971 774 1138 808">IEC/IEEE-bus</td> <td data-bbox="1166 774 1471 808">SOUR:IS95:OUTP1 TFR</td> </tr> <tr> <td data-bbox="841 812 1149 846">SHORT SEQ ROLLOVER</td> <td data-bbox="1175 812 1344 846">80/3-ms clock</td> </tr> <tr> <td data-bbox="971 850 1138 884">IEC/IEEE-bus</td> <td data-bbox="1166 850 1471 884">SOUR:IS95:OUTP1 SSR</td> </tr> <tr> <td data-bbox="841 888 1036 921">SUPER FRAME</td> <td data-bbox="1175 888 1321 921">80-ms clock</td> </tr> <tr> <td data-bbox="971 926 1138 959">IEC/IEEE-bus</td> <td data-bbox="1166 926 1471 959">SOUR:IS95:OUTP1 SFR</td> </tr> <tr> <td data-bbox="841 963 1036 997">EVEN SECOND</td> <td data-bbox="1175 963 1284 997">2-s clock</td> </tr> <tr> <td data-bbox="971 1001 1122 1035">IEC/IEEE-bus</td> <td data-bbox="1166 1001 1471 1035">SOUR:IS95:OUTP1 ESEC</td> </tr> <tr> <td data-bbox="841 1039 906 1073">PCG</td> <td data-bbox="1175 1039 1471 1073">power control group rate</td> </tr> <tr> <td data-bbox="971 1077 1122 1110">IEC/IEEE-bus</td> <td data-bbox="1166 1077 1471 1110">SOUR:IS95:OUTP1 GATE</td> </tr> </table>	TRAFFIC FRAME	20-ms frame clock	IEC/IEEE-bus	SOUR:IS95:OUTP1 TFR	SHORT SEQ ROLLOVER	80/3-ms clock	IEC/IEEE-bus	SOUR:IS95:OUTP1 SSR	SUPER FRAME	80-ms clock	IEC/IEEE-bus	SOUR:IS95:OUTP1 SFR	EVEN SECOND	2-s clock	IEC/IEEE-bus	SOUR:IS95:OUTP1 ESEC	PCG	power control group rate	IEC/IEEE-bus	SOUR:IS95:OUTP1 GATE
TRAFFIC FRAME	20-ms frame clock																					
IEC/IEEE-bus	SOUR:IS95:OUTP1 TFR																					
SHORT SEQ ROLLOVER	80/3-ms clock																					
IEC/IEEE-bus	SOUR:IS95:OUTP1 SSR																					
SUPER FRAME	80-ms clock																					
IEC/IEEE-bus	SOUR:IS95:OUTP1 SFR																					
EVEN SECOND	2-s clock																					
IEC/IEEE-bus	SOUR:IS95:OUTP1 ESEC																					
PCG	power control group rate																					
IEC/IEEE-bus	SOUR:IS95:OUTP1 GATE																					
	TRIGGER OUT 1/2 POL	<p>Selection of signal polarity at outputs TRIGOUT 1 and TRIGOUT 2 of the PARADATA connector. IEC/IEEE-bus :SOUR:IS95:OUTP1:POL NORM</p>																				
	TRIGGER OUT 1/2 DELAY	<p>Setting the number of chips by which the selected trigger signal is delayed. IEC/IEEE-bus :SOUR:IS95:OUTP1:DEL -50</p>																				

CLOCK...

Opens a window for selecting the clock source.

The CDMA chip clock in SMIQ corresponds to the symbol clock of the modulation. Therefore, the terms symbol clock and chip clock are synonymous.

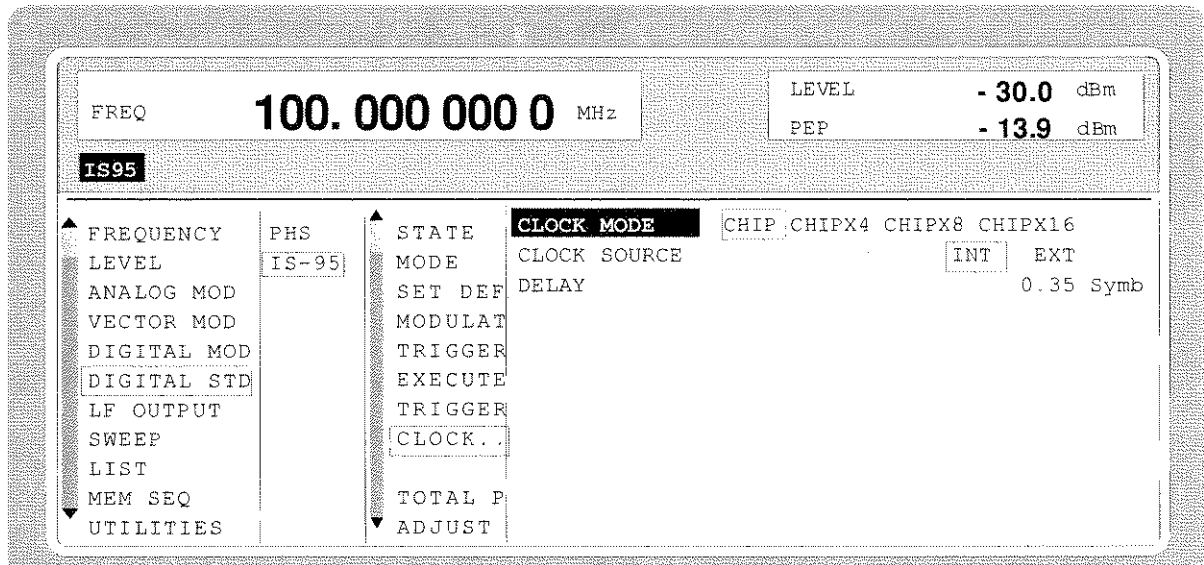

Fig. 2-77 Menu DIGITAL STD - IS-95 - CLOCK...

(CLOCK...)

MODE

Selection of the type of external clock signal.

CHIP Chip clock

CHIPXn Four-, eight- or sixteen-fold chip clock (n=4, 8 or 16).

IEC/IEEE-bus : SOUR: IS95: CLOC: MODE CHIP

CLOCK SOURCE

Selection of clock source.

INT SMIQ uses internally generated clock signals.

EXT An external chip clock is fed in at connector SYMBOL CLOCK. Multifolds of the chip clock are fed in at connector BIT CLOCK

The clock synthesizer on the modulation coder is synchronized to this clock. Parameter CHIP RATE has to be set with an accuracy of ± 1 %.

The polarity, the trigger threshold and the input resistance of the SYMBOL CLOCK input can be modified in menu DIGITAL MOD - EXT INPUTS.

IEC/IEEE-bus SOUR: IS95: CLOC: SOUR INT

(CLOCK...)	DELAY	<p>Setting the delay of generated modulation signal to an external clock.</p> <p>This can be used, for example, for synchronization with a second unit to achieve time synchronicity between the modulation signals of the two units.</p> <p>The displayed setting resolution of 1/100 symbol is only attained for symbol-clock frequencies below 100 kHz.</p> <p>The resolution is reduced with increasing frequency. At a chip rate of 1.2288 Mcps, the resolution equals the chip duration $\times 0.1$.</p> <p>IEC/IEEE-bus SOUR: IS95:CLOC:DEL 0.5</p>
TOTAL POWER		<p>Display of total average power at RF output. The display is only valid, if TOTAL POWER does not exceed the displayed LEVEL. The I/Q modulator can thus be protected from being overloaded. In addition to average power (LEVEL) the peak envelope power (PEP) is also indicated in the header of the display. The value for PEP is calculated based on a worst case. The actual peak powers are mostly smaller.</p> <p>IEC/IEEE-bus command : SOUR: IS95:POW?</p>
ADJUST TOTAL POWER ►		<p>Changes the value of power of the activated code channel. After the setting the TOTAL POWER is equal to the power indicated in the LEVEL display.</p> <p>The power ratios of different code channels are retained.</p> <p>IEC/IEEE-bus command : SOUR: IS95:POW:ADJ</p>
SAVE/RCL MAPPING...		<p>Saves/calls up the set channel configuration. This setting is only possible in the forward link mode.</p> <p>For FWD_LINK_18, the following is saved for each channel number:</p> <ul style="list-style-type: none"> - selected WALSH CODE - set POWER - type of modulation data (DATA) and - switch-on state. <p>For FWD_LINK_64, the following is saved for each channel number:</p> <ul style="list-style-type: none"> - set POWER - modulation data (DATA) and - switch-on state. <p>The channel configuration of the two forward-link modes is stored and loaded at the same time.</p>

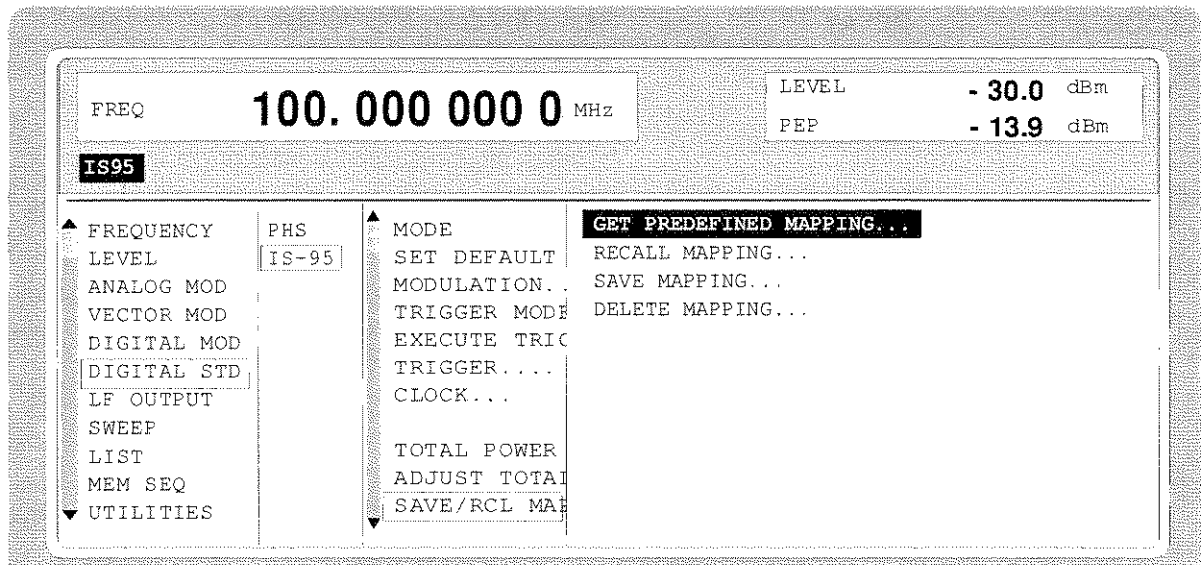

Fig. 2-78 Menu DIGITAL STD - IS-95 - SAVE/RCL MAPPING...

(SAVE/RCL MAPPING...)	GET PREDEFINED MAP	<p>Loads a factory-set channel configuration.</p> <p>PILOT A pilot signal is generated only.</p> <p>09CHAN A signal with 9-code channels is generated according to the Base Station Test Model (IS95).</p> <p>18CHAN A signal with 18-code channels is generated.</p> <p>IEEE :SOUR:IS95:MAPP:SEL:PREDEF "pilot"</p>
	RECALL MAPPING...	<p>Loads a stored channel configuration.</p> <p>IEEE-bus SOUR:IS95:MAPP:LOAD "name"</p>
	SAVE MAPPING...	<p>Stores the channel configuration. For remote control, a name with 7 characters at max. can be used.</p> <p>IEEE-bus :SOUR:IS95:MAPP:STOR "name"</p>
	DELETE MAPPING...	<p>Deletes a stored channel configuration.</p> <p>IEEE bus SOUR:IS95:MAPP:DEL "name"</p>

CHANNEL NO Display of channel number.
This menu column is only displayed in the forward link mode.

WALSH CODE Setting the Walsh code.
This menu column is only displayed in the forward link mode.

For FWD_LINK_18

- the Walsh code can be set individually for each channel.

IEC/IEEE-bus command SOUR:IS95:CHAN1:WALS 32

For FWD_LINK_64

- the Walsh code cannot be set. In this mode, the Walsh code corresponds to the channel number. All the 64 code channels are displayed.

POWER

Setting the power of channel.

This menu column is only displayed in the forward link mode.

POWER indicates the average power of the code channel relative to the power indicated in LEVEL display (code domain power).

For FWD_LINK_18

- the power of channels 0, 1, 2 is set individually.
- the other channels have the same power. The power for all the channels is set in channel 3.

For FWD_LINK_64

- the power of the pilot channel is set individually.
- the other channels have the same power. The power for all the channels is set in channel 1.

IEC/IEEE-bus command SOUR:IS95:CHAN1:POW -10 DB

DATA

Setting the modulation data for the selected code channel.

This menu column is only displayed in the forward link mode.

The data rate for all forward link channels corresponds to the chip rate/64, ie 19200 bps at a chip rate of 1.2288 Mcps

0000 Continuous sequence of zeros

IEC/IEEE-bus command SOUR:IS95:CHAN1:DATA ZERO

1111 Continuous sequence of ones

IEC/IEEE-bus command SOUR:IS95:CHAN1:DATA ONE

1010 Alternating sequence of zeros and ones

IEC/IEEE-bus command SOUR:IS95:CHAN1:DATA ALT

PRBS Pseudo random data, different in every code channel

IEC/IEEE-bus command SOUR:IS95:CHAN1:DATA PRBS

STATE

Switch on/off of assigned code channel.

This menu column is only displayed in the forward link mode.

IEC/IEEE-bus command SOUR:IS95:CHAN1:STAT ON

2.12.5 Menu CDMA Standard - Reverse Link Signal without Channel Coding

Menu DIGITAL STD - IS-95 provides access to settings for IS-95 CDMA signal generation. The following figure shows the menu for generating the reverse link signal (transmit signal of mobile station) without signal coding. The previous section showed the menu for generating the forward link signals as well as the parameters that are identical for both modes.

Menu selection: DIGITAL STD - IS-95- MODE - REV_LINK

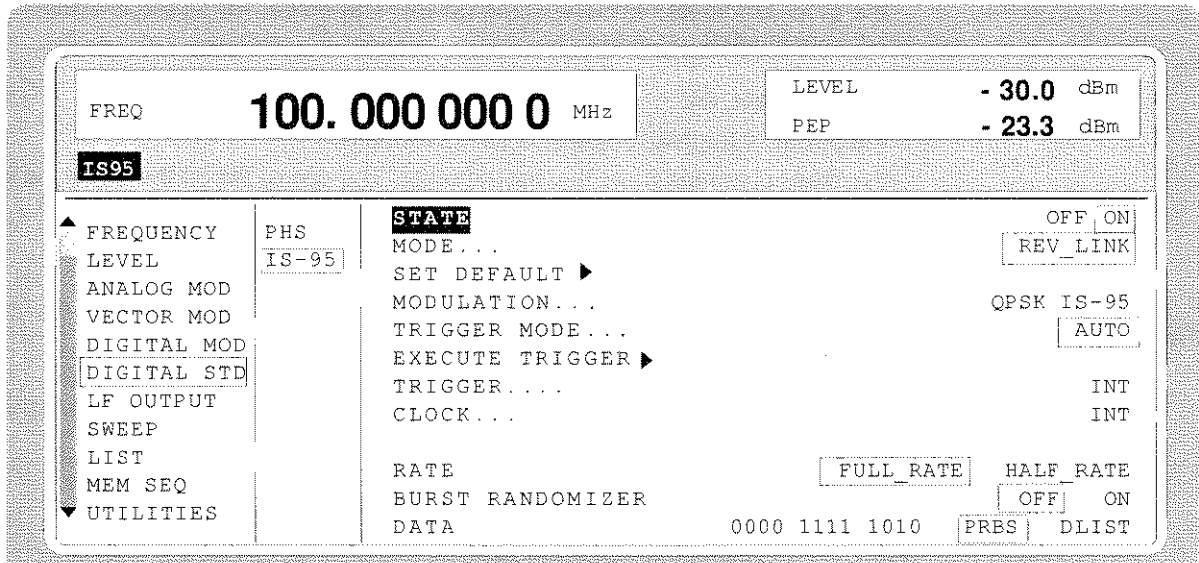

Fig. 2-79 Menu DIGITAL STD - IS-95 - MODE - REV_LINK

STATE to CLOCK see section "Menu CDMA-Standard- Forward Link Signal"

RATE Selection of full-rate or half-rate transmission of modulation data. This selection is only possible in the reverse link mode. In the half-rate mode, only 8 of 16 power control groups of a frame are transmitted ("power gating").

IEC/IEEE-bus command SOUR: IS95:RATE HALF

BURST RANDOMIZER Switch on/off of burst randomizer. This selection is only possible during half-rate transmission in the reverse link mode.

OFF Every second power control group is transmitted.

ON A random algorithm determines which eight of the 16 power control groups of a frame will be transmitted.

IEC/IEEE-bus command SOUR: IS95:RAND ON

DATA Selection of modulation data for the reverse link signal. The data rate corresponds to the chip rate x3/128, ie 28800 bps at 1.2288 Mcps.

0000 Continuous sequence of zeros
IEC/IEEE-bus SOUR: IS95:DATA ZERO

1111 Continuous sequence of ones
IEC/IEEE-bus SOUR: IS95:DATA ONE

1010 Alternating zeros and ones
IEC/IEEE-bus SOUR: IS95:DATA ALT

PRBS PRBS data.
IEC/IEEE-bus SOUR: IS95:DATA PRBS

DLIST Data from a programmable data list.
IEC/IEEE-bus :SOUR: IS95:DATA DLIS

2.12.6 Menu CDMA Standard - Reverse Link Signal with Channel Coding

Menu DIGITAL STD - IS-95 provides access to settings for generating IS-95 CDMA signals. The following figure shows the menu for generating a reverse link signals with channel coding. The section on the menu for forward link signal generation shows the parameters that are identical for both modes.

Menu selection: DIGITAL STD - IS-95- MODE - REV_LINK_CODED

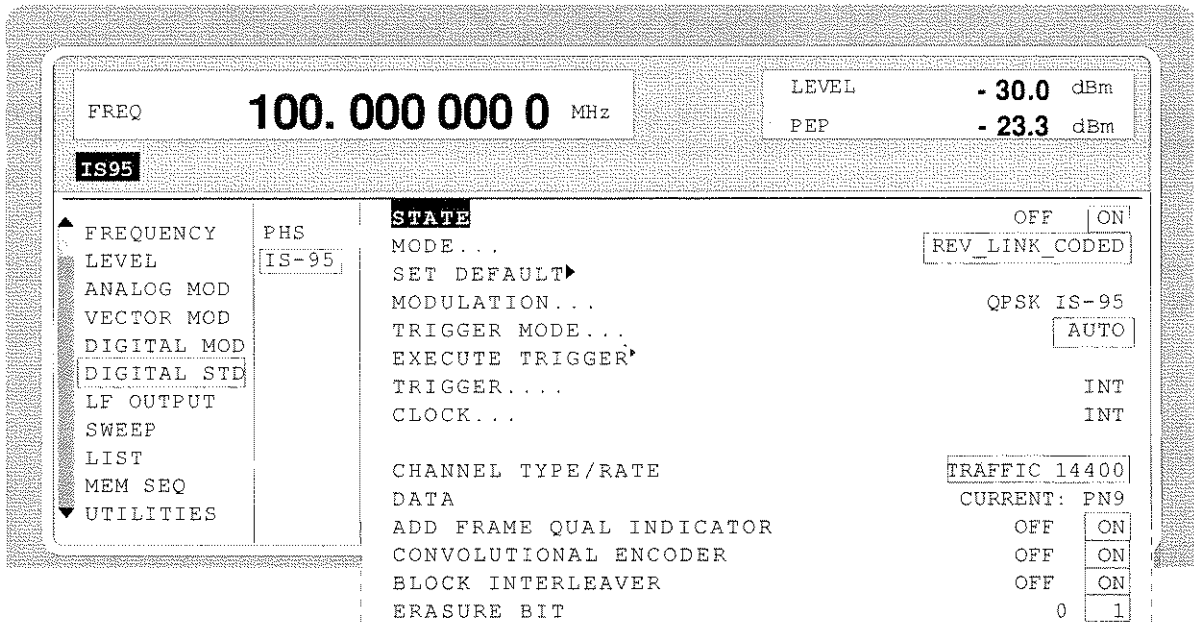

Fig. 2-80 Menu DIGITAL STD - IS-95 - MODE - REV_LINK_CODED

Parameter **STATE** to **CLOCK...** see section "Menu CDMA Standard - Forward Link Signal"

CHANNEL TYPE/RATE

Selects the type of channel and the associated data rate. This selection is only possible in the reverse link mode. The selection also determines the structure of the channel coding and the number of data bits to be inserted into each frame.

- TRAFFIC 14400 Traffic channel with 14400 bps. 267 bits are inserted into each frame
- TRAFFIC 7200 Traffic channel with 7200 bps. 125 bits are inserted into each frame
- TRAFFIC 3600 Traffic channel with 3600 bps. 55 bits are inserted into each frame
- TRAFFIC 1800 Traffic channel with 1800 bps. 21 bits are inserted into each frame
- ACCESS 4800 Access channel with 4800 bps. 88 bits are inserted into each frame
- TRAFFIC 9600 Traffic channel with 9600 bps. 172 bits are inserted into each frame
- TRAFFIC 4800 Traffic channel with 4800 bps. 80 bits are inserted into each frame
- TRAFFIC 2400 Traffic channel with 2400 bps. 40 bits are inserted into each frame
- TRAFFIC 1200 Traffic channel with 1200 bps. 16 bits are inserted into each frame

```

IEC/IEEE-bus : SOUR: IS95:RLC:CTYP TRAF7200
              : SOUR: IS95:RLC:CTYP ACC4800
    
```

DATA SOURCE	Selects the modulation data for the reverse link signal with channel coding. The data are continuously inserted into the data field of the corresponding frame. PN.. PRBS data to CCITT with period length between 2^9-1 and $2^{23}-1$. IEC/IEEE-bus command : SOUR:IS95:RLC:DATA PN1 DLIST Data from a previously programmed and stored data list. IEC/IEEE-bus command : SOUR:IS95:RLC:DATA DLIST
ADD FRAME QUAL INDICATOR	Switches the frame quality indicator (CRC calculation) on or off. With OFF selected, only zeros are sent instead of CRC bits. IEC/IEEE-bus command : SOUR:IS95:RLC:FQIN ON
CONVOLUTIONAL ENCODER	Switches the convolutional encoder on or off. With OFF selected, the data rate is attained by repeating the symbol. IEC/IEEE-bus command : SOUR:IS95:RLC:CENC ON
BLOCK INTERLEAVER	Switches the interleaver function on or off. IEC/IEEE-bus command : SOUR:IS95:RLC:BINT ON
ERASURE BIT	Selects 1 or 0 for the erasure bit. IEC/IEEE-bus command : SOUR:IS95:RLC:EBIT 0

2.13 Digital Standard NADC

With the options Modulation Coder (SMIQB10) and Data Generator (SMIQB11) provided, modulation signals according to the American NADC standard (IS-54¹ or IS-136) can be generated. NADC is a TDMA standard for cellular mobile radio networks.

SMIQ can generate both the transmit signal of a base station (BS) and the transmit signal of a mobile station (MS). Transmission from BS to MS is called "downlink", "uplink" being used for transmission in the opposite direction.

Each TDMA frame consists of 6 slots. The 6 slots can be configured for both full rate and half rate mode. For half rate, the data content for each of the 6 slots can be defined separately by means of a slot editor whereas in the full rate mode 2 slots for example slot 1 and 4 are combined in a frame. The settings for the first slot are then automatically used for the assigned second slot. Each slot can be switched on or off. Moreover, a defined intermediate level can be set for uplink slots.

A burst type has to be defined to configure a slot. The following burst types can be selected:

- TCH a traffic channel burst with a different structure for uplink and downlink,
- SHORT the so-called "shortened burst" only available during uplink and,
- ALL_DATA burst type for test purposes with freely programmable data contents in the selected slot.

The following internal modulation sources are available:

- different PRBS generators with a sequence length between 2^9-1 and $2^{23}-1$ and
- data lists, ie freely programmable data sequences from the data generator memory.

For generating the NADC signals, SMIQ inserts the modulation data continuously (in real time) into the selected slots. Using a digital signal processor the data generator generates a data sequence with modulation data and control signals for envelope control.

The data generator in SMIQ generates a data stream which is converted into IQ signals in the modulation coder. According to the NADC standard, the modulation type is $\pi/4$ DQPSK at a symbol rate of 24.3 ksymbol/s and $\sqrt{\text{COS}}$ filtering. Symbol rate and filtering can be changed in SMIQ.

¹ Personal Handy Phone System ARIB Standard (RCR STD-28)

2.13.1 Sync and Trigger Signals

The data generator generates a data sequence with modulation data, control signals for envelope control, and synchronization signals.

When TRIGGER MODE AUTO is selected, the NADC signal generation is started automatically.

This start can also be activated by an external trigger signal (TRIGGER MODE ARMED_AUTO) which allows a synchronous sequence for BER measurements to be carried out on receivers.

A trigger signal can be fed via the TRIGIN input at connector PAR DATA. The active slope of a trigger signal applied there executes a trigger event.

NADC signal generation at a frame limit is started after a trigger event. Data from data lists are inserted into the selected slots starting from the first bit. PRBS generators start with the set initialization status.

Signal generation either starts immediately after the active slope of the trigger signal or after a settable number of symbols (EXT TRIGGER DELAY). Retriggerring (RETRIG) can be inhibited for a settable number of symbols (EXT RETRIGGER INHIBIT).

A trigger event can be executed manually or via the IEC/IEEE bus using EXECUTE TRIGGER.

When a trigger event is executed, a trigger signal is output at the TRIGOUT 3 output of SMIQ.

SMIQ also generates the following sync signals:

- a frame clock at TRIGOUT 1 output,
- a frame or multiframe clock at TRIGOUT 2 output with settable position in the frame,
- the symbol clock and the bit clock.

A clock synthesizer on the modulation coder generates the symbol clock and the bit clock in SMIQ. All the clock signals are synchronized to the 10-MHz reference of SMIQ. The symbol clock is available at connector SYMBOL CLOCK and the bit clock at connector BIT CLOCK. If required, the clock synthesizer in SMIQ can be synchronized to an external symbol or bit clock.

The clock signal is selected in the menu via CLOCK-CLOCK SOURCE EXT.

To allow for a trouble-free synchronization of the clock synthesizer first apply the external clock and set the correct symbol rate at SMIQ. Then switch CLOCK SOURCE from INT to EXT.

Note: *The set symbol rate should not differ by more than 1% from the symbol rate of the external signal.*

2.13.2 PN Generators as Internal Data Source

Independent PN generators (Pseudo Noise) can be selected for each slot as data source for data fields DATA and SACCH. These PN generators provide pseudo-random bit sequences of different length or period. That is why they are also called PRBS generators (Pseudo Random Binary Sequence). Data sequences are sequences of maximum length which are generated by means of feedback shift registers.

The following figure gives an example of a 9 bit generator with feedbacks after register 4 and 0 (output).

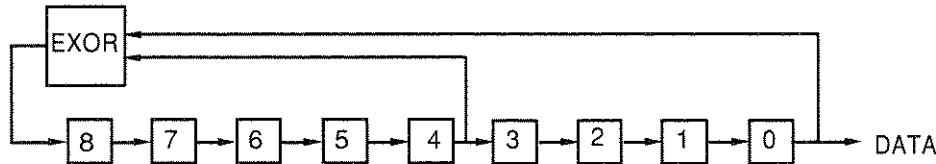

The pseudo-random sequence of a PRBS generator is clearly defined by the number of registers and the feedback. The following table describes all PRBS generators available:

Table 2-17 PRBS generators for NADC

PRBS generator	Length in bits	Feedback after
9 bit	$2^9 - 1 = 511$	Register 4, 0
11 bit	$2^{11} - 1 = 2047$	Register 2, 0
15 bit	$2^{15} - 1 = 32767$	Register 1, 0
16 bit	$2^{16} - 1 = 65535$	Register 5, 3, 2, 0
20 bit	$2^{20} - 1 = 1048575$	Register 3, 0
21 bit	$2^{21} - 1 = 2097151$	Register 2, 0
23 bit	$2^{23} - 1 = 8388607$	Register 5, 0

PN generators PN9,11,15,20 and PN23 are configured according to CCITT Rec. 0.151/152/153. The output sequence is inverted for generators PN15 and PN23.

The start value of the PN generators is different in the slots and equals

$$\text{start value} = 1 + 14 \text{ hex} \times \text{slot number}$$

Example: PN9 generator in slot 1 with start value 15hex = 10101 binary.

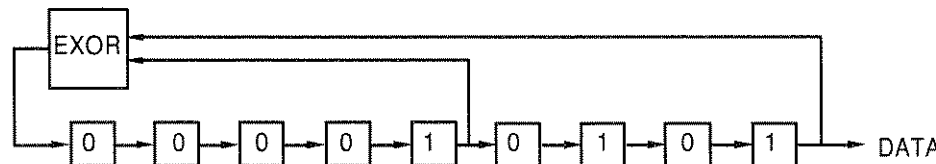

The resulting output sequence is 1010100000010100101011110010 etc.

2.13.3 Lists as Internal Data Source

A freely programmable memory on the data generator serves as internal data source for the data fields of the slots. The data are managed in so-called lists. A list editor allows to select, copy, modify and delete data lists (DATA LIST).

The list editor is available via menu DIGITAL-MOD - SOURCE....

2.13.4 External Modulation Data

External data can (only) be applied via the SERDATA interface. A selection of SERDATA as data source is only possible for a single data field of a slot. For further information on the characteristics of the SERDATA interface see Annex A.

To ensure that the external data bits are assigned to specific positions in the data field of the selected slot and that they are reproducible, the buffer of the RS-232 transmitter and receiver has to be deleted. A triggered start has to follow.

The following setting sequence is required in the DIGITAL STD - NADC menu:

1. Carry out desired settings in menu.
2. Select data source SERDATA for the data field of the slot using SELECT SLOT -
3. Make connection to external data source, but do not yet start external data source.
4. Switch off digital standard using STATE - OFF.
5. Set TRIGGER MODE ARMED_AUTO.
In this state, SMIQ is ready for reception, but discards data that are read in via SERDATA.
6. Switch on digital standard with STATE ON.
7. Start external data source.
The read-in data are written into the receiving buffer. Only if this buffer is filled can SMIQ react to a trigger event.
8. Activate trigger event. Signal generation is thus started at a frame limit. The first bit received via SERDATA is put to the first bit position in the selected data field.

2.13.5 Menu DIGITAL STANDARD - NADC

Menu DIGITAL STD - NADC provides access to settings for generating NADC signals.

Menu selection: DIGITAL STD - NADC

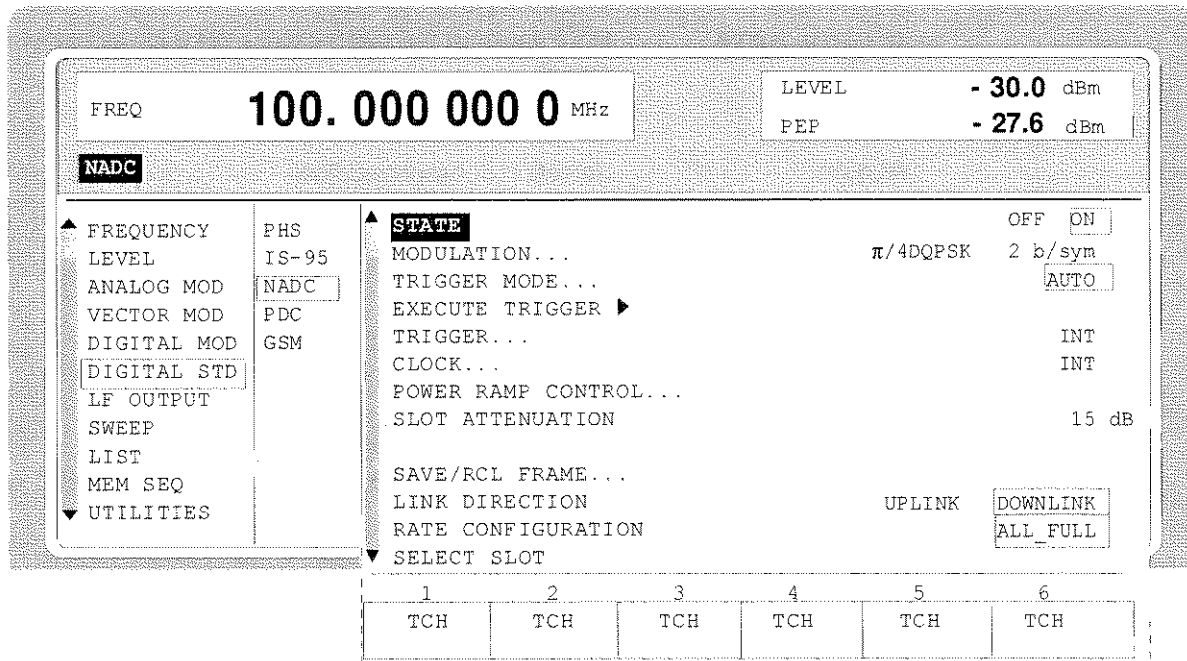

Fig. 2-81 Menu DIGITAL STD - NADC, SMIQ equipped with Modulation Coder SMIQB10 and Data Generator SMIQB11

STATE Switch on/off of Digital Standard NADC modulation. Vector Modulation or Digital Modulation will be switched off automatically.
IEC/IEEE-bus command : SOUR:NADC:STAT ON

MODULATION... Opens a window for setting the modulation parameters.

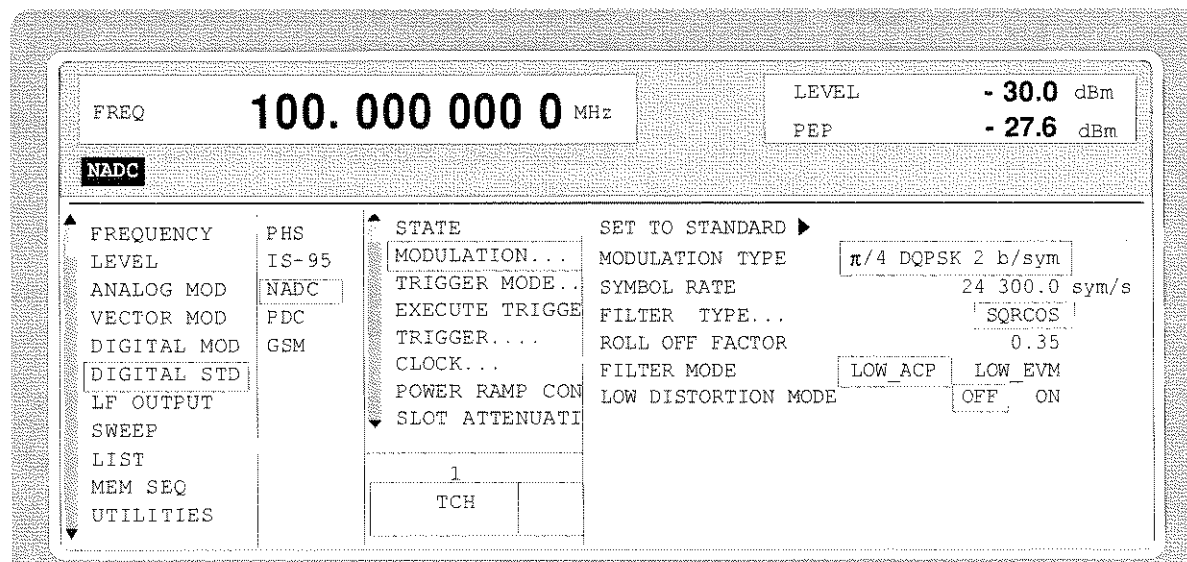

Fig. 2-82 Menu DIGITAL STD - NADC - MODULATION..., SMIQ equipped with Modulation Coder SMIQB10 and Data Generator SMIQB11

(MODULATION...)	SET TO STANDARD ►	Sets the subsequent modulation parameters to the values predefined by the standard.
	MODULATION TYPE	Displays the modulation type.
	SYMBOL RATE	Input value for the symbol clock. 24.3 ksymbol/s are preset. IEC/IEEE-bus : SOUR:NADC:SRAT 24.31KHZ
	FILTER	Selection of baseband filter. A selection between Nyquist filters COS and SQR COS is possible. IEC/IEEE-bus : SOUR:NADC:FILT:TYPE COS
	ROLL OFF FACTOR	Input value for the roll-off factor. IEC/IEEE-bus : SOUR:NADC:FILT:PAR 0.35
	FILTER MODE	Selection of filter mode. LOW_ACP Filter for minimum <u>A</u> djacent <u>C</u> hannel <u>P</u> ower. IEEE : SOUR:NADC:FILT:MODE LACP LOW_EVM Filter for minimum vector error. IEEE : SOUR:NADC:FILT:MODE LEVM
	LOW DISTORTION	Switch on/off of low-distortion mode.. After switch-on, the level of the IQ baseband signals is reduced by 3 dB. In some cases, this might reduce undesired intermodulation products. OFF is normally the more favourable setting. IEC/IEEE-bus command : SOUR:NADC:LDIS OFF
TRIGGER MODE...		Opens a window for selecting the trigger mode.
	AUTO	The NADC signals are continuously transmitted in the activated slots. IEC/IEEE-bus : SOUR:NADC:SEQ AUTO
	RETRIG	The NADC signals are continuously transmitted in the activated slots. A trigger event causes a restart. IEC/IEEE-bus : SOUR:NADC:SEQ RETR
	ARMED_AUTO	The NADC signal generation does not start until a trigger event has occurred. The unit then automatically switches over to the AUTO mode and can no longer be triggered. IEC/IEEE-bus : SOUR:NADC:SEQ AAUT
	ARMED_RETRIG	The NADC signal generation does not start until a trigger event has occurred. The unit then automatically switches over to the RETRIG mode. Each new trigger event causes a restart. IEC/IEEE-bus : SOUR:NADC:SEQ ARET

EXECUTE TRIGGER ▶ Executes a trigger even to start the NADC signal generation.
IEC/IEEE-bus command :TRIG:DM IMM

TRIGGER... Opens a window for selecting the trigger source, for configuring the trigger output signals and for setting the time delay of an external trigger signal.

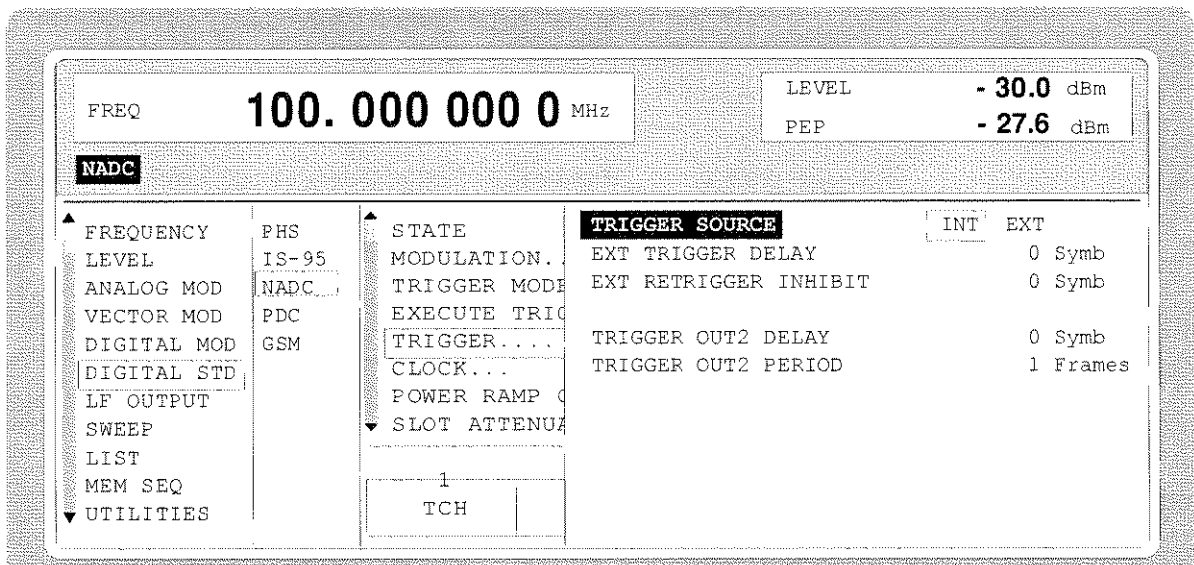

Fig. 2-83 Menu DIGITAL STD - NADC_TRIGGER..., SMIQ equipped with Modulation Coder SMIQB10 and Data Generator SMIQB11

(TRIGGER...)	TRIGGER SOURCE	<p>Selection of trigger source.</p> <p>EXT The NADC signal generation is started by the active slope of an external trigger signal. The polarity, the trigger threshold and the input resistance of the TRIGIN input can be modified in menu DIGITAL MOD - EXT INPUTS.</p> <p>INT A trigger event can be executed by EXECUTE TRIGGER ▶.</p> <p>IEC/IEEE-bus : SOUR:NADC:TRIG:SOUR EXT</p>
	EXT TRIGGER DELAY	<p>Setting the number of symbols by which an external trigger signal is delayed before it starts the NADC signal generation. This is used for setting the time synchronization between the the SMIQ and the DUT.</p> <p>IEC/IEEE-bus : SOUR:NADC:TRIG:DEL 3</p>

- (TRIGGER...) **EXT RETRIGGER INHIBIT** Setting the number of symbols for which a restart is inhibited after a trigger event. With TRIGGER MODE RETRIG selected, each new trigger signal restarts the NADC signal generation. This restart can be inhibited for the entered number of symbols.
 Example:
 The entry of 1000 symbols causes new trigger signals to be ignored for the duration of 1000 symbols after a trigger event
 IEC/IEEE-bus : SOUR:NADC:TRIG:INH 1000
- TRIGGER OUT 2 DELAY** Input value of delay of trigger signal at TRIGOUT 2 output compared with beginning of frame.
 IEC/IEEE-bus : SOUR:NADC:TRIG:OUTP:DEL 2
- TRIGGER OUT2 PERIOD** Input value of output signal period at TRIGOUT 2 output given in frames.
 IEC/IEEE-bus : SOUR:NADC:TRIG:OUTP:PER 1

CLOCK... Opens a window for selecting the clock source and for setting a delay.

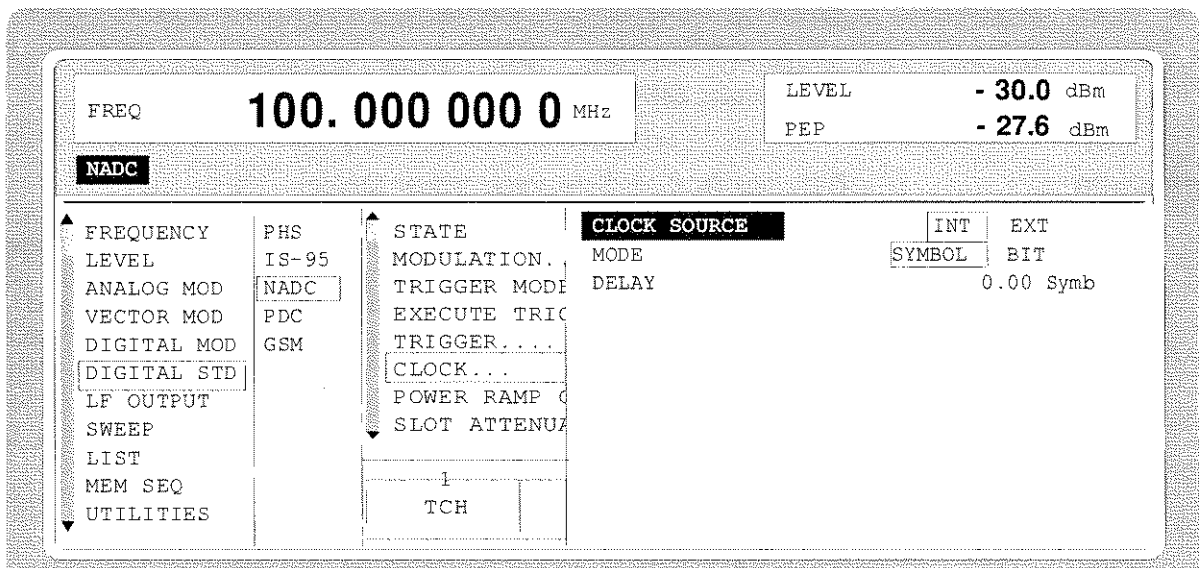

Fig. 2-84 Menu DIGITAL STD - NADC - CLOCK..., SMIQ equipped with Modulation Coder SMIQB10 and Data Generator SMIQB11

- (CLOCK...)** **CLOCK SOURCE** Selection of clock source.
 INT SMIQ uses internally generated clock signals.
 EXT An external symbol clock or bit clock is fed in at connectors SYMBOL CLOCK or BIT CLOCK. The clock synthesizer on the modulation coder is synchronized to this clock.
 The symbol rate has to be set with an accuracy of ± 1 %.
 The polarity, the trigger threshold and the input resistance of the clock inputs can be modified in menu DIGITAL MOD - EXT INPUTS.
 IEC/IEEE-bus command : SOUR:NADC:CLOC:SOUR INT
- MODE** Selection of clock for external clock signal.
 SYMBOL The external clock has to be a symbol clock.
 BIT The external clock has to be a bit clock.
 IEC/IEEE-bus command NADC:CLOC:MODE SYMB
- DELAY** Setting the delay of generated modulation signal to an external clock.
 This can be used, for example, for synchronization with a second unit to achieve time synchronization between the modulation signals of the two units.
 IEC/IEEE-bus command : SOUR:NADC:CLOC:DEL 0.5
- POWER RAMP CONTROL...** Opens a window for setting the envelope control, especially for the rising and falling ramp at the beginning and end of a slot.

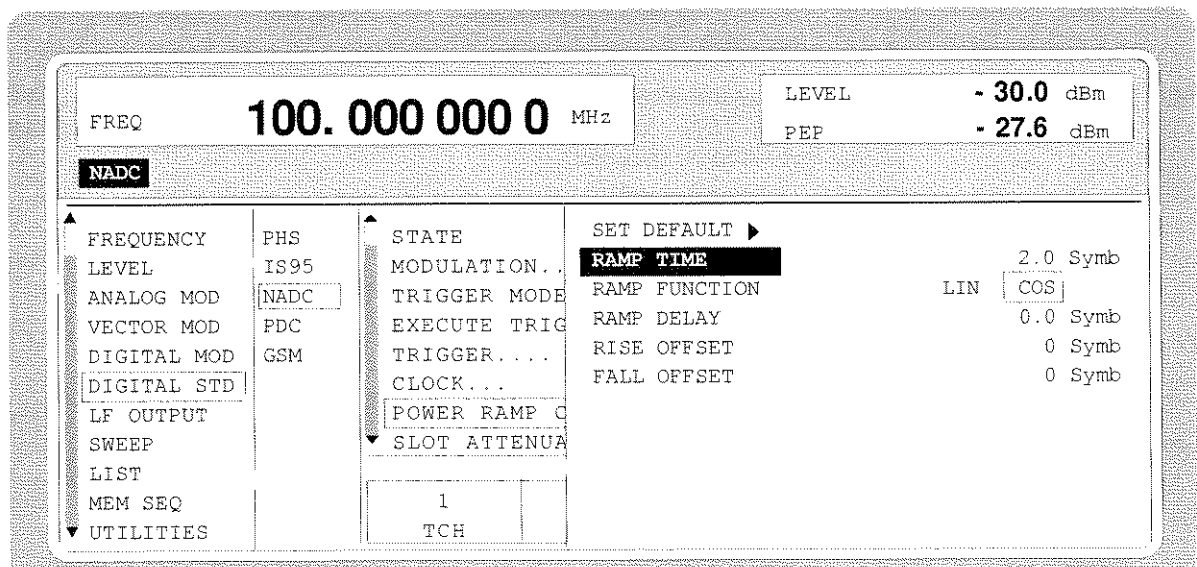

Fig. 2-85 Menu DIGITAL STD - NADC - POWER RAMP CONTROL... , SMIQ equipped with Modulation Coder SMIQB10 and Data Generator SMIQB11

(POWER RAMP CONTROL...)	SET DEFAULT ►	Resets the subsequent parameters to the factory-set values. IEC/IEEE-bus : SOUR : NADC : PRAM : PRES
	RAMP TIME	Input value for the rise and fall time of the envelope at the beginning or end of a slot. The time is set in units of symbol period. IEC/IEEE-bus : SOUR : NADC : PRAM : TIME 0.25
	RAMP FUNCTION	Selection of shape of rising and falling ramp for envelope control. LIN Linear ramp function. COS Cosine function. A more favourable spectrum than that of the LIN function is obtained. IEC/IEEE-bus : SOUR : NADC : PRAM : SHAP LIN
	RAMP DELAY	Input value for a shift of the envelope characteristic to the modulated signal. A positive value causes a delay of the envelope. The values are set in the units of the symbol length. IEC/IEEE-bus SOUR : NADC : PRAM : DEL 0.1
	RISE OFFSET	Input value for a positive or negative offset of the rising ramp of the envelope at the beginning of a slot. IEC/IEEE-bus : SOUR : NADC : PRAM : ROFF -1
	FALL OFFSET	Input value for a positive or negative offset of the falling ramp of the envelope at the end of a slot. IEC/IEEE-bus : SOUR : NADC : PRAM : LOFF 1
SLOT ATTENUATION	Input value for the level reduction in dB of all active slots whose SLOT LEVEL was set to ATTEN. Menu SELECT SLOT allows the slots to be determined whose level is to be reduced. IEC/IEEE-bus command : SOUR : NADC : SLOT : ATT 40 DB	

SAVE/RCL FRAME... Opens a window for saving and loading a frame configuration. Loading a frame affects all parameters that can be set under SELECT SLOT.

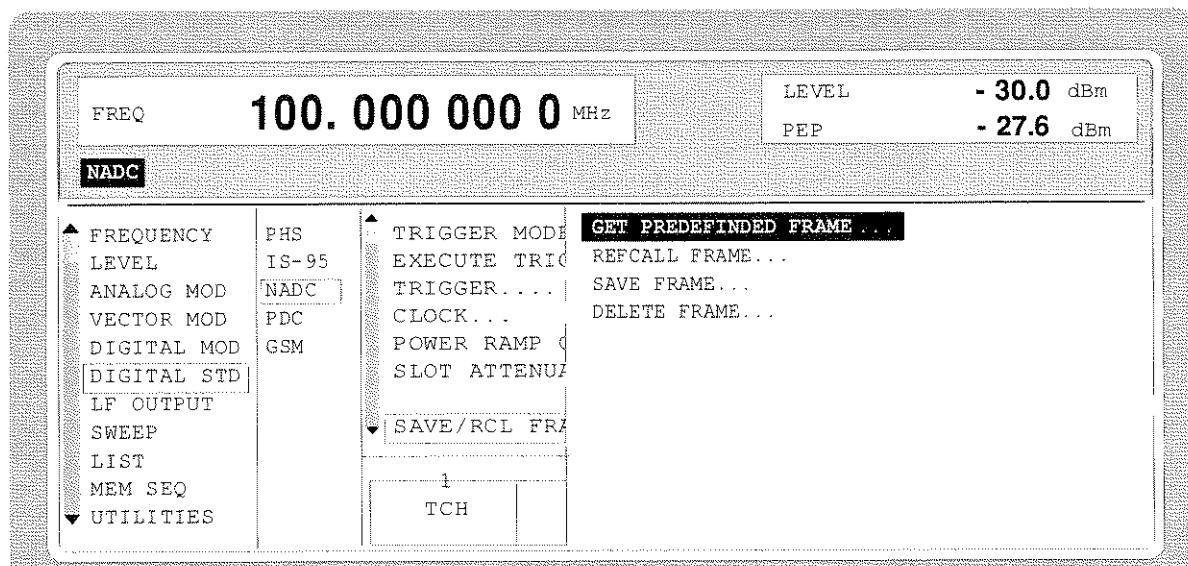

Fig. 2-86 Menu DIGITAL STD - NADC - SAVE/RCL FRAME, SMIQ equipped with Modulation Coder SMIQB10 and Data Generator SMIQB11

(SAVE/RCL FRAME...)	GET PREDEFINED FRAME...	Loads a factory-set frame configuration. DN_TCH Downlink traffic channels in all slots. UP1_TCH Uplink traffic channels in slot 1 IEEE : SOUR:NADC:FLIS:PRED:LOAD "dn_tch"
	RECALL FRAME	Loads a frame configuration saved by the user. IEC/IEEE-bus : SOUR:NADC:FLIS:LOAD "name"
	SAVE FRAME	Saves a user-defined frame configuration. IEC/IEEE-bus : SOUR:NADC:FLIS:STOR "name"
	DELETE FRAME	Deletes a frame configuration saved by the user. IEC/IEEE-bus : SOUR:NADC:FLIS:DEL "name"
LINK DIRECTION	Selection between UPLINK and DOWNLINK. Depending on this selection, various burst types are offered under SELECT SLOT. IEC/IEEE-bus command : SOUR:NADC:LINK UP	

RATE CONFIGURATION...

Opens a window for determining which slots in the frame are to be configured as half-rate and full-rate channels. Full-rate channels occupy two slots in a frame, the second slot is fully determined by the configuration of the first slot. The following eight combinations can be selected:

Selection	Full-rate slots	Half-rate slots
ALL HALF	-	1, 2, 3, 4, 5, 6
FULL 1	1 + 4	2, 3, 5, 6
FULL 2	2 + 5	1, 3, 4, 6
FULL 3	3 + 6	1, 2, 4, 5
FULL 1+2	1 + 4 and 2 + 5	3, 6
FULL 1+3	1 + 4 and 3 + 6	2, 5
FULL 2+3	2 + 5 and 3 + 6	1, 4
ALL FULL	1 + 4 and 2 + 5 and 3 + 6	-

IEC/IEEE-bus command : SOUR:NADC:RCON AHAL

SELECT SLOT...

Selection of one of 6 possible slots. The number depends on the setting under RATE CONFIGURATION. When selecting the slot, a window is opened in which the data contents belonging to this slot can be defined. The content of the window depends on whether an UPLINK or DOWNLINK was selected under LINK DIRECTION.

Note: If the cursor is placed onto a slot in the diagram, it may be switched on and off by pressing one of the unit keys (toggle function).

Selection: BURST TYPE = TCH

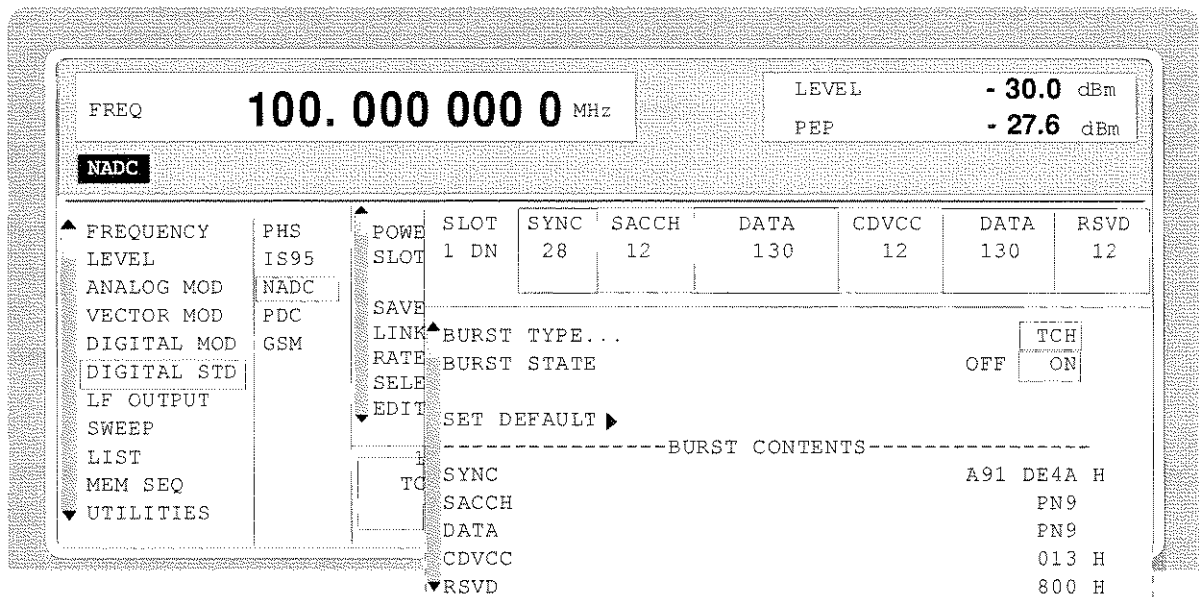

Fig. 2-87 Menu DIGITAL STD - NADC - SELECT SLOT, LINK DIRECTION = DOWNLINK, SMIQ equipped with Modulation Coder SMIQB10 and Data Generator SMIQB11

(SELECT SLOT...) TCH	BURST TYPE	Selection of burst type used to configure the selected slot. TCH Traffic channel burst IEC/IEEE-bus : SOUR:NADC:SLOT2:TYPE TCH
(UPLINK only)	SLOT LEVEL	Selection of level for selected slot. OFF Maximum attenuation IEC/IEEE : SOUR:NADC:SLOT2:LEV OFF FULL The level corresponds to the value indicated on the SMIQ LEVEL display. IEC/IEEE : SOUR:NADC:SLOT2:LEV FULL ATTEN The level is reduced by the value set under SLOT ATTENUATION. IEC/IEEE : SOUR:NADC:SLOT2:LEV ATT
(DOWNLINK only)	BURST STATE	Substitute for parameter SLOT LEVEL for DOWNLINK. ON The burst contents defined in the data fields are sent in the selected slot. IEC/IEEE-bus : SOUR:NADC:SLOT2:LEV FULL OFF Only 1s will be sent. IEC/IEEE-bus : SOUR:NADC:SLOT2:LEV OFF Parameter SLOT LEVEL is omitted since the NADC base station in downlink always sends with the same power in each slot.
	SET DEFAULT ►	Resets the subsequent parameters to the factory-set values. IEC/IEEE-bus command : SOUR:NADC:SLOT8:PRES
(UPLINK only)	G	Display of data contents in the 6 bit data field "Guard" in hexadecimal form.
(UPLINK only)	R	Display of data contents in the 6 bit data field "Ramp".
DATA		Selection of data source for DATA fields. These fields are regarded as a continuous field, ie a pseudo-random sequence is fully continued from one DATA field to the next. The following data sources are available: PN.. PRBS data according to CCITT with periods between 2^9-1 and $2^{23}-1$. IEEE : SOUR:NADC:SLOT3:DATA PN15 DLIST Data from a programmable data list. IEEE : SOUR:NADC:SLOT3:DATA DLIS SERDATA Data from data input SER DATA. IEEE : SOUR:NADC:SLOT3:DATA SDAT

**(SELECT SLOT...) SYNC
TCH)**

Input value for the 28 bit sync word in hexadecimal form. Depending on the selected slot, the following sync words are predefined according to the NADC standard:

- SLOT 1 A91DE4A
- SLOT 2 A9D127A
- SLOT 3 C7E3C0C
- SLOT 4 342C3F3
- SLOT 5 13E23D1
- SLOT 6 DC2EC1D

IEC/IEEE-bus : SOUR:NADC:SLOT2:SYNC A91EE4A

SACCH

Selection of data source for SACCH field (Slow Associated Control Channel).

PN.. PRBS data according to CCITT with periods between 2^9-1 and $2^{23}-1$.

IEEE : SOUR:NADC:SLOT3:SACC PN15

DLIST Data from a programmable data list.

IEEE : SOUR:NADC:SLOT3:SACC DLIS

SERDATA Data from data input SER DATA.

IEEE : SOUR:NADC:SLOT3:SACC SDAT

CDVCC

Input value for the 12 bit "Coded digital verification color code" field in hexadecimal form. SMIQ does not perform any coding but directly accepts the input data. 013 hex. is preset. This corresponds to a value of 1 for the uncoded colour code DVCC.

IEC/IEEE-bus : SOUR:NADC:SLOT2:CDVC #HFFF

**RSVD
(DOWNLINK only)**

Input value for the 12 bit "Reserved" field in hexadecimal form.

IEC/IEEE-bus : SOUR:NADC:SLOT2:CDVC #HFFF

Selection: BURST TYPE = ALL_DATA

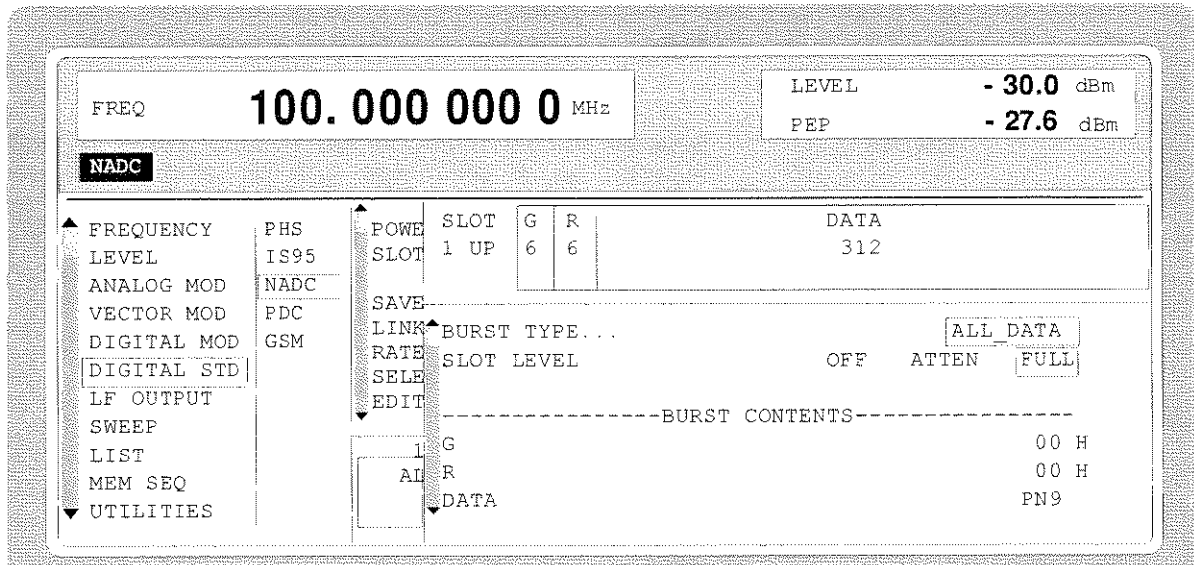

Fig. 2-88 Menu DIGITAL STD - NADC - SELECT SLOT, LINK DIRECTION = UPLINK, SMIQ equipped with Modulation Coder SMIQB10 and Data Generator SMIQB11

<p>(SELECT SLOT...) ALL_DATA</p>	<p>BURST TYPE</p>	<p>Selection of burst type used to configure the selected slot.</p> <p>ALL DATA Burst type for testing with freely programmable data contents</p> <p>IEC/IEEE-bus : SOUR:NADC:SLOT2:TYPE ADAT</p>
<p>SLOT LEVEL (UPLINK only)</p>	<p>SLOT LEVEL</p>	<p>Selection of level for selected slot.</p> <p>OFF Maximum attenuation</p> <p>IEC/IEEE : SOUR:NADC:SLOT2:LEV OFF</p> <p>FULL The level corresponds to the value indicated on the SMIQ LEVEL display.</p> <p>IEC/IEEE : SOUR:NADC:SLOT2:LEV FULL</p> <p>ATTEN The level is reduced by the value set under SLOT ATTENUATION.</p> <p>IEC/IEEE : SOUR:NADC:SLOT2:LEV ATT</p>
<p>BURST STATE (DOWNLINK only)</p>	<p>BURST STATE</p>	<p>Substitute for parameter SLOT LEVEL for LINK DIRECTION = DOWNLINK.</p> <p>ON The burst contents defined in the data fields are sent in the selected slot.</p> <p>IEC/IEEE-bus : SOUR:NADC:SLOT2:LEV FULL</p> <p>OFF Only 1s will be sent.</p> <p>IEC/IEEE-bus : SOUR:NADC:SLOT2:LEV OFF</p> <p>Parameter SLOT LEVEL is omitted since the NADC base station in downlink always sends with the same power in each slot.</p> <p>IEC/IEEE-bus command : SOUR:NADC:SLOT2:LEV FULL</p>

G
(UPLINK only)

Display of data contents in the 6 bit data field "Guard" in hexadecimal form.

R
(UPLINK only)

Display of data contents in the 6 bit data field "Ramp".

DATA

Selection of data source for DATA fields. These fields are regarded as a continuous field, ie a pseudo-random sequence is fully continued from one DATA field to the next. The following data sources are available:

PN.. PRBS data according to CCITT with periods between 2^9-1 and $2^{23}-1$.

IEEE : SOUR:NADC:SLOT3:DATA PN15

DLIST Data from a programmable data list.

IEEE : SOUR:NADC:SLOT3:DATA DLIS

SERDATA Data from data input SER DATA.

IEEE : SOUR:NADC:SLOT3:DATA SDAT

Selection BURST TYPE = SHORT (only available with LINK DIRECTION = UPLINK)

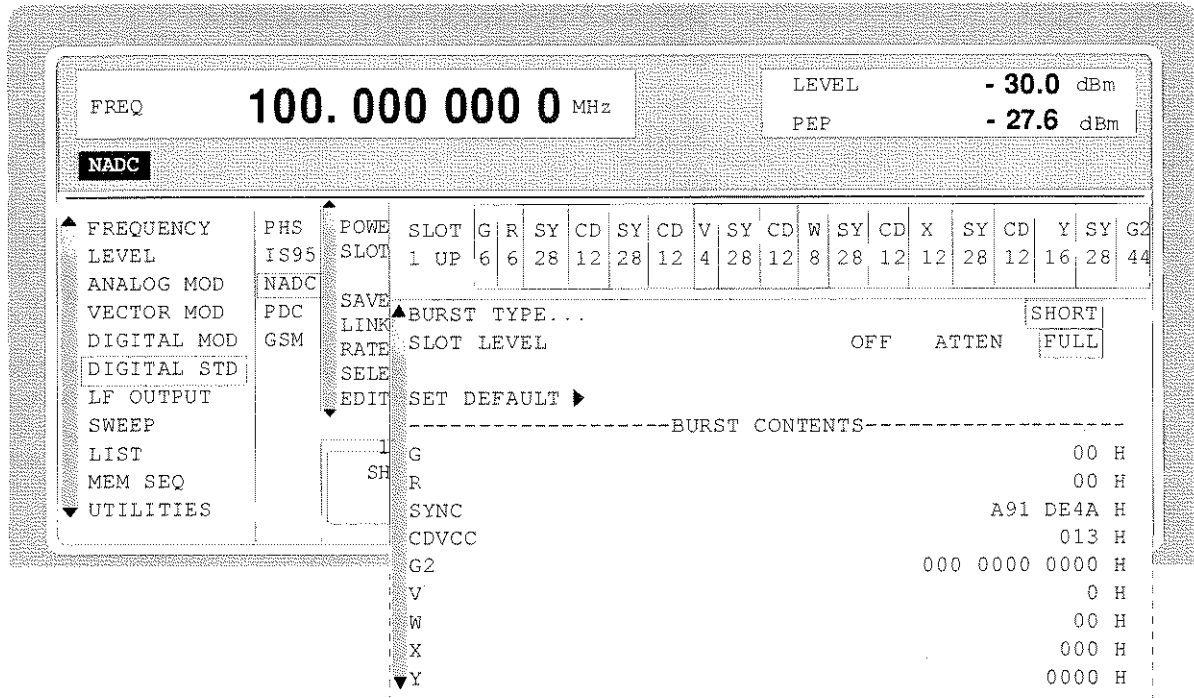

Fig. 2-89 Menu DIGITAL STD - NADC - SELECT SLOT, SMIQ equipped with Modulation Coder SMIQB10 and Data Generator SMIQB11

- (SELECT SLOT...)** **BURST TYPE** Selection of burst type used to configure the selected slot.

SHORT SHORT Shortened Burst

(UPLINK ONLY) IEC/IEEE-bus : SOUR:NADC:SLOT2:TYPE SHOR

- SLOT LEVEL** Selection of level for selected slot.

OFF Maximum attenuation

 IEC/IEEE : SOUR:NADC:SLOT2:LEV OFF

FULL The level corresponds to the value indicated on the SMIQ LEVEL display.

 IEC/IEEE : SOUR:NADC:SLOT2:LEV FULL

ATTEN The level is reduced by the value set under SLOT ATTENUATION.

 IEC/IEEE : SOUR:NADC:SLOT2:LEV ATT

- SET DEFAULT** ► Resets the subsequent parameters to the factory-set values.

 IEC/IEEE-bus command : SOUR:NADC:SLOT8 PRES

- G** Display of data contents in the 6 bit data field "Guard" in hexadecimal form.

- R** Display of data contents in the 6 bit data field "Ramp".

**(SELECT SLOT...) SYNC
UPLINK SHORT
(UPLINK ONLY)**

Input value for the sync word in hexadecimal form. Depending on the selected slot, the following sync words are predefined according to the NADC standard:

SLOT 1 A91DE4A
SLOT 2 A9D127A
SLOT 3 C7E3C0C
SLOT 4 342C3F3
SLOT 5 13E23D1
SLOT 6 DC2EC1D

IEC/IEEE-bus : SOUR:NADC:SLOT2:SYNC A91EE4A

D

Input value for the 12 bit "Coded digital verification color code" field in hexadecimal form. SMIQ does not perform any coding but directly accepts the input data. 013 hex. is preset. This corresponds to a value of 1 for the uncoded colour code DVCC.

IEC/IEEE-bus : SOUR:NADC:SLOT2:CDVC #HFFF

V, W, X, Y

Display of data contents of other data fields that are predefined by the NADC standard.

G2

Display of data contents in the second "Guard" in hexadecimal form.

2.14 Digital Standard PDC

With the options Modulation Coder (SMIQB10) and Data Generator (SMIQB11) provided, modulation signals according to the Japanese PDC standard¹ can be generated. PDC is a TDMA standard for cellular mobile radio networks.

SMIQ can generate both the transmit signal of a base station (BS) and the transmit signal of a mobile station (MS). Transmission from BS to MS is called "downlink", "uplink" being used for transmission in the opposite direction.

Each TDMA frame consists of 6 slots. The 6 slots can be configured for both full rate and half rate mode. For half rate, the data content for each of the 6 slots can be defined separately by means of a slot editor whereas in the full rate mode 2 slots for example slot 1 and 4 are combined in a frame. The settings for the first slot are then automatically used for the assigned second slot. Each slot can be switched on or off. Moreover, a defined intermediate level can be set for uplink slots.

A burst type has to be defined to configure a slot. The following burst types can be selected:

- TCH a traffic channel burst with a different structure for uplink and downlink,
- SYNC a burst type for simulation of a sync channel,
- VOX a burst type which is only available in uplink for simulating a communication channel in speech intervals,
- ALL_DATA burst type for test purposes with freely programmable data contents in the selected slot.

For TCH and VOX bursts, SMIQ supports the generation of superframes with a length of 18 frames. The frame position of the so-called "housekeeping channel" RCH can be set in the superframe. According to the standard, the beginning of the superframe is marked by a special sync word in the SYNC data field of the first slot.

The following internal modulation sources are available:

- different PRBS generators with a sequence length between 2^9-1 and $2^{23}-1$ and
- data lists, ie freely programmable data sequences from the data generator memory.

For generating the PDC signals, SMIQ inserts the modulation data continuously (in real time) into the selected slots. Using a digital signal processor the data generator generates a data sequence with modulation data and control signals for envelope control.

The data generator in SMIQ generates a data stream which is converted into IQ signals in the modulation coder. According to the PDC standard, the modulation type is $\pi/4$ DQPSK at a symbol rate of 21 ksymbol/s and $\sqrt{\text{COS}}$ filtering. Symbol rate and filtering can be changed in SMIQ.

¹ Personal Digital Cellular Telecommunication System, RCR STD-27 D

2.14.1 Sync and Trigger Signals

The data generator generates a data sequence with modulation data, control signals for envelope control, and synchronization signals.

When TRIGGER MODE AUTO is selected, the PDC signal generation is started automatically.

This start can also be activated by an external trigger signal (TRIGGER MODE ARMED_AUTO) which allows a synchronous sequence for BER measurements to be carried out on receivers.

A trigger signal can be fed via the TRIGIN input at connector PAR DATA. The active slope of a trigger signal applied there executes a trigger event.

PDC signal generation at a frame or a super frame limit is started after a trigger event. Data from data lists are inserted into the selected slots starting from the first bit. PRBS generators start with the set initialization status.

Signal generation either starts immediately after the active slope of the trigger signal or after a settable number of symbols (EXT TRIGGER DELAY). Retriggerring (RETRIG) can be inhibited for a settable number of symbols (EXT RETRIGGER INHIBIT).

A trigger event can be executed manually or via the IEC/IEEE bus using EXECUTE TRIGGER.

When a trigger event is executed, a trigger signal is output at the TRIGOUT 3 output of SMIQ.

SMIQ also generates the following sync signals:

- a frame clock at TRIGOUT 1 output,
- a frame or multiframe clock at TRIGOUT 2 output with settable position in the frame,
- the symbol clock and the bit clock.

A clock synthesizer on the modulation coder generates the symbol clock and the bit clock in SMIQ. All the clock signals are synchronized to the 10-MHz reference of SMIQ. The symbol clock is available at connector SYMBOL CLOCK and the bit clock at connector BIT CLOCK. If required, the clock synthesizer in SMIQ can be synchronized to an external symbol or bit clock.

The clock signal is selected in the menu via CLOCK-CLOCK SOURCE EXT.

To allow for a trouble-free synchronization of the clock synthesizer first apply the external clock and set the correct symbol rate at SMIQ. Then switch CLOCK SOURCE from INT to EXT.

Note: *The set symbol rate should not differ by more than 1% from the symbol rate of the external signal.*

2.14.2 PN Generators as Internal Data Source

Independent PN generators (Pseudo Noise) can be selected for each slot as data source for data fields DATA, SACCH, RCH and SI. These PN generators provide pseudo-random bit sequences of different length or period. That is why they are also called PRBS generators (Pseudo Random Binary Sequence). Data sequences are sequences of maximum length which are generated by means of feedback shift registers.

The following figure gives an example of a 9 bit generator with feedbacks after register 4 and 0 (output).

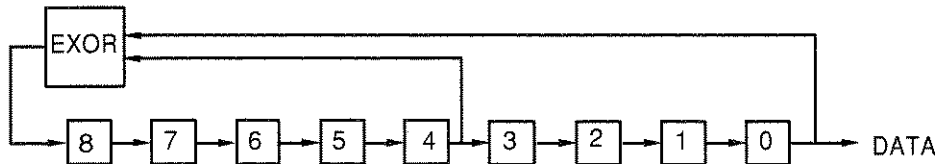

The pseudo-random sequence of a PRBS generator is clearly defined by the number of registers and the feedback. The following table describes all PRBS generators available:

Table 2-18 PRBS generators for PDC

PRBS generator	Length in bits	Feedback after
9 bit	$2^9 - 1 = 511$	Register 4, 0
11 bit	$2^{11} - 1 = 2047$	Register 2, 0
15 bit	$2^{15} - 1 = 32767$	Register 1, 0
16 bit	$2^{16} - 1 = 65535$	Register 5, 3, 2, 0
20 bit	$2^{20} - 1 = 1048575$	Register 3, 0
21 bit	$2^{21} - 1 = 2097151$	Register 2, 0
23 bit	$2^{23} - 1 = 8388607$	Register 5, 0

PN generators PN9,11,15,20 and PN23 are configured according to CCITT Rec. 0.151/152/153. The output sequence is inverted for generators PN15 and PN23.

The start value of the PN generators is different in the slots and equals

$$\text{start value} = 1 + 14 \text{ hex} \times \text{slot number}$$

Example: PN9 generator in slot 1 with start value 15hex = 10101 binary.

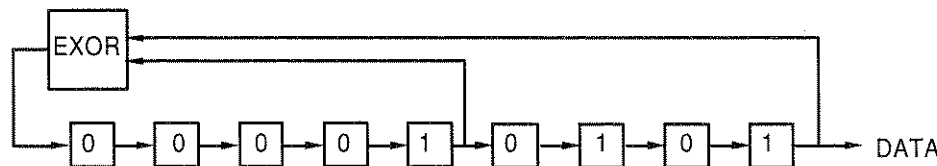

The resulting output sequence is 1010100000010100101011110010 etc.

2.14.3 Lists as Internal Data Source

A freely programmable memory on the data generator serves as internal data source for the data fields of the slots. The data are managed in so-called lists. A list editor allows to select, copy, modify and delete data lists (DATA LIST).

The list editor is available via menu DIGITAL-MOD - SOURCE....

2.14.4 External Modulation Data

External data can (only) be applied via the SERDATA interface. A selection of SERDATA as data source is only possible for a single data field of a slot. For further information on the characteristics of the SERDATA interface see Annex A.

To ensure that the external data bits are assigned to specific positions in the data field of the selected slot and that they are reproducible, the buffer of the RS-232 transmitter and receiver has to be deleted. A triggered start has to follow.

The following setting sequence is required in the DIGITAL STD - PDC menu:

1. Carry out desired settings in menu.
2. Select data source SERDATA for the data field of the slot using SELECT SLOT -
3. Make connection to external data source, but do not yet start external data source.
4. Switch off digital standard using STATE - OFF.
5. Set TRIGGER MODE ARMED_AUTO.
In this state, SMIQ is ready for reception, but discards data that are read in via SERDATA.
6. Switch on digital standard with STATE ON.
7. Start external data source.
The read-in data are written into the receiving buffer. Only if this buffer is filled can SMIQ react to a trigger event.
8. Activate trigger event. Signal generation is thus started at a frame limit. The first bit received via SERDATA is put to the first bit position in the selected data field.

2.14.5 Menu DIGITAL STANDARD - PDC

Menu DIGITAL STD - PDC provides access to settings for generating PDC signals.

Menu selection: DIGITAL STD - PDC

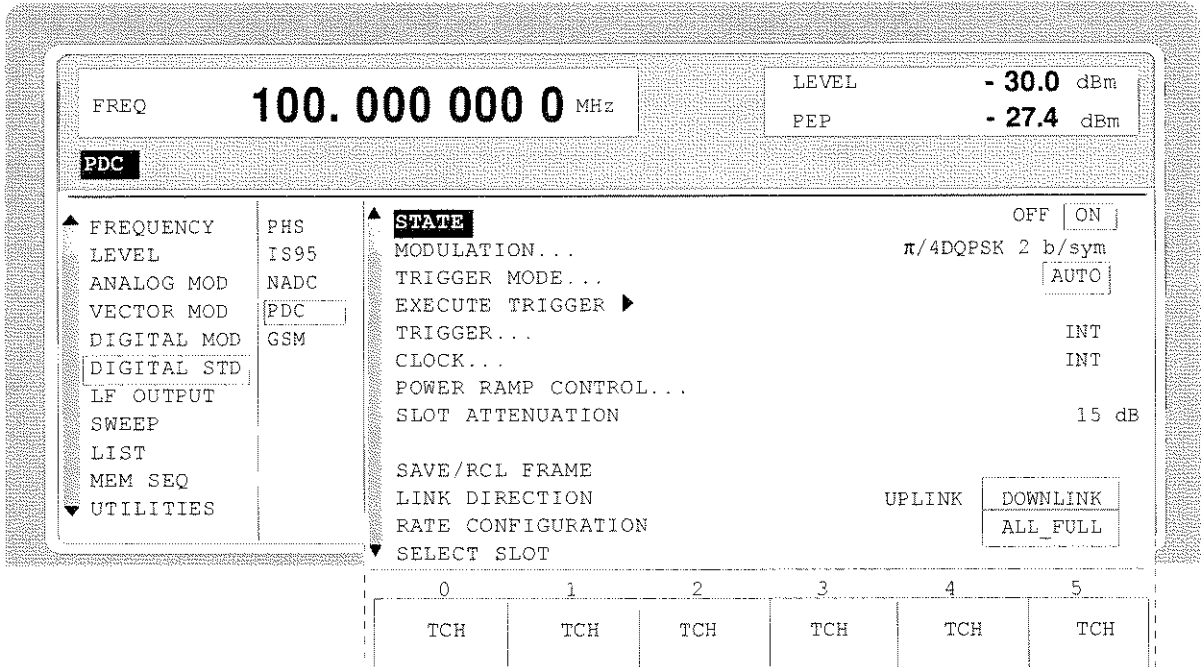

Fig. 2-90 Menu DIGITAL STD - PDC, SMIQ equipped with Modulation Coder SMIQB10 and Data Generator SMIQB11

STATE Switch on/off of Digital Standard PDC modulation. Vector Modulation or Digital Modulation will be switched off automatically.

IEC/IEEE-bus command SOUR:PDC:STAT ON

MODULATION... Opens a window for setting the modulation parameters.

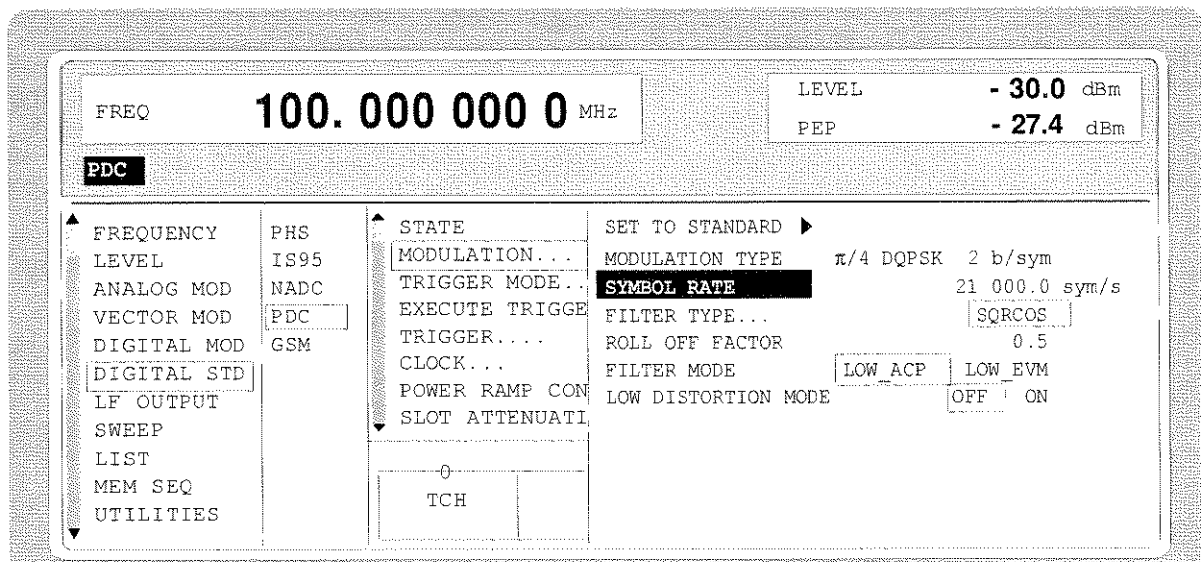

Fig. 2-91 Menu DIGITAL STD - PDC - MODULATION..., SMIQ equipped with Modulation Coder SMIQB10 and Data Generator SMIQB11

(MODULATION...)	SET TO STANDARD ►	Sets the subsequent modulation parameters to the values predefined by the standard.
	MODULATION TYPE	Displays the modulation type.
	SYMBOL RATE	Input value for the symbol clock. 21 ksymbol/s are preset. IEC/IEEE-bus SOUR:PDC:SRAT 21.1KHZ
	FILTER	Selection of baseband filter. A selection between Nyquist filters COS and SQR COS is possible. IEC/IEEE-bus SOUR:PDC:FILT:TYPE COS
	ROLL OFF FACTOR	Input value for the roll-off factor. IEC/IEEE-bus SOUR:PDC:FILT:PAR 0.51
	FILTER MODE	Selection of filter mode. LOW_ACP Filter for minimum <u>A</u> djacent <u>C</u> hannel <u>P</u> ower. IEC : SOUR:PDC:FILT:MODE LACP LOW_EVM Filter for minimum vector error. IEC : SOUR:PDC:FILT:MODE LEVM
	LOW DISTORTION	Switch on/off of low-distortion mode.. After switch-on, the level of the IQ baseband signals is reduced by 3 dB. In some cases, this might reduce undesired intermodulation products. OFF is normally the more favourable setting. IEC/IEEE-bus command SOUR:PDC:LDIS OFF
TRIGGER MODE...		Opens a window for selecting the trigger mode.
	AUTO	The PDC signals are continuously transmitted in the activated slots. IEC/IEEE-bus : SOUR:PDC:SEQ AUTO
	RETRIG	The PDC signals are continuously transmitted in the activated slots. A trigger event causes a restart. IEC/IEEE-bus : SOUR:PDC:SEQ RETR
	ARMED_AUTO	The PDC signal generation does not start until a trigger event has occurred. The unit then automatically switches over to the AUTO mode and can no longer be triggered. IEC/IEEE-bus : SOUR:PDC:SEQ AAUT
	ARMED_RETRIG	The PDC signal generation does not start until a trigger event has occurred. The unit then automatically switches over to the RETRIG mode. Each new trigger event causes a restart. IEC/IEEE-bus : SOUR:PDC:SEQ ARET
EXECUTE TRIGGER ►		Executes a trigger even to start the PDC signal generation. IEC/IEEE-bus command : TRIG:DM IMM

TRIGGER...

Opens a window for selecting the trigger source, for configuring the trigger output signals and for setting the time delay of an external trigger signal.

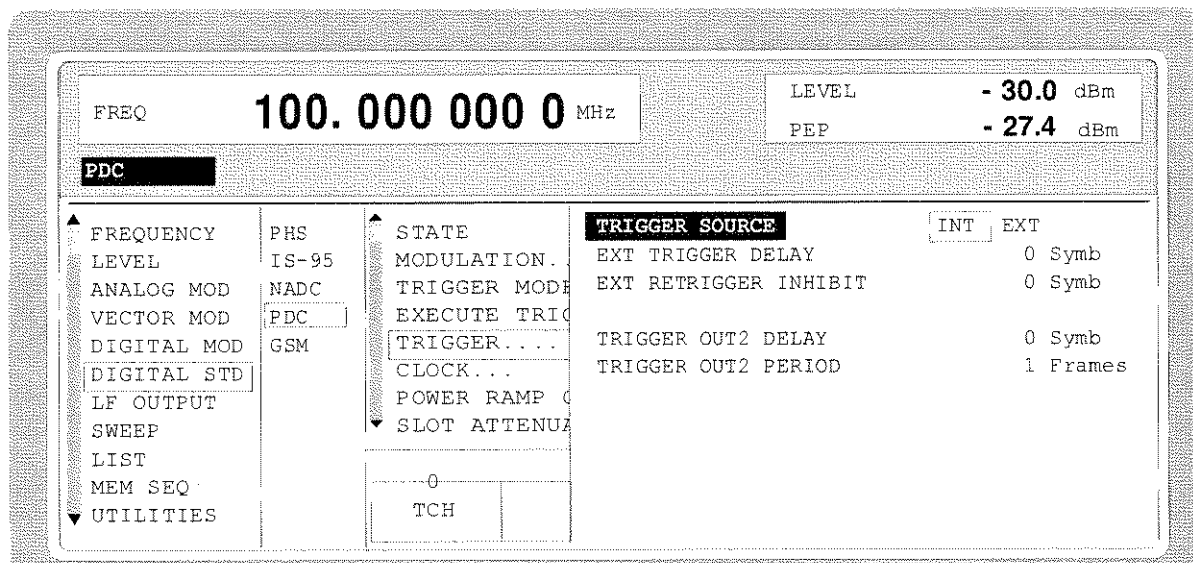

Fig. 2-92 Menu DIGITAL STD - PDC_TRIGGER..., SMIQ equipped with Modulation Coder SMIQB10 and Data Generator SMIQB11

(TRIGGER...)**TRIGGER SOURCE**

Selection of trigger source.

EXT The PDC signal generation is started by the active slope of an external trigger signal. The polarity, the trigger threshold and the input resistance of the TRIGIN input can be modified in menu DIGITAL MOD - EXT INPUTS.

INT A trigger event is executed by EXECUTE TRIGGER ►.

IEC/IEEE-bus SOUR:PDC:TRIG:SOUR EXT

EXT TRIGGER DELAY

Setting the number of symbols by which an external trigger signal is delayed before it starts the PDC signal generation.

This is used for setting the time synchronization between the SMIQ and the DUT.

IEC/IEEE-bus SOUR:PDC:TRIG:DEL 3

EXT RETRIGGER INHIBIT

Setting the number of symbols for which a restart is inhibited after a trigger event.

With TRIGGER MODE RETRIG selected, each new trigger signal restarts the PDC signal generation. This restart can be inhibited for the entered number of symbols.

Example:

The entry of 1000 symbols causes new trigger signals to be ignored for the duration of 1000 symbols after a trigger event

IEC/IEEE-bus SOUR:PDC:TRIG:INH 1000

- (TRIGGER...) **TRIGGER OUT 2 DELAY** Input value of delay of trigger signal at TRIGOUT 2 output compared with beginning of frame.
IEC/IEEE-bus SOUR:PDC:TRIG:OUTP:DEL 2
- TRIGGER OUT2 PERIOD** Input value of output signal period at TRIGOUT 2 output given in frames.
IEC/IEEE-bus SOUR:PDC:TRIG:OUTP:PER 1

CLOCK... Opens a window for selecting the clock source and for setting a delay.

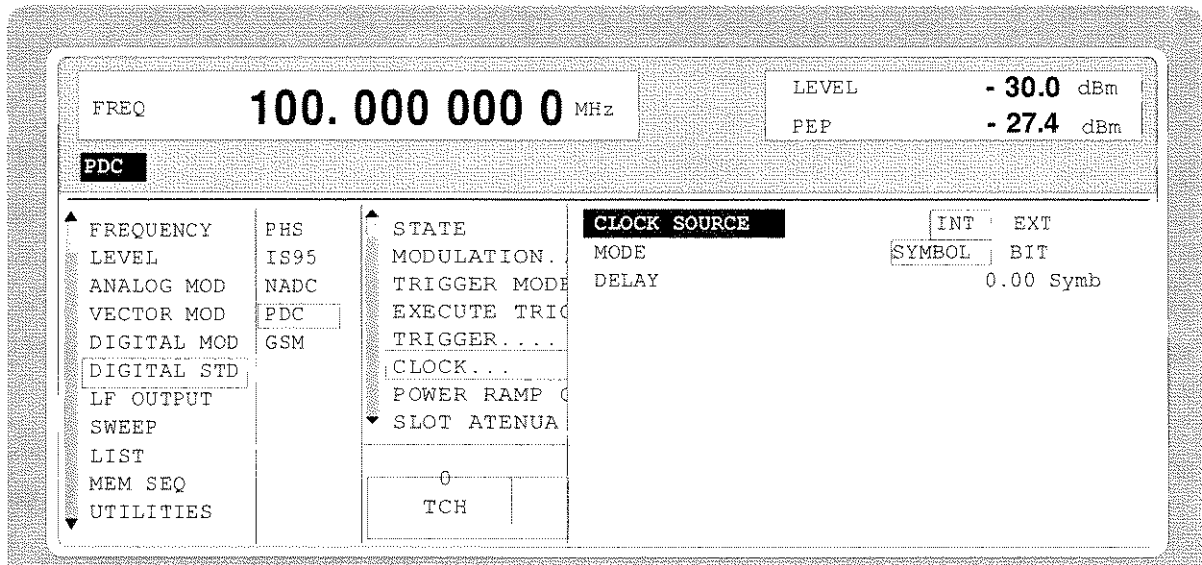

Fig. 2-93 Menu DIGITAL STD - PDC - CLOCK..., SMIQ equipped with Modulation Coder SMIQB10 and Data Generator SMIQB11

- (CLOCK...) **CLOCK SOURCE** Selection of clock source.
INT SMIQ uses internally generated clock signals.
EXT An external symbol clock or bit clock is fed in at connectors SYMBOL CLOCK or BIT CLOCK. The clock synthesizer on the modulation coder is synchronized to this clock.
 The symbol rate has to be set with an accuracy of $\pm 1\%$.
 The polarity, the trigger threshold and the input resistance of the clock inputs can be modified in menu DIGITAL MOD - EXT INPUTS.
IEC/IEEE-bus command SOUR:PDC:CLOC:SOUR INT
- MODE** Selection of clock for external clock signal.
SYMBOL The external clock has to be a symbol clock.
BIT The external clock has to be a bit clock.
IEC/IEEE-bus command SOUR:PDC:CLOC:MODE SYMB

(CLOCK...)**DELAY**

Setting the delay of generated modulation signal to an external clock.

This can be used, for example, for synchronization with a second unit to achieve time synchronization between the modulation signals of the two units.

IEC/IEEE-bus command SOUR:PDC:CLOC:DEL 0.5

POWER RAMP CONTROL...

Opens a window for setting the envelope control, especially for the rising and falling ramp at the beginning and end of a slot.

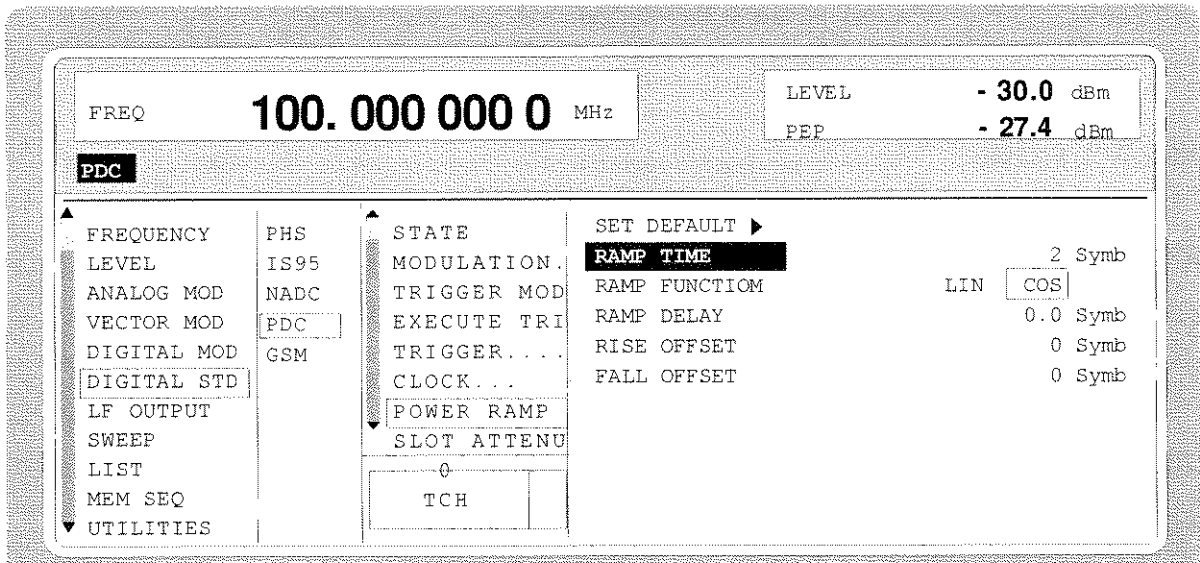

Fig. 2-94 Menu DIGITAL STD - PDC - POWER RAMP CONTROL... , SMIQ equipped with Modulation Coder SMIQB10 and Data Generator SMIQB11

(POWER RAMP CONTROL...)**SET DEFAULT ►**

Resets the subsequent parameters to the factory-set values.

IEC/IEEE-bus : SOUR:PDC:PRAM:PRES

RAMP TIME

Input value for the rise and fall time of the envelope at the beginning or end of a slot. The time is set in units of symbol period.

IEC/IEEE-bus SOUR:PDC:PRAM:TIME 0.25

RAMP FUNCTION

Selection of shape of rising and falling ramp for envelope control.

LIN Linear ramp function.

COS Cosine function. A more favourable spectrum than that of the LIN function is obtained.

IEC/IEEE-bus SOUR:PDC:PRAM:SHAP LIN

RAMP DELAY

Input value for a shift of the envelope characteristic to the modulated signal. A positive value causes a delay of the envelope. The values are set in the units of the symbol length.

IEC/IEEE-bus SOUR:PDC:PRAM:DEL 0.1

(POWER RAMP CONTROL...) **RISE OFFSET** Input value for a positive or negative offset of the rising ramp of the envelope at the beginning of a slot.
IEC/IEEE-bus SOUR:PDC:PRAM:ROFF -1

FALL OFFSET Input value for a positive or negative offset of the falling ramp of the envelope at the end of a slot.
IEC/IEEE-bus SOUR:PDC:PRAM:LOFF 1

SLOT ATTENUATION Input value for the level reduction in dB of all active slots whose SLOT LEVEL was set to ATTEN. Menu SELECT SLOT allows the slots to be determined whose level is to be reduced.
IEC/IEEE-bus command SOUR:PDC:SLOT:ATT 15 DB

SAVE/RCL FRAME... Opens a window for saving and loading a frame configuration. Loading a frame affects all parameters that can be set under SELECT SLOT.

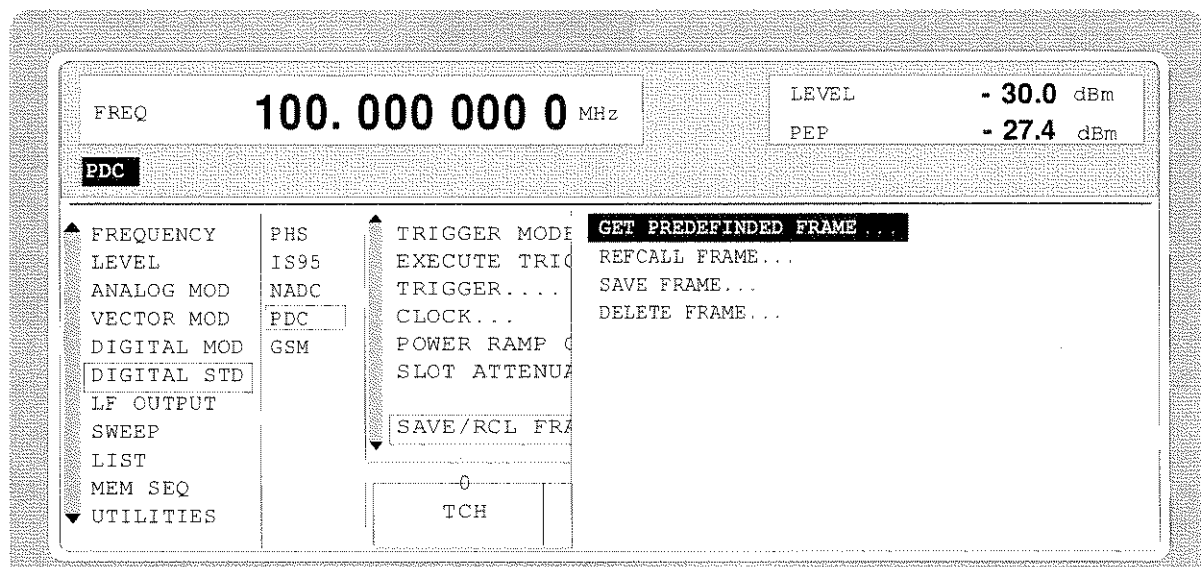

Fig. 2-95 Menu DIGITAL STD - PDC - SAVE/RCL FRAME, SMIQ equipped with Modulation Coder SMIQB10 and Data Generator SMIQB11

(SAVE/RCL FRAME...) GET PREDEFINED FRAME... Loads a factory-set frame configuration.
DN_TCH Downlink traffic channels in all slots.
UP0_TCH Uplink traffic channels in slot 0
IEEE SOUR:PDC:FLIS:PRED:LOAD "dn_tch"

RECALL FRAME... Loads a frame configuration saved by the user.
IEC/IEEE-bus SOUR:PDC:FLIS:LOAD "name"

SAVE FRAME... Saves a user-defined frame configuration.
IEC/IEEE-bus SOUR:PDC:FLIS:STOR "name"

DELETE FRAME... Deletes a frame configuration saved by the user.
IEC/IEEE-bus SOUR:PDC:FLIS:DEL "name"

LINK DIRECTION

Selection between UPLINK and DOWNLINK. Depending on the selection, different burst types are offered under SELECT SLOT.

IEC/IEEE-bus command SOUR:PDC:LINK UP

RATE CONFIGURATION...

Opens a window for determining which slots in the frame are to be configured as half-rate and full-rate channels. Full-rate channels occupy two slots in a frame, the second slot is fully determined by the configuration of the first slot. The following eight combinations can be selected:

Selection	Full-rate slots	Half-rate slots
ALL HALF	keine	0, 1, 2, 3, 4, 5
FULL 1	0 + 3	1, 2, 4, 5
FULL 2	1 + 4	0, 2, 3, 5
FULL 3	2 + 5	0, 1, 3, 4
aL 1+2	0 + 3 and 1 + 4	2, 5
FULL 1+3	0 + 3 and 2 + 5	1, 4
FULL 2+3	1 + 4 and 2 + 5	0, 3
ALL FULL	0 + 3 and 1 + 4 and 2 + 5	none

IEC/IEEE-bus command SOUR:PDC:RCON AHAL

SELECT SLOT...

Selection of one of 6 possible slots. The number depends on the setting under RATE CONFIGURATION. When selecting the slot, a window is opened in which the data contents belonging to this slot can be defined. The content of the window depends on whether an UPLINK or DOWNLINK was selected under LINK DIRECTION.

Note: If the cursor is placed onto a slot in the diagram, it may be switched on and off by pressing one of the unit keys (toggle function).

Selection: BURST TYPE = TCH

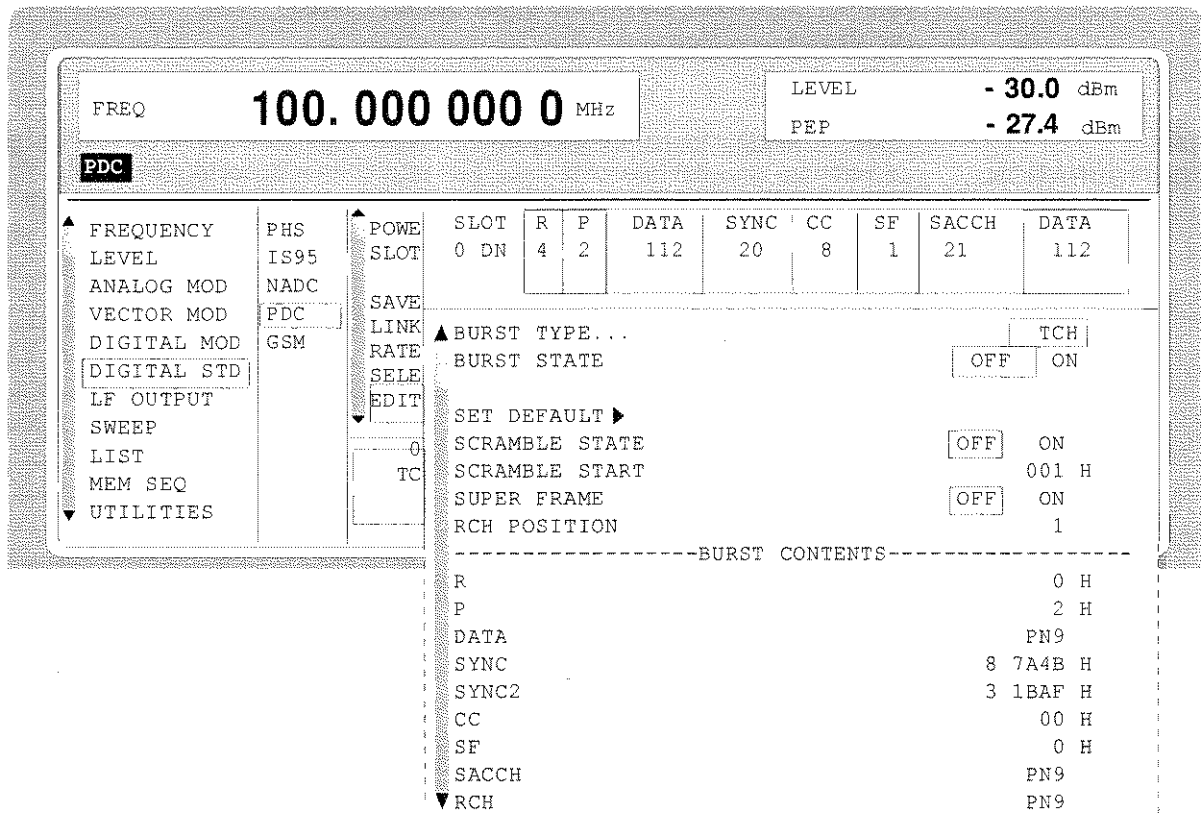

Fig. 2-96 Menu DIGITAL STD - PDC - SELECT SLOT, LINK DIRECTION DOWNLINK, SMIQ equipped with Modulation Coder SMIQB10 and Data Generator SMIQB11

<p>(SELECT SLOT...)</p> <p>BURST TYPE</p> <p>TCH</p>	<p>BURST TYPE</p> <p>TCH Traffic channel burst</p> <p>IEC/IEEE-bus SOUR:PDC:SLOT2:TYPE TCH</p>	<p>Selection of burst type used to configure the selected slot.</p>
<p>SLOT LEVEL</p> <p>(UPLINK only)</p>	<p>OFF Maximum attenuation</p> <p>IEC/IEEE :SOUR:PDC:SLOT2:LEV OFF</p> <p>FULL The level corresponds to the value indicated on the SMIQ LEVEL display.</p> <p>IEC/IEEE :SOUR:PDC:SLOT2:LEV FULL</p> <p>ATTEN The level is reduced by the value set under SLOT ATTENUATION.</p> <p>IEC/IEEE :SOUR:PDC:SLOT2:LEV ATT</p>	<p>Selection of level for selected slot.</p>

(SELECT SLOT...) TCH	BURST STATE (DOWNLINK only)	<p>Substitute for parameter SLOT LEVEL for downlink.</p> <p>ON The burst contents defined in the data fields are sent in the selected slot.</p> <p style="padding-left: 40px;">IEC/IEEE-bus : SOUR:PDC:SLOT2:LEV FULL</p> <p>OFF Only 1s will be sent.</p> <p style="padding-left: 40px;">IEC/IEEE-bus : SOUR:PDC:SLOT2:LEV OFF</p> <p>Parameter SLOT LEVEL is omitted since the NADC base station in downlink always sends with the same power in each slot.</p>
	SET DEFAULT ►	<p>Resets the subsequent parameters to the factory-set values.</p> <p>IEC/IEEE-bus command SOUR:PDC:SLOT8: PRES</p>
	SCRAMBLE	<p>Switch on/off of scrambling function. Scrambling with the continuous scramble sequence from a PN9 generator is applied to the data fields DATA, SF, and SACCH.</p> <p>IEC/IEEE-bus SOUR:PDC:SLOT2:SCR:STAT ON</p>
	SCRAMBLE START	<p>9 bit input value for initializing the scramble PN9 generator in hexadecimal form. The value 0 is not permissible, 1 is preset. The input field is only displayed if SCRAMBLE is switched on.</p> <p>IEC/IEEE-bus SOUR:PDC:SLOT2:SCR:STAR #H12</p>
	SUPERFRAME	<p>Switch on/off of the superframe generation. 18 frames form a superframe. If SUPERFRAME is switched on, RCH data instead of SACCH data will be sent in 2 slots. The first of the two RCH blocks is fixed in the first slot of the superframe, the position of the second can be set.</p> <p>IEC/IEEE-bus SOUR:PDC:SLOT2:SFR:STAT ON</p>
	RCH POSITION	<p>Input value for the position of the second RCH block. The input field is only displayed if SUPERFRAME is switched on.</p> <p>IEC/IEEE-bus SOUR:PDC:SLOT2:SFR:RCHP 10</p>
	R	<p>Display of data contents in the 4 bit data field "RAMP" in hexadecimal form.</p>
	P	<p>Input value of the 2 bit data field "Preamble".</p> <p>IEC/IEEE-bus SOUR:PDC:SLOT2:PRE #H1</p>
	DATA	<p>Selection of data source for DATA fields. These fields are regarded as a continuous field, ie a pseudo-random sequence is fully continued from one DATA field to the next. The following data sources are available:</p> <p>PN.. PRBS data according to CCITT with periods between 2^9-1 and $2^{23}-1$.</p> <p style="padding-left: 40px;">IEC/IEEE : SOUR:PDC:SLOT3:DATA PN15</p> <p>DLIST Data from a programmable data list.</p> <p style="padding-left: 40px;">IEC/IEEE : SOUR:PDC:SLOT3:DATA DLIS</p> <p>SERDATA Data from data input SER DATA.</p> <p style="padding-left: 40px;">IEC/IEEE : SOUR:PDC:SLOT3:DATA SDAT</p>

**(SELECT SLOT...) SYNC
TCH**

Input value for the 20 bit sync word in hexadecimal form. Depending on the selected slot the LINK DIRECTION, the following sync words are predefined according to the PDC standard:

Slot No.	Downlink Sync Word	Uplink Sync Word
0	87A4B	785B4
1	9D236	62DC9
2	81D75	7E28A
3	A94EA	56B15
4	5164C	AE9B3
5	4D9DE	B2621

According to the standard, the sync words of the uplink are the inverted sync words of the downlink.

IEC/IEEE-bus SOUR:PDC:SLOT2:SYNC #H62DC8

SYNC2

Input value for the 20 bit sync word in the first slot of a superframe in hexadecimal form. This sync word marks the beginning of the superframe. The input field is only displayed if SUPERFRAME is switched on. Depending on the selected slot and the LINK DIRECTION, the following sync words are predefined according to the PDC standard:

Slot No.	Downlink Sync2 Word	Uplink Sync2 Word
0	31BAF	CE450
1	1E56F	E1A90
2	E712C	18ED3
3	FBC1F	043E0
4	8279E	7D861
5	98908	676F7

According to the standard, the sync words of the uplink are the inverted sync words of the downlink.

IEC/IEEE-bus SOUR:PDC:SLOT2:SYNC #HE2A90

CC

Input value of the 8 bit data field " Color code ".

IEC/IEEE-bus command SOUR:PDC:SLOT2:CCOD #HFF

SF

Input value of the data field " Steal Flag ".

IEC/IEEE-bus command SOUR:PDC:SLOT2:SF #H0

**(SELECT SLOT...) SACCH
TCH**

Selection of data source for SACCH field (Slow Associated Control Channel).

PN.. PRBS data according to CCITT with periods between 2^9-1 and $2^{23}-1$.

IEC/IEEE : SOUR:PDC:SLOT3:SACC PN15

DLIST Data from a programmable data list.

IEC/IEEE : SOUR:PDC:SLOT3:SACC DLIS

SERDATA Data from data input SER DATA.

IEC/IEEE : SOUR:PDC:SLOT3:SACC SDAT

RCH

Selection of data source for the RCH data field. RCH data replace SACCH data in certain slots of a superframe. The input field is only displayed if SUPERFRAME is switched on.

PN.. PRBS data according to CCITT with periods between 2^9-1 and $2^{23}-1$.

IEC/IEEE : SOUR:PDC:SLOT3:RCH PN15

DLIST Data from a programmable data list.

IEC/IEEE : SOUR:PDC:SLOT3:RCH DLIS

SERDATA Data from data input SER DATA.

IEC/IEEE : SOUR:PDC:SLOT3:RCH SDAT

**G
(UPLINK only)**

Display of data content in the 6 bit "Guard" field in hexadecimal form.

Selection: BURST TYPE = ALL_DATA

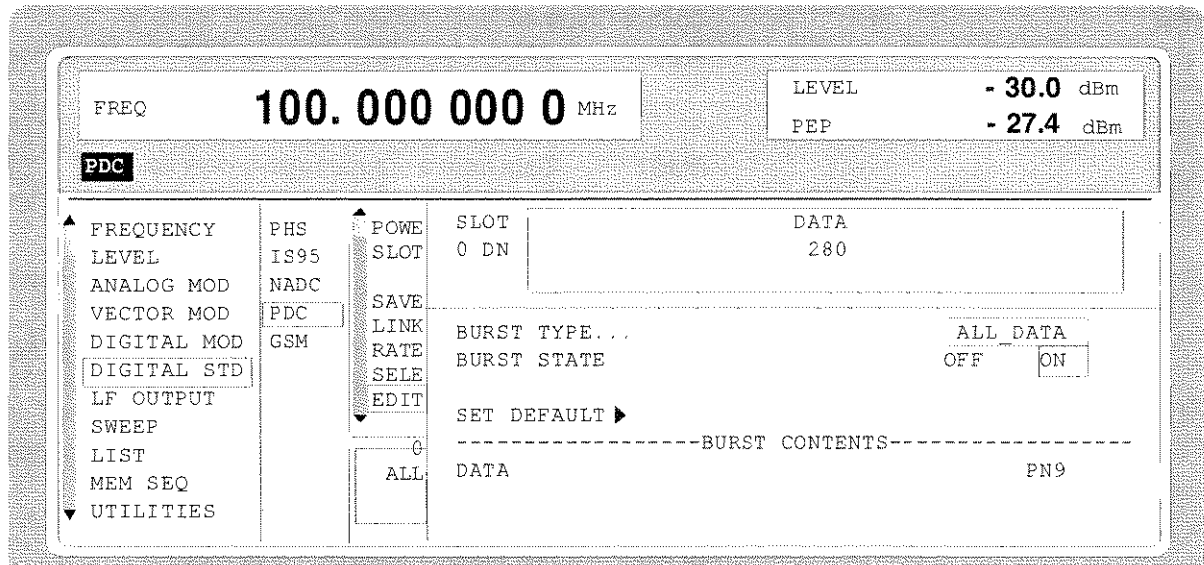

Fig. 2-97 Menu DIGITAL STD - PDC - SELECT SLOT, LINK DIRECTION = DOWNLINK, SMIQ equipped with Modulation Coder SMIQB10 and Data Generator SMIQB11

(SELECT SLOT...) BURST TYPE
ALL_DATA

Selection of burst type used to configure the selected slot.
ALL DATA Burst type for testing with freely programmable data contents
 IEC/IEEE-bus command SOUR:PDC:SLOT2:TYPE ADAT

SLOT LEVEL
 (UPLINK only)

Selection of level for selected slot.
OFF Maximum attenuation
 IEC/IEEE : SOUR:PDC:SLOT2:LEV OFF
FULL The level corresponds to the value indicated on the SMIQ LEVEL display.
 IEC/IEEE : SOUR:PDC:SLOT2:LEV FULL
ATTEN The level is reduced by the value set under SLOT ATTENUATION.
 IEC/IEEE : SOUR:PDC:SLOT2:LEV ATT

BURST STATE
 (DOWNLINK only)

Substitute for parameter SLOT LEVEL for downlink.
ON The burst contents defined in the data fields are sent in the selected slot.
 IEC/IEEE-bus : SOUR:PDC:SLOT2:LEV FULL
OFF Only 1s will be sent.
 IEC/IEEE-bus : SOUR:PDC:SLOT2:LEV OFF

Parameter SLOT LEVEL is omitted since the NADC base station in downlink always sends with the same power in each slot.

(SELECT SLOT...) ALL_DATA	R (UPLINK only)	Display of data contents in the 6 bit data field "Ramp" in hexadecimal form..
	G (UPLINK only)	Display of data contents in the 6 bit data field "Guard" in hexadecimal form.
	DATA	<p>Selection of data source for DATA fields. These fields are regarded as a continuous field, ie a pseudo-random sequence is fully continued from one DATA field to the next. The following data sources are available:</p> <p>PN.. PRBS data according to CCITT with periods between 2^9-1 and $2^{23}-1$. IEC/IEEE : SOUR:PDC:SLOT3:DATA PN15</p> <p>DLIST Data from a programmable data list. IEC/IEEE : SOUR:PDC:SLOT3:DATA DLIS</p> <p>SERDATA Data from data input SER DATA. IEC/IEEE : SOUR:PDC:SLOT3:DATA SDAT</p>

Selection: BURST TYPE = SYNC

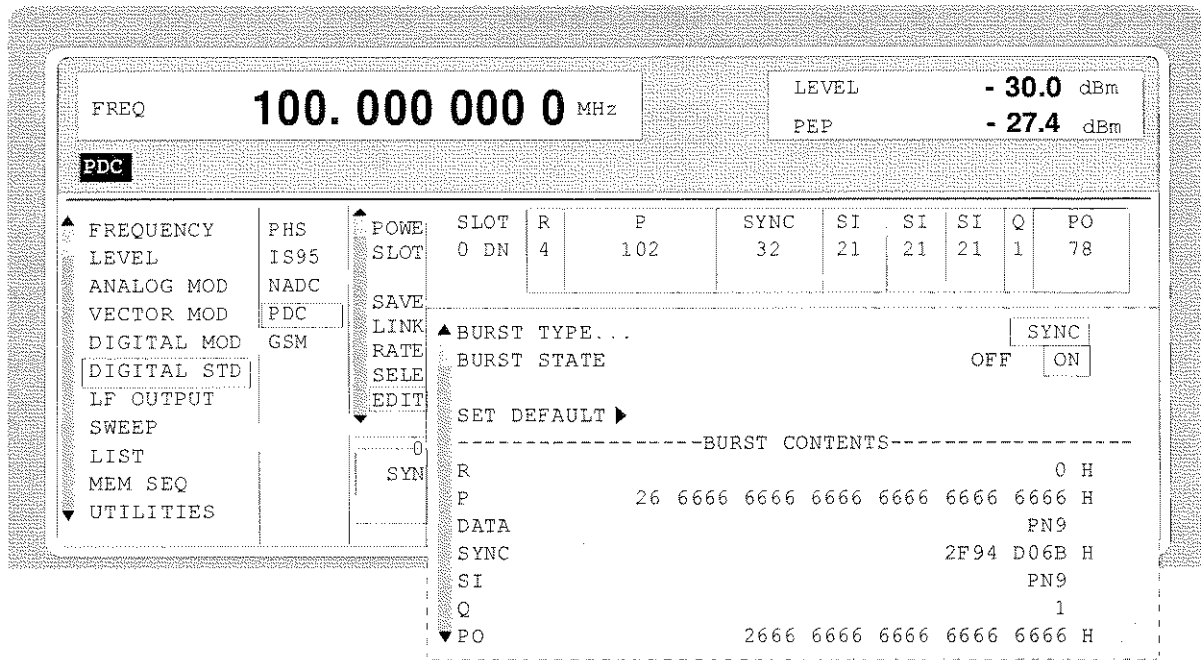

Fig. 2-98 Menu DIGITAL STD - PDC - SELECT SLOT, LINK DIRECTION = DOWNLINK, SMIQ equipped with Modulation Coder SMIQB10 and Data Generator SMIQB11

- (SELECT SLOT...) BURST TYPE SYNC** Selection of burst type used to configure the selected slot.
 SHORT Shortened Burst
 IEC/IEEE-bus command SOUR:PDC:SLOT2:TYPE SYNC
- SLOT LEVEL (UPLINK only)** Selection of level for selected slot.
 OFF Maximum attenuation
 IEC/IEEE : SOUR:PDC:SLOT2:LEV OFF
 FULL The level corresponds to the value indicated on the SMIQ LEVEL display.
 IEC/IEEE : SOUR:PDC:SLOT2:LEV FULL
 ATTEN The level is reduced by the value set under SLOT ATTENUATION.
 IEC/IEEE : SOUR:PDC:SLOT2:LEV ATT
- BURST STATE (DOWNLINK only)** Substitute for parameter SLOT LEVEL for downlink.
 ON The burst contents defined in the data fields are sent in the selected slot.
 IEC/IEEE-bus : SOUR:PDC:SLOT2:LEV FULL
 OFF Only 1s will be sent.
 IEC/IEEE-bus : SOUR:PDC:SLOT2:LEV OFF
 Parameter SLOT LEVEL is omitted since the NADC base station in downlink always sends with the same power in each slot.
- SET DEFAULT ►** Resets the subsequent parameters to the factory-set values.
 IEC/IEEE-bus command SOUR:PDC:SLOT8 PRES

(SELECT SLOT...) **G** Display of data contents in the 54 bit data field "Guard" in hexadecimal form.
SYNC (UPLINK only) The field is only displayed with link direction UPLINK selected.

R Display of data contents in the 6 bit data field "Ramp".

P Input value of the data field "Preamble" in hexadecimal form. The length of the field is 48 bit with link direction = UPLINK, and 102 bit with DOWNLINK
 IEC/IEEE-bus command SOUR:PDC:SLOT2:PRE #HFF

SYNC Input value for the 32 bit sync word in hexadecimal form. Depending on the selected slot and the link direction, the following sync words are predefined according to the PDC standard:

Slot No.	Downlink Sync Word	Uplink Sync Word
0	2F94D06B	D06B2F94
1	1D4EE2B1	E2B11D4E
2	70168FE9	8FE97016
3	83527CAD	7CAD8352
4	3678C987	C9873678
5	48D8B727	B72748D8

According to the standard, the sync words of the uplink are the inverted sync words of the downlink.

IEC/IEEE-bus SOUR:PDC:SLOT2:SYNC #HE2B11D4F

SI Selection of data source for "Sync Information" field. The data in each of the three SI fields are identical

PN.. PRBS data according to CCITT with periods between 2^9-1 and $2^{23}-1$.

IEC/IEEE SOUR:PDC:SLOT2:SOUR:SI PN15

DLIST Data from a programmable data list.

IEC/IEEE SOUR:PDC:SLOT2:SOUR:SI DLIS

SERDATA Data from data input SER DATA.

IEC/IEEE SOUR:PDC:SLOT2:SOUR:SI SDAT

Q Display of the tail bits.

PO Input value for the 78 bit "Postamble" field in hexadecimal form.
 (DOWNLINK only)

IEC/IEEE-bus command SOUR:PDC:SLOT2:POST #HFF

G2 Display of data contents in the 78 bit "Guard" field in hexadecimal form at the end of the slot.
 (UPLINK only)

Selection: BURST TYPE = VOX (only available with LINK DIRECTION = UPLINK)

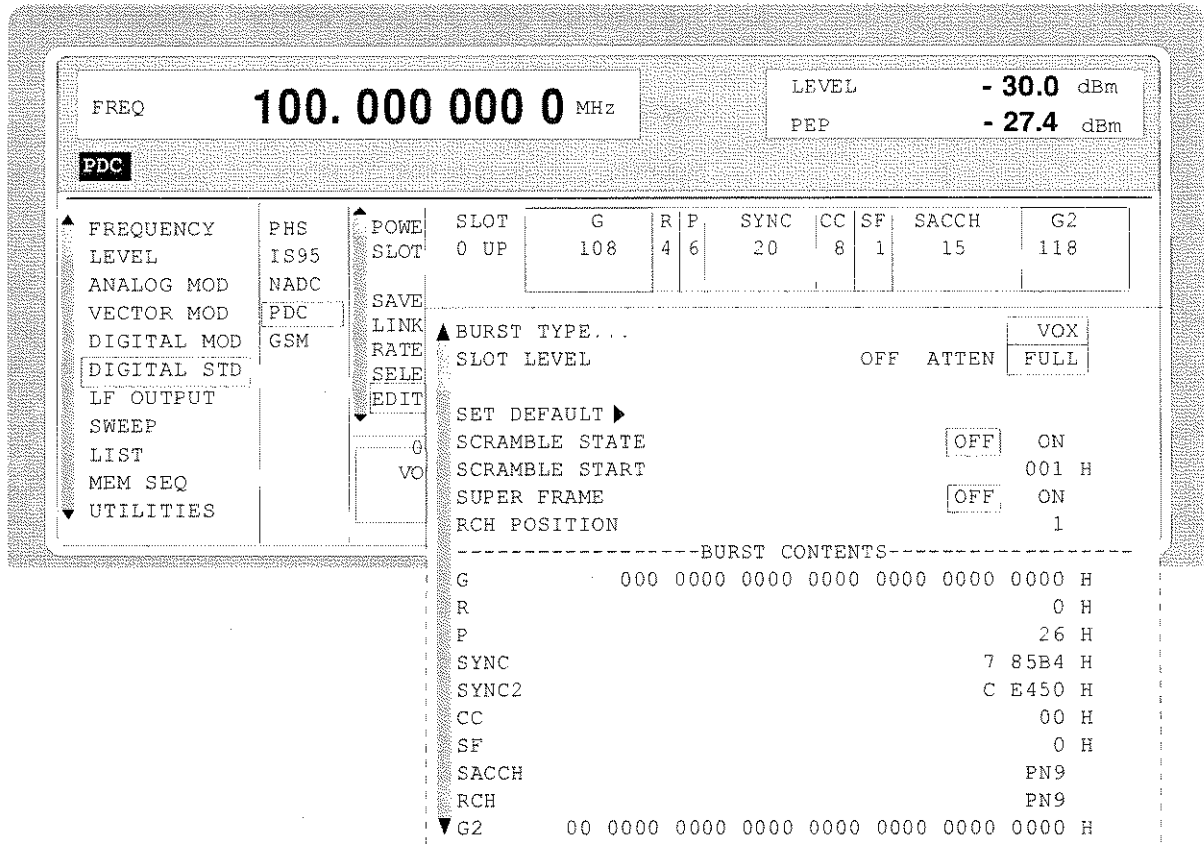

Fig. 2-99 Menu DIGITAL STD - PDC - SELECT SLOT, SMIQ equipped with Modulation Coder SMIQB10 and Data Generator SMIQB11

(SELECT SLOTT) BURST TYPE Selection of burst type used to configure the selected slot. VOX is only available with LINK DIRECTION = UPLINK selected.

VOX VOX burst
IEC/IEEE-bus command SOUR:PDC:SLOT2:TYPE VOX

SLOT LEVEL Selection of level for selected slot.

OFF Maximum attenuation
IEC/IEEE : SOUR:PDC:SLOT2:LEV OFF

FULL The level corresponds to the value indicated on the SMIQ LEVEL display.
IEC/IEEE : SOUR:PDC:SLOT2:LEV FULL

ATTEN The level is reduced by the value set under SLOT ATTENUATION.
IEC/IEEE : SOUR:PDC:SLOT2:LEV ATT

SET DEFAULT Resets the subsequent parameters to the factory-set values.
IEC/IEEE-bus command SOUR:PDC:SLOT8 PRES

**(SELECT SLOT...)
VOX
(UPLINK ONLY)**

Switch on/off of scrambling function. Scrambling with the continuous scramble sequence from a PN9 generator is applied to the data fields SF and SACCH.

IEC/IEEE-bus SOUR:PDC:SLOT2:SCR:STAT ON

**SCRAMBLE
START**

9 bit input value for initializing the scramble PN9 generator in hexadecimal form. The value 0 is not permissible, 1 is preset. The input field is only displayed if SCRAMBLE is switched on.

IEC/IEEE-bus SOUR:PDC:SLOT2:SCR:STAR #H2

SUPERFRAME

Switch on/off of the superframe generation. 18 frames form a superframe. If SUPERFRAME is switched on, RCH data instead of SACCH data will be sent in 2 slots. The first of the two RCH blocks is fixed in the first slot of the superframe, the position of the second can be set.

IEC/IEEE-bus SOUR:PDC:SLOT2:SFR:STAT ON

RCH POSITION

Input value for the position of the second RCH block. The input field is only displayed if SUPERFRAME is switched on.

IEC/IEEE-bus SOUR:PDC:SLOT2:SFR:RCHP 10

G

Display of data contents in the 108 bit "Guard" field at the beginning of the slot in hexadecimal form.

R

Display of data contents in the 4 bit data field "RAMP" in hexadecimal form.

P

Input value of the 26 bit data field "Preamble".

IEC/IEEE-bus command SOUR:PDC:SLOT2:PRE #HFF

SYNC

Input value for the 20 bit sync word in hexadecimal form. Depending on the selected slot, the following sync words are predefined according to the PDC standard:

Slot No.	VOX Sync Word
0	785B4
1	62DC9
2	7E28A
3	56B15
4	AE9B3
5	B2621

IEC/IEEE-bus SOUR:PDC:SLOT2:SYNC #H72DC9

(SELECT SLOT...) SYNC2
 VOX
 (UPLINK ONLY)

Input value for the 20 bit sync word in the first slot of a superframe in hexadecimal form. This sync word marks the beginning of a superframe. The input field is only displayed if SUPERFRAME is switched on. Depending on the selected slot, the following sync words are predefined according to the PDC standard:

Slot No.	VOX Sync2 Word
0	CE450
1	E1A90
2	18ED3
3	043E0
4	7D861

IEC/IEEE-bus command SOUR:PDC:SLOT2:SYNC E1A91

CC

Input value of the 8 bit data field " Color code ".

IEC/IEEE-bus command SOUR:PDC:SLOT2:CCOD #HFF

SF

Input value of the data field " Steal Flag ".

IEC/IEEE-bus command SOUR:PDC:SLOT2:SF #H0

SACCH

Selection of data source for SACCH field (Slow Associated Control Channel).

PN.. PRBS data according to CCITT with periods between 2^9-1 and $2^{23}-1$.

IEC/IEEE :SOUR:PDC:SLOT3:SACC PN15

DLIST Data from a programmable data list.

IEC/IEEE :SOUR:PDC:SLOT3:SACC DLIS

SERDATA Data from data input SER DATA.

IEC/IEEE :SOUR:PDC:SLOT3:SACC SDAT

RCH

Selection of data source for the RCH data field. RCH data replace SACCH data in certain slots of a superframe. The input field is only displayed if SUPERFRAME is switched on.

PN.. PRBS data according to CCITT with periods between 2^9-1 and $2^{23}-1$.

IEC/IEEE SOUR:PDC:SLOT3:SOUR:RCH PN9

DLIST Data from a programmable data list.

IEC/IEEE SOUR:PDC:SLOT3:SOUR:RCH DLIS

SERDATA Data from data input SER DATA.

IEC/IEEE SOUR:PDC:SLOT3:SOUR:RCH SDAT

G2

Display of data contents in the 118 bit "Guard" field at the end of the slot in hexadecimal form. The field is only displayed with LINK DIRECTION = UPLINK selected.

2.15 Digital Standard GSM

With the options Modulation Coder (SMIQB10) and Data Generator (SMIQB11) provided, modulation signals according to the GSM standard can be generated. GSM is a TDMA standard for cellular mobile radio networks used worldwide. SMIQ is suitable for use as a signal generator for all GSM types.

SMIQ can generate both the transmit signal of a base station (BS) and the transmit signal of a mobile station (MS). Transmission from BS to MS is called "downlink", "uplink" being used for transmission in the opposite direction.

Each TDMA frame consists of 8 slots. Each slot can be switched on or off separately. Moreover, a defined intermediate level can be set.

A burst type has to be defined to configure a slot. The following burst types can be selected:

- NORM the so-called "normal burst",
- DUMMY burst type with a defined data pattern according to GSM standard and
- ALL_DATA burst type for test purposes with freely programmable data contents.

The following internal modulation sources are available:

- different PRBS generators with a sequence length between 2^9-1 and $2^{23}-1$ and
- data lists, ie freely programmable data sequences from the data generator memory.

For generating the GSM signals, SMIQ inserts the modulation data continuously (in real time) into the selected slots. Using a digital signal processor the data generator generates a data sequence with modulation data and control signals for envelope control.

The data generator in SMIQ generates a data stream which is converted into IQ signals in the modulation coder. According to the GSM standard, the modulation type is GMSK at a symbol rate of 270.833 ksymbol/s and Gauss filtering. The symbol rate can be changed in SMIQ. GFSK with adjustable frequency deviation can be used as a modulation type, too.

2.15.1 Sync and Trigger Signals

The data generator generates a data sequence with modulation data, control signals for envelope control, and synchronization signals.

When TRIGGER MODE AUTO is selected, the GSM signal generation is started automatically.

This start can also be activated by an external trigger signal (TRIGGER MODE ARMED_AUTO) which allows a synchronous sequence for BER measurements to be carried out on receivers.

A trigger signal can be fed via the TRIGIN input at connector PAR DATA. The active slope of a trigger signal applied there executes a trigger event.

GSM signal generation at a frame limit is started after a trigger event. Data from data lists are inserted into the selected slots starting from the first bit. PRBS generators start with the set initialization status.

Signal generation either starts immediately after the active slope of the trigger signal or after a settable number of symbols (EXT TRIGGER DELAY). Retriggering (EXT RETRIG) can be inhibited for a settable number of symbols (EXT RETRIGGER INHIBIT).

A trigger event can be executed manually using EXECUTE TRIGGER or via the IEC/IEEE bus.

When a trigger event is executed, a trigger signal is output at the TRIGOUT 3 output of SMIQ.

SMIQ also generates the following sync signals:

- a frame clock at TRIGOUT 1 output,
- a frame or multiframe clock at TRIGOUT 2 output with settable position in the frame,
- the symbol clock and the bit clock.

A clock synthesizer on the modulation coder generates the symbol clock and the bit clock in SMIQ. The two clocks are identical for GSM. All the clock signals are synchronized to the 10-MHz reference of SMIQ. The bit clock is available at connector BIT CLOCK. If required, the clock synthesizer in SMIQ can be synchronized to an external bit clock.

The clock signal is selected in the menu via CLOCK-CLOCK SOURCE EXT.

To allow for a trouble-free synchronization of the clock synthesizer first apply the external clock and set the correct symbol rate at SMIQ. Then switch CLOCK SOURCE from INT to EXT.

Note: *The set symbol rate should not differ by more than 1% from the symbol rate of the external signal.*

2.15.2 PN Generators as Internal Data Source

Independent PN generators (Pseudo Noise) can be selected for each slot as data source for data field DATA. These PN generators provide pseudo-random bit sequences of different length or period. That is why they are also called PRBS generators (Pseudo Random Binary Sequence).

Data sequences are sequences of maximum length which are generated by means of feedback shift registers.

The following figure gives an example of a 9 bit generator with feedbacks after register 4 and 0 (output).

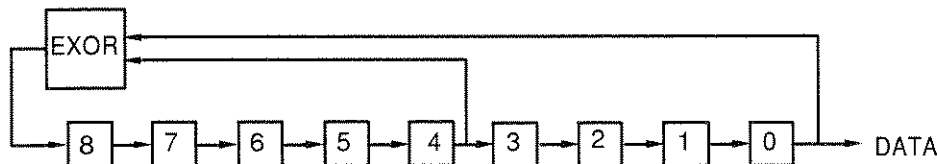

The pseudo-random sequence of a PRBS generator is clearly defined by the number of registers and the feedback. The following table describes all PRBS generators available:

Table 2-19 PRBS generators for GSM

PRBS generator	Length in bits	Feedback after
9 bit	$2^9 - 1 = 511$	Register 4, 0
11 bit	$2^{11} - 1 = 2047$	Register 2, 0
15 bit	$2^{15} - 1 = 32767$	Register 1, 0
16 bit	$2^{16} - 1 = 65535$	Register 5, 3, 2, 0
20 bit	$2^{20} - 1 = 1048575$	Register 3, 0
21 bit	$2^{21} - 1 = 2097151$	Register 2, 0
23 bit	$2^{23} - 1 = 8388607$	Register 5, 0

PN generators PN9,11,15, 20 and PN23 are configured according to CCITT Rec. 0.151/152/153. The output sequence is inverted for generators PN15 and PN23.

The start value of the PN generators is different in the slots and equals

$$\text{start value} = 1 + 14 \text{ hex} \times \text{slot number}$$

Example: PN9 generator in slot 1 with start value 15hex = 10101 binary.

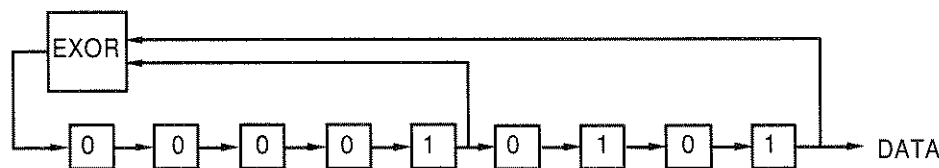

The resulting output sequence is 1010100000010100101011110010 etc.

2.15.3 Lists as Internal Data Source

A freely programmable memory on the data generator serves as internal data source for the data fields of the slots. The data are managed in so-called lists. A list editor allows to select, copy, modify and delete data lists (DATA LIST).

The list editor is available via menu DIGITAL-MOD - SOURCE....

2.15.4 External Modulation Data

External data can (only) be applied via the SERDATA interface. A selection of SERDATA as data source is only possible for a single data field of a slot. For further information on the characteristics of the SERDATA interface see Annex A.

To ensure that the external data bits are assigned to specific positions in the data field of the selected slot and that they are reproducible, the buffer of the RS-232 transmitter and receiver has to be deleted. A triggered start has to follow.

The following setting sequence is required in the DIGITAL STD - GSM menu:

1. Carry out desired settings in menu.
2. Select data source SERDATA for the data field of the slot using SELECT SLOT -
3. Make connection to external data source, but do not yet start external data source.
4. Switch off digital standard using STATE - OFF.
5. Set TRIGGER MODE ARMED_AUTO.
In this state, SMIQ is ready for reception, but discards data that are read in via SERDATA.
6. Switch on digital standard with STATE ON.
7. Start external data source.
The read-in data are written into the receiving buffer. Only if this buffer is filled can SMIQ react to a trigger event.
8. Activate trigger event. Signal generation is thus started at a frame limit. The first bit received via SERDATA is put to the first bit position in the selected data field.

2.15.5 Menu DIGITAL STANDARD - GSM

Menu DIGITAL STD - GSM provides access to settings for generating GSM signals.

Menu selection: DIGITAL STD - GSM

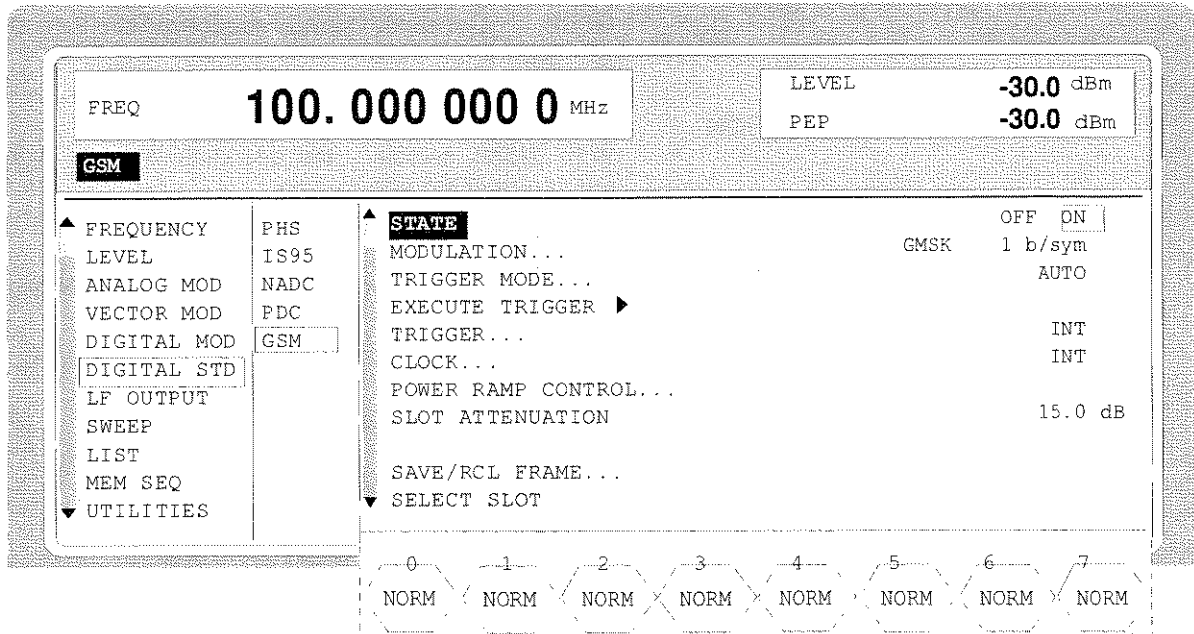

Fig. 2-100 Menu DIGITAL STD - GSM, SMIQ equipped with Modulation Coder SMIQB10 and Data Generator SMIQB11

STATE Switch on/off of Digital Standard GSM modulation. Vector Modulation or Digital Modulation will be switched off automatically.
IEC/IEEE-bus command SOUR:GSM:STAT ON

MODULATION... Opens a window for setting the modulation parameters.

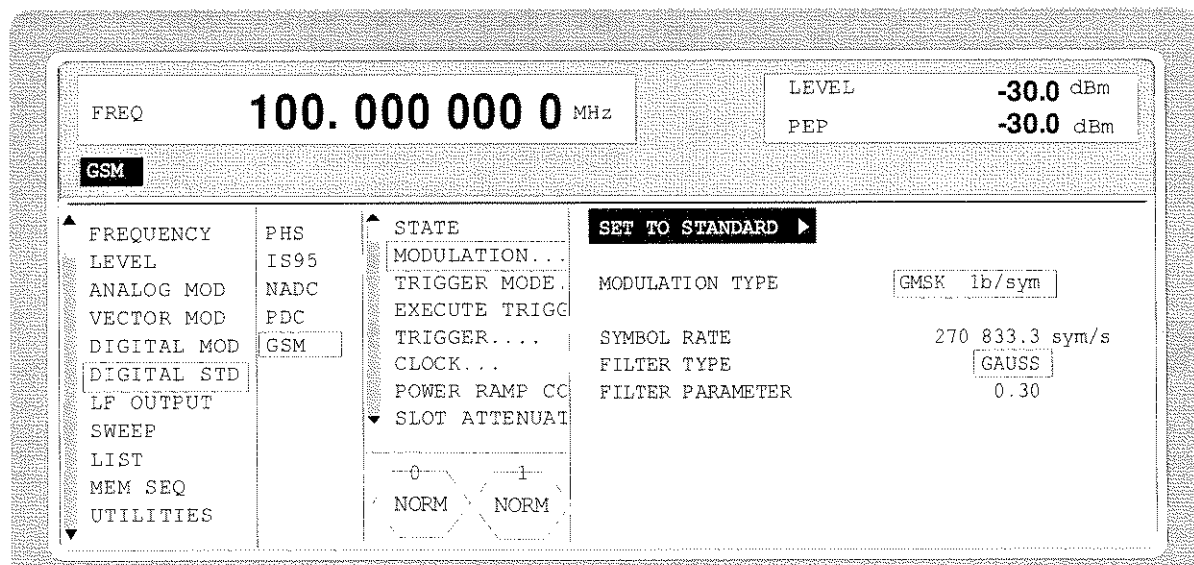

Fig. 2-101 Menu DIGITAL STD - GSM - MODULATION..., SMIQ equipped with Modulation Coder SMIQB10 and Data Generator SMIQB11

(MODULATION...)	<p>SET TO STANDARD ► Sets the subsequent modulation parameters to the values predefined by the standard.</p> <p>MODULATION TYPE Opens a window for selection of the modulation type. GMSK Gaussian Minimum Shift Keying GFSK Gaussian filtered Frequency Shift Keying IEC/IEEE-bus SOUR:GSM:FORMat GMSK</p> <p>FSK DEVIATION Input value of deviation with GFSK selected. With GMSK selected, the deviation is fixed to the fourth part of the symbol rate. IEC/IEEE-bus SOUR:GSM:FSK:DEV 67 KHZ</p> <p>SYMBOL RATE Input value for the symbol clock. 270.833 ksymbol/s are preset. IEC/IEEE-bus SOUR:GSM:SRAT 270KHZ</p> <p>FILTER Display of the baseband filter.</p> <p>FILTER PARAMETER Input value for the BxT value (Gaussian filter). IEC/IEEE-bus SOUR:GSM:FILT:PAR 0.31</p>
TRIGGER MODE...	<p>Opens a window for selecting the trigger mode.</p> <p>AUTO The GSM signals are continuously transmitted in the activated slots. IEC/IEEE-bus command SOUR:GSM:SEQ AUTO</p> <p>RETRIG The GSM signals are continuously transmitted in the activated slots. A trigger event causes a restart. IEC/IEEE-bus command SOUR:GSM:SEQ RETR</p> <p>ARMED_AUTO The GSM signal generation does not start until a trigger event has occurred. The unit then automatically switches over to the AUTO mode and can no longer be triggered. IEC/IEEE-bus command SOUR:GSM:SEQ AAUT</p> <p>ARMED_RETRIG The GSM signal generation does not start until a trigger event has occurred. The unit then automatically switches over to the RETRIG mode. Each new trigger event causes a restart. IEC/IEEE-bus command SOUR:GSM:SEQ ARET</p>
EXECUTE TRIGGER ►	<p>Executes a trigger even to start the GSM signal generation. IEC/IEEE-bus command :TRIG:DM IMM</p>

TRIGGER... Opens a window for selecting the trigger source, for configuring the trigger output signals and for setting the time delay of an external trigger signal.

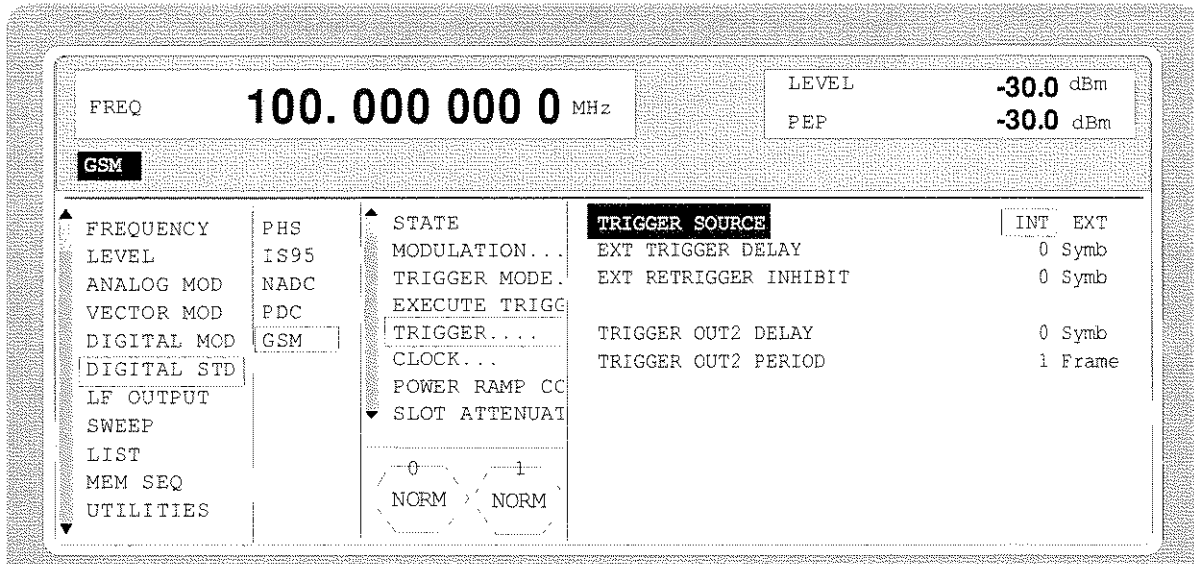

Fig. 2-102 Menu DIGITAL STD - GSM_TRIGGER..., SMIQ equipped with Modulation Coder SMIQB10 and Data Generator SMIQB11

(TRIGGER...)	TRIGGER SOURCE	<p>Selection of trigger source.</p> <p>EXT The GSM signal generation is started by the active slope of an external trigger signal. The polarity, the trigger threshold and the input resistance of the TRIGIN input can be modified in menu DIGITAL MOD - EXT INPUTS.</p> <p>INT A trigger event can be executed by EXECUTE TRIGGER ►.</p> <p>IEC/IEEE-bus SOUR:GSM:TRIG:SOUR EXT</p>
	EXT TRIGGER DELAY	<p>Setting the number of symbols by which an external trigger signal is delayed before it starts the GSM signal generation. This is used for setting the time synchronization between the the SMIQ and the DUT.</p> <p>IEC/IEEE-bus SOUR:GSM:TRIG:DEL 3</p>
	EXT RETRIGGER INHIBIT	<p>Setting the number of symbols for which a restart is inhibited after a trigger event. With TRIGGER MODE RETRIG selected, each new trigger signal restarts the GSM signal generation. This restart can be inhibited for the entered number of symbols.</p> <p>Example: The entry of 1000 symbols causes new trigger signals to be ignored for the duration of 1000 symbols after a trigger event</p> <p>IEC/IEEE-bus SOUR:GSM:TRIG:INH 1000</p>

(TRIGGER...)	TRIGGER OUT 2 DELAY	Input value of delay of trigger signal at TRIGOUT 2 output compared with beginning of frame. IEC/IEEE-bus SOUR:GSM:TRIG:OUTP:DEL 2
	TRIGGER OUT2 PERIOD	Input value of output signal period at TRIGOUT 2 output given in frames. IEC/IEEE-bus SOUR:GSM:TRIG:OUTP:PER 1

CLOCK... Opens a window for selecting the clock source and for setting a delay.

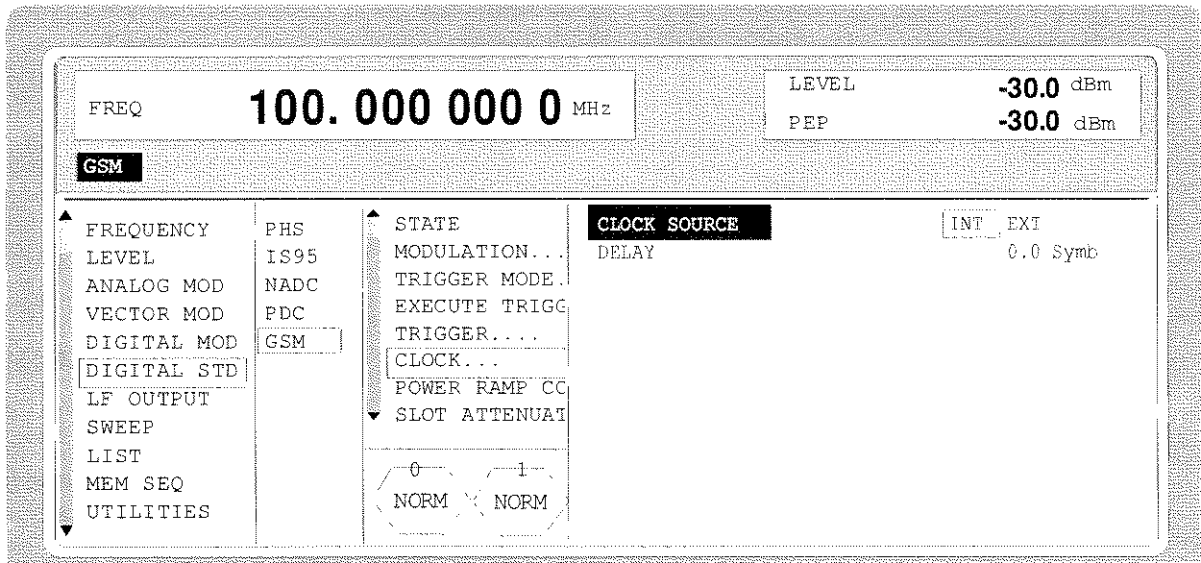

Fig. 2-103 Menu DIGITAL STD - GSM - CLOCK..., SMIQ equipped with Modulation Coder SMIQB10 and Data Generator SMIQB11

(CLOCK...)	CLOCK SOURCE	Selection of clock source. INT SMIQ uses internally generated clock signals. EXT An external bit clock is fed in at connector BIT CLOCK. The clock synthesizer on the modulation coder is synchronized to this clock. The symbol rate has to be set with an accuracy of $\pm 1\%$. The polarity, the trigger threshold and the input resistance of the clock inputs can be modified in menu DIGITAL MOD - EXT INPUTS. IEC/IEEE-bus SOUR:GSM:CLOC:SOUR INT
	DELAY	Setting the delay of generated modulation signal to an external clock. This can be used, for example, for synchronization with a second unit to achieve time synchronization between the modulation signals of the two units. IEC/IEEE-bus SOUR:GSM:CLOC:DEL 0.5

POWER RAMP CONTROL...

Opens a window for setting the envelope control, especially for the rising and falling ramp at the beginning and end of a slot.

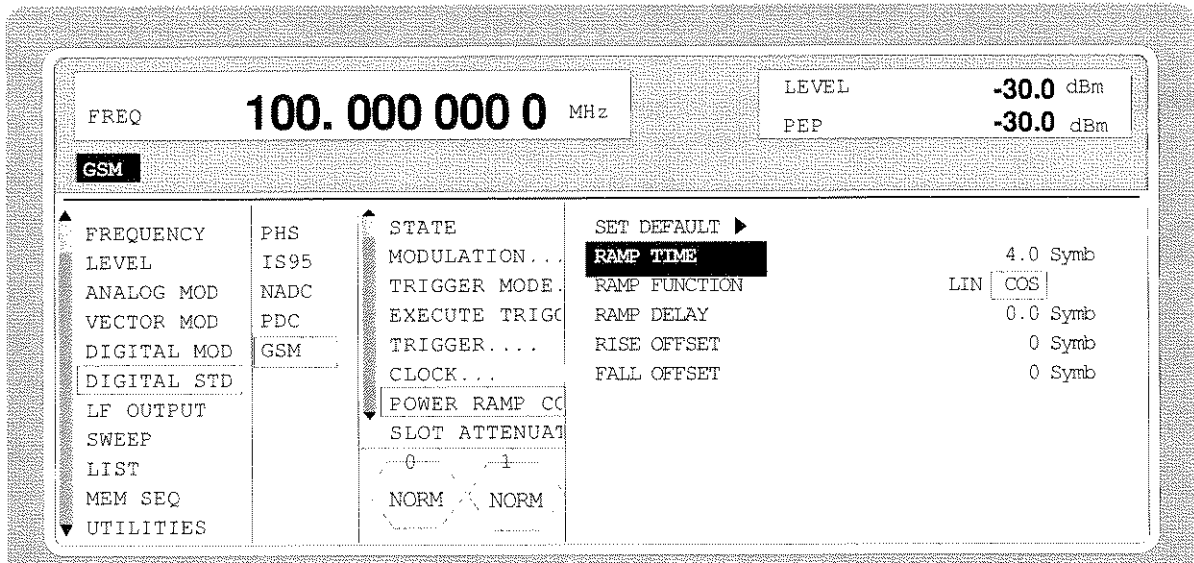

Fig. 2-104 Menu DIGITAL STD - GSM - POWER RAMP CONTROL... , SMIQ equipped with Modulation Coder SMIQB10 and Data Generator SMIQB11

(POWER RAMP CONTROL...)

SET DEFAULT ►

Resets the subsequent parameters to the factory-set values.

IEC/IEEE-bus : SOUR:GSM:PRAM:PRES

RAMP TIME

Input value for the rise and fall time of the envelope at the beginning or end of a slot. The time is set in units of symbol period.

IEC/IEEE-bus SOUR:GSM:PRAM:TIME 2.5

RAMP FUNCTION

Selection of shape of rising and falling ramp for envelope control.

LIN Linear ramp function.

COS Cosine function. A more favourable spectrum than that of the LIN function is obtained.

IEC/IEEE-bus SOUR:GSM:PRAM:SHAP LIN

RAMP DELAY

Input value for a shift of the envelope characteristic to the modulated signal. A positive value causes a delay of the envelope. The values are set in the units of the symbol length.

IEC/IEEE-bus SOUR:GSM:PRAM:DEL 0.1

RISE OFFSET

Input value for a positive or negative offset of the rising ramp of the envelope at the beginning of a slot.

IEC/IEEE-bus SOUR:GSM:PRAM:ROFF -1

FALL OFFSET

Input value for a positive or negative offset of the falling ramp of the envelope at the end of a slot.

IEC/IEEE-bus SOUR:GSM:PRAM:FOFF 1

SLOT ATTENUATION Input value in dB for the level reduction of all active slots whose SLOT LEVEL was set to ATTEN. Menu SELECT SLOT allows the slots to be determined whose level is to be reduced.

IEC/IEEE-bus command `SOUR:GSM:SLOT:ATT 40 DB`

SAVE/RCL FRAME... Opens a window for saving and loading a frame configuration. Loading a frame affects all parameters that can be set under SELECT SLOT.

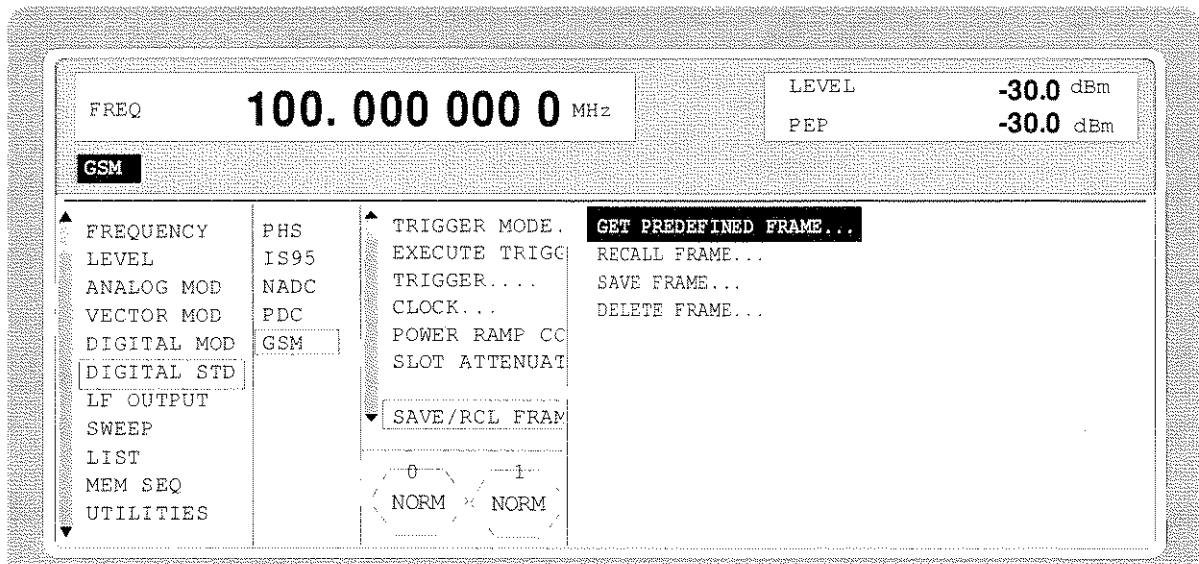

Fig. 2-105 Menu DIGITAL STD - GSM - SAVE/RCL FRAME, SMIQ equipped with Modulation Coder SMIQB10 and Data Generator SMIQB11

- (SAVE/RCL FRAME...) GET PREDEFINED FRAME...** Loads a factory-set frame configuration.
 NBO Normal Burst in slot 0
 IEEE `SOUR:GSM:FLIS:PRED:LOAD "nb0"`
- RECALL FRAME...** Loads a frame configuration saved by the user.
 IEC/IEEE-bus `SOUR:GSM:FLIS:LOAD "name"`
- SAVE FRAME...** Saves a user-defined frame configuration.
 IEC/IEEE-bus `SOUR:GSM:FLIS:STOR "name"`
- DELETE FRAME...** Deletes a frame configuration saved by the user.
 IEC/IEEE-bus `SOUR:GSM:FLIS:DEL "name"`

SELECT SLOT...

Selection of one of 8 possible slots. When selecting the slot, a window is opened in which the data contents belonging to this slot can be defined.

Note: If the cursor is placed onto a slot in the diagram, it may be switched on and off by pressing one of the unit keys (toggle function).

Selection: BURST TYPE = NORM

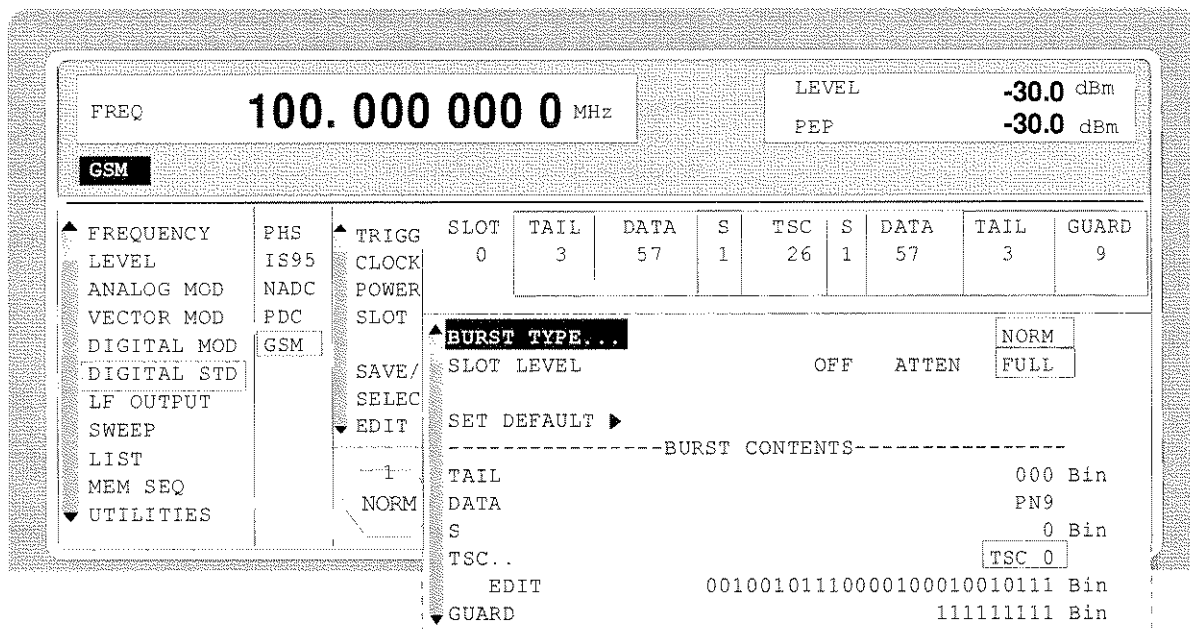

Fig. 2-106 Menu DIGITAL STD - GSM - SELECT SLOT, SMIQ equipped with Modulation Coder SMIQB10 and Data Generator SMIQB11

- (SELECT SLOT...) BURST TYPE**
NORM

Opens a window for the selection of the burst type used to configure the selected slot.

NORM Normal Burst

IEC/IEEE-bus command SOUR:GSM:SLOT2:TYPE NORM
- SLOT LEVEL**

Selection of level for selected slot.

OFF Maximum attenuation

IEC/IEEE : SOUR:GSM:SLOT2:LEV OFF

FULL The level corresponds to the value indicated on the SMIQ LEVEL display.

IEC/IEEE : SOUR:GSM:SLOT2:LEV FULL

ATTEN The level is reduced by the value set under SLOT ATTENUATION.

IEC/IEEE : SOUR:GSM:SLOT2:LEV ATT
- SET DEFAULT ►** Resets the subsequent parameters to the factory-set values.

IEC/IEEE-bus command SOUR:GSM:SLOT8:PRES

(SELECT SLOT...) NORM	HOP TRIGGER	Switches the HOP trigger signal on or off. With ON selected, a HOP signal will be generated at the end of the selected slot. The signal is available at the HOP output of the PARDATA connector. It can be used to perform a frequency hop mode in the LIST MODE (see section "List Mode"). IEEE-bus command <code>SOUR:GSM:SLOT1:HOP ON</code>
	TAIL	Display of data contents in the 3 bit data field "Tail". The tail bits are set to 000 according to the GSM standard.
	DATA	Selection of data source for DATA fields. These fields are regarded as a continuous field, ie a pseudo-random sequence is fully continued from one DATA field to the next. The following data sources are available: PN.. PRBS data according to CCITT with periods between 2^9-1 and $2^{23}-1$. IEC/IEEE <code>:SOUR:GSM:SLOT3:DATA PN15</code> DLIST Data from a programmable data list. IEC/IEEE <code>:SOUR:GSM:SLOT3:DATA DLIS</code> SERDATA Data from data input SER DATA. IEC/IEEE <code>:SOUR:GSM:SLOT3:DATA SDAT</code>
	S	Setting for the so-called "Stealing Flag". The selected setting is valid for the two S fields. IEEE-bus command <code>SOUR:GSM:SLOT2:SF 1</code>
	TSC...	Opens a window for selecting the so-called "Training Sequence Code". A selection between 8 different training sequences is possible. IEEE-bus command <code>SOUR:GSM:SLOT2:TSC 0</code>
	EDIT	Input field for binary modifications of the training sequence. A modified training sequence is stored as a USER sequence after a SAVE FRAME has been called up. IEEE-bus command <code>SOUR:GSM:SLOT2:USER #B011011...</code>
	GUARD	Display of data content in the Guard field in binary form. The length of the field is 8 bit in slots 1,2,3,5,6,7 and 9 bit in slots 0 and 4. It is thus ensured that a frame has exactly 1250 bit as stipulated in the GSM standard.

Selection: BURST TYPE = DUMMY

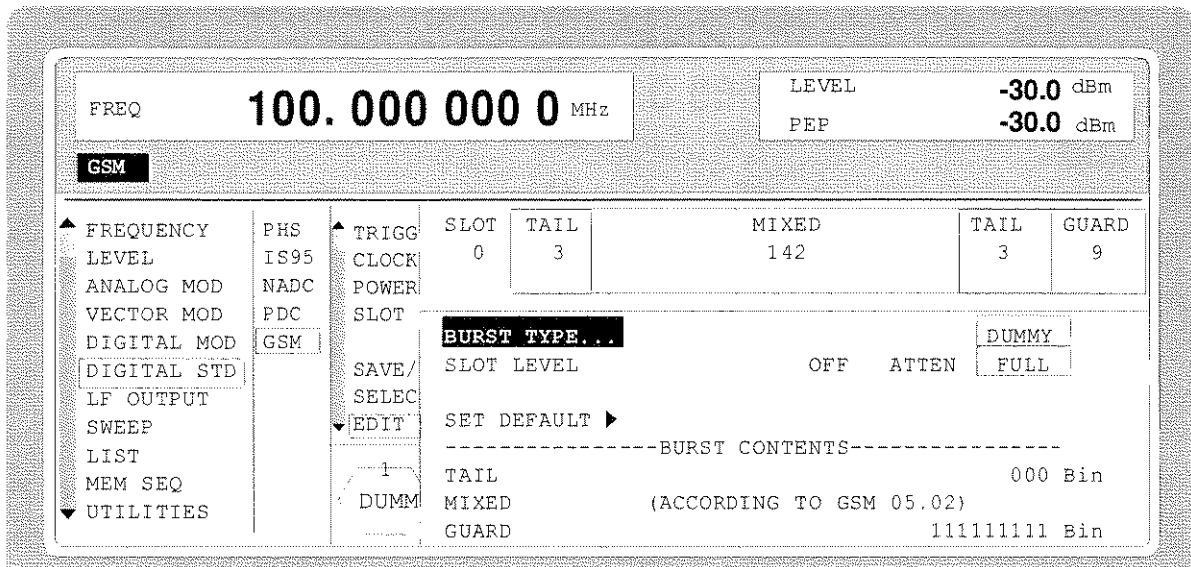

Fig. 2-107 Menu DIGITAL STD - GSM - SELECT SLOT, SMIQ equipped with Modulation Coder SMIQB10 and Data Generator SMIQB11

<p>(SELECT SLOT...)</p> <p>DUMMY</p>	<p>BURST TYPE</p>	<p>Opens a window for the selection of the burst type used to configure the selected slot.</p> <p>DUMMY Synchronization Burst</p> <p>IEC/IEEE-bus command SOUR:GSM:SLOT2:TYPE DUMM</p>
<p>SLOT LEVEL</p>	<p>SLOT LEVEL</p>	<p>Selection of level for selected slot.</p> <p>OFF Maximum attenuation</p> <p>IEC/IEEE : SOUR:GSM:SLOT2:LEV OFF</p> <p>FULL The level corresponds to the value indicated on the SMIQ LEVEL display.</p> <p>IEC/IEEE : SOUR:GSM:SLOT2:LEV FULL</p> <p>ATTEN The level is reduced by the value set under SLOT ATTENUATION.</p> <p>IEC/IEEE : SOUR:GSM:SLOT2:LEV ATT</p>
<p>TAIL</p>	<p>TAIL</p>	<p>Display of data content in the 3 bit data field "Tail ". The tail bits are set to 000 according to the GSM standard.</p>
<p>MIXED</p>	<p>MIXED</p>	<p>Display of data content of the mixed-bit field. It has a data content stipulated by GSM 05.02, the so-called mixed bits":</p> <pre>1111101101101100000101001001110000010010001000000 01111100011100010111000101110001010111010010100011 00110011100111101001111100010010111101010</pre>
<p>GUARD</p>	<p>GUARD</p>	<p>Display of data content in the Guard field in binary form. The length of the field is 8 bit in slots 1,2,3,5,6,7 and 9 bit in slots 0 and 4. It is thus ensured that a frame has exactly 1250 bit as stipulated in the GSM standard.</p>

Selection BURST TYPE = ALL_DATA

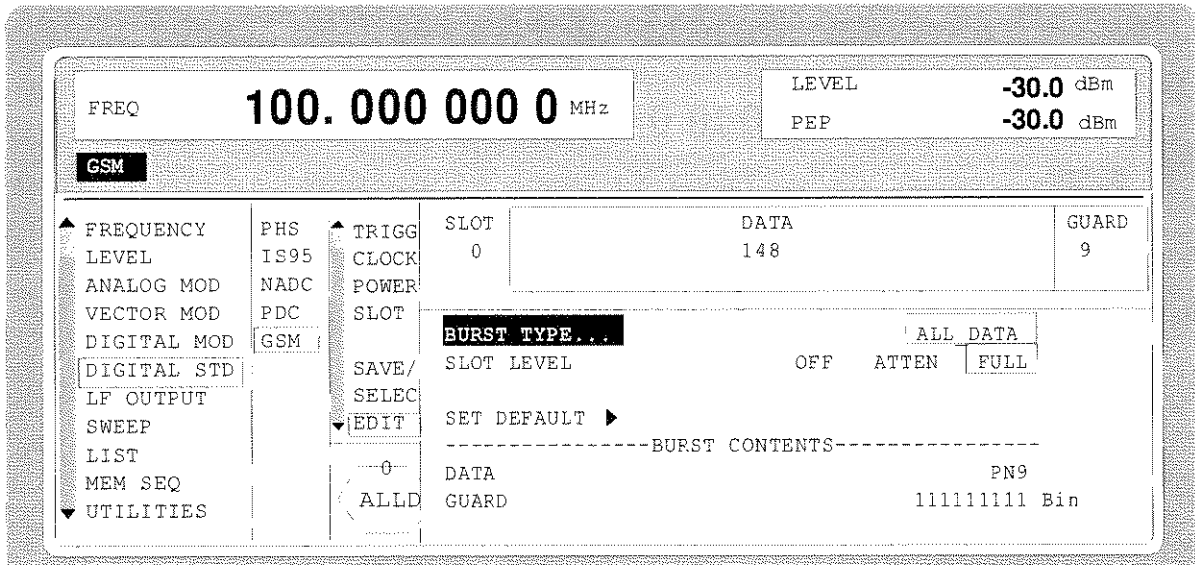

Fig. 2-108 Menu DIGITAL STD - GSM - SELECT SLOT, SMIQ equipped with Modulation Coder SMIQB10 and Data Generator SMIQB11

- (SELECT SLOT...) BURST TYPE** Opens a window for the selection of burst type used to configure the selected slot.
ALL_DATA ALL_DATA Burst type for testing with freely programmable data contents.
 IEC/IEEE-bus command SOUR:GSM:SLOT2:TYPE ADAT
- SLOT LEVEL** Selection of level for selected slot.
 OFF Maximum attenuation
 IEC/IEEE : SOUR:GSM:SLOT2:LEV OFF
 FULL The level corresponds to the value indicated on the SMIQ LEVEL display.
 IEC/IEEE : SOUR:GSM:SLOT2:LEV FULL
 ATTEN The level is reduced by the value set under SLOT ATTENUATION.
 IEC/IEEE : SOUR:GSM:SLOT2:LEV ATT
- DATA** Selection of data source for DATA fields. These fields are regarded as a continuous field, ie a pseudo-random sequence is fully continued from one DATA field to the next. The following data sources are available:
 PN.. PRBS data according to CCITT with periods between 2^9-1 and $2^{23}-1$.
 IEC/IEEE : SOUR:GSM:SLOT3:DATA PN15
 DLIST Data from a programmable data list.
 IEC/IEEE : SOUR:GSM:SLOT3:DATA DLIS
 SERDATA Data from data input SER DATA.
 IEC/IEEE : SOUR:GSM:SLOT3:DATA SDAT
- GUARD** Display of data content in the Guard field in binary form. The length of the field is 8 bit in slots 1,2,3,5,6,7 and 9 bit in slots 0 and 4. It is thus ensured that a frame exactly has 1250 bit as stipulated in the GSM standard.

2.16 Digital Standard DECT

With the options Modulation Coder (SMIQB10) and Data Generator (SMIQB11) provided, modulation signals according to the ETSI DECT standard can be generated. DECT is a TDMA standard for private and public cordless phones.

SMIQ can generate both the transmit signal of a cell station (FP, Fixed Part) and the transmit signal of a personal station (PP, Portable Part). Transmission from FP to PP is called "downlink", "uplink" being used for transmission in the opposite direction.

Uplink and downlink are transmitted in the separate time slots of a frame using the time duplex method. Each frame consists of 24 slots. The data contents of each slot can be defined individually by SMIQ by means of a slot editor. Each slot can be switched on or off. A defined intermediate level can also be set. A maximum of 12 slots within a frame can be switched on simultaneously.

A slot type has to be defined to configure a slot. The following slot types can be selected:

- FULL full slot; simulation of a basic R32 physical channel,
- DOUBLE double slot, simulation of a high capacity R80 physical channel and
- ALL_DATA slot type for test purposes with arbitrarily programmable data contents in full slot format.

The following internal modulation sources are available:

- different PRBS generators with a sequence length between 2^9-1 and $2^{23}-1$ and
- data lists, i.e. freely programmable data sequences from the data generator memory.

For generating DECT signals, SMIQ inserts the modulation data continuously (in real time) into the selected slots. Using a digital signal processor the data generator generates a data sequence with modulation data and control signals for envelope control.

The data generator in SMIQ generates a data stream which is converted into IQ signals in the modulation coder. According to the DECT standard, the default modulation type is GFSK with a symbol rate of 1152 ksymbols/s and Gauss filtering. Symbol rate and filtering can be changed in SMIQ. Alternatively, $\pi/4$ DQPSK with $\sqrt{\cos}$ filtering may be selected.

2.16.1 Sync and Trigger Signals

The data generator generates a data sequence with modulation data, control signals for envelope control, and synchronization signals.

When TRIGGER MODE AUTO is selected, the DECT signal generation starts automatically.

Trigger signals for synchronized sequences can be used for measuring the bit error rate of receivers. A trigger signal can be fed via the TRIGIN input at connector PAR DATA. The active slope of a trigger signal applied there executes a trigger event.

DECT signal generation at a frame limit is started after a trigger event. Data from data lists are inserted into the selected slots starting from the first bit. PRBS generators start with the set initialization status.

Signal generation either starts immediately after the active slope of the trigger signal or after a settable number of symbols (EXT TRIGGER DELAY). Retriggering (RETRIG) can be inhibited for a settable number of symbols (EXT RETRIGGER INHIBIT).

A trigger event can be executed manually or via the IEC/IEEE bus using EXECUTE TRIGGER.

When a trigger event is executed, a trigger signal is output at the TRIGOUT 3 output of SMIQ.

SMIQ also generates the following sync signals:

- a frame clock at TRIGOUT 1 output,
- a frame or multiframe clock at TRIGOUT 2 output with settable position in the frame,
- the symbol clock and the bit clock.

A clock synthesizer on the modulation coder generates the symbol clock and the bit clock in SMIQ. All clock signals are synchronized to the 10-MHz reference of SMIQ. The bit clock is available at connector BIT CLOCK. If desired, the clock synthesizer in SMIQ can be synchronized to an external bit clock.

The clock source is selected in the CLOCK-CLOCK SOURCE EXT menu.

To allow for a trouble-free synchronization of the clock synthesizer first apply the external clock and set the correct symbol rate at SMIQ. Then switch CLOCK SOURCE from INT to EXT.

Note: *The set symbol rate should not differ by more than 1% from the symbol rate of the external signal.*

2.16.2 PN Generators as Internal Data Source

Independent PN generators (Pseudo Noise) can be selected for each slot as data sources for the data fields A-FIELD, B-FIELD and DATA. These PN generators provide pseudo-random bit sequences of different length or period. That is why they are also called PRBS generators (Pseudo Random Binary Sequence).

Data sequences are sequences of maximum length which are generated by means of feedback shift registers.

The following figure gives an example of a 9-bit generator with feedbacks after register 4 and 0 (output).

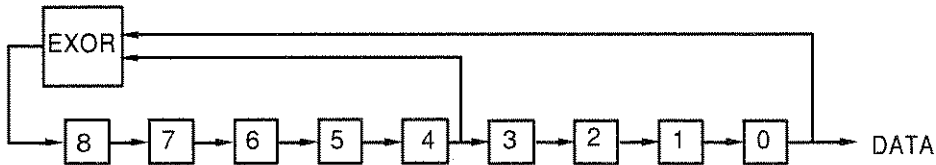

The pseudo-random sequence of a PRBS generator is clearly defined by the number of registers and the feedback. The following table describes all PRBS generators available:

Table 2-20 PRBS generators for DECT

PRBS generator	Length in bits	Feedback after
9 bit	$2^9 - 1 = 511$	Register 4, 0
11 bit	$2^{11} - 1 = 2047$	Register 2, 0
15 bit	$2^{15} - 1 = 32767$	Register 1, 0
16 bit	$2^{16} - 1 = 65535$	Register 5, 3, 2, 0
20 bit	$2^{20} - 1 = 1048575$	Register 3, 0
21 bit	$2^{21} - 1 = 2097151$	Register 2, 0
23 bit	$2^{23} - 1 = 8388607$	Register 5, 0

PN generators PN9,11,15,20 and PN23 are configured according to CCITT Rec. 0.151/152/153. The output sequence is inverted for generators PN15 and PN23.

The start value of the PN generators is different in the slots and equals

$$\text{start value} = 1 + 14 \text{hex} \times \text{slot number}$$

Example: PN9 generator in slot 1 with start value 15hex = 10101 binary.

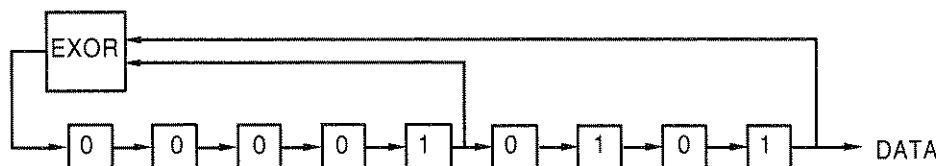

The resulting output sequence is 1010100000010100101011110010 etc.

2.16.3 Lists as Internal Data Source

A freely programmable memory on the data generator serves as an additional internal data source for the data fields of the slots. The data are managed in so-called lists. A list editor allows to select, copy, modify and delete data lists (DATA LIST).

The list editor is available via menu DIGITAL-MOD - SOURCE....

2.16.4 External Modulation Data

External data can (only) be applied via the SERDATA interface. A selection of SERDATA as data source is only possible for a single data field of a slot. For further information on the characteristics of the SERDATA interface see Annex A.

To ensure that the external data bits are assigned to specific positions in the data field of the selected slot and that they are reproducible, the buffer of the RS-232 transmitter and receiver has to be deleted. A triggered start has to follow.

The following setting sequence is required in the DIGITAL STD - DECT menu:

1. Carry out desired settings in menu.
2. Select data source SERDATA for the data field of the slot using SELECT SLOT -
3. Make connection to external data source, but do not yet start external data source.
4. Switch off digital standard using STATE - OFF.
5. Set TRIGGER MODE ARMED_AUTO.
In this state, SMIQ is ready for reception, but discards data that are read in via SERDATA.
6. Switch on digital standard with STATE ON.
7. Start external data source.
The read-in data are written into the receiving buffer. Only if this buffer is filled can SMIQ react to a trigger event.
8. Activate trigger event. Signal generation is thus started at a frame limit. The first bit received via SERDATA is put to the first bit position in the selected data field.

2.16.5 Menu DIGITAL STANDARD - DECT

Menu DIGITAL STD - DECT provides access to settings for generating DECT signals.

Menu selection: DIGITAL STD - DECT

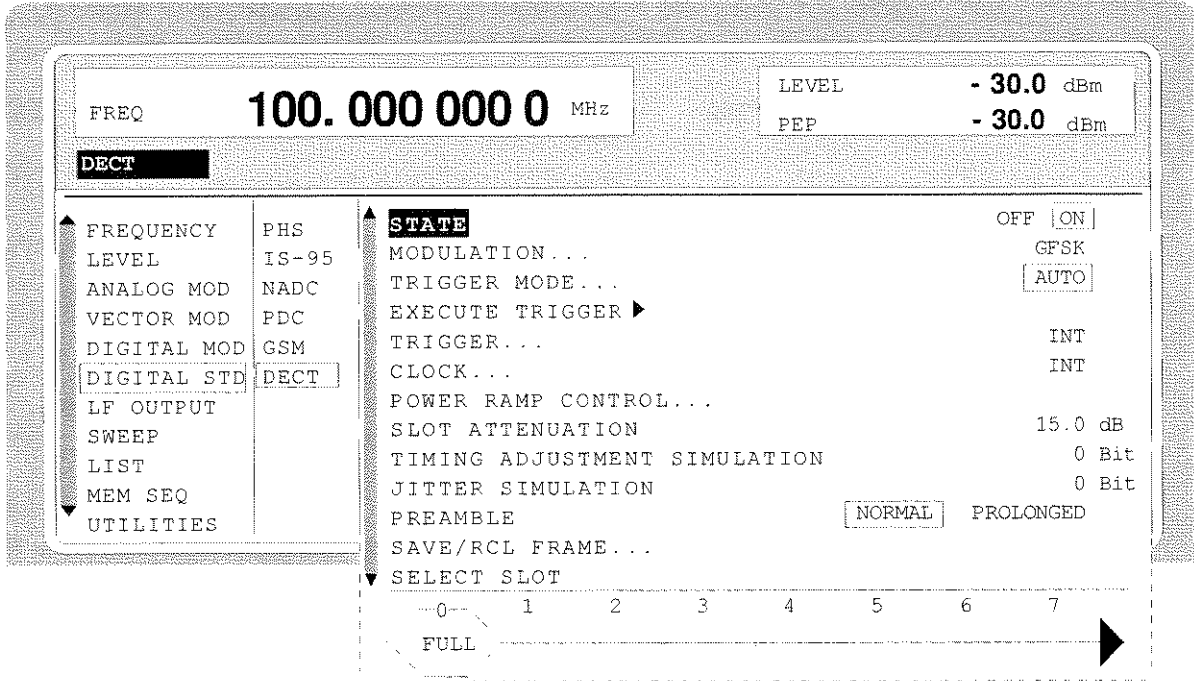

Fig. 2-109 Menu DIGITAL STD - DECT, SMIQ equipped with Modulation Coder SMIQB10 and Data Generator SMIQB11

STATE Switch on/off of Digital Standard DECT modulation. Vector Modulation or Digital Modulation will be switched off automatically.
IEC/IEEE-bus command SOUR:DECT:STAT ON

MODULATION... Opens a window for setting some of the modulation parameters.

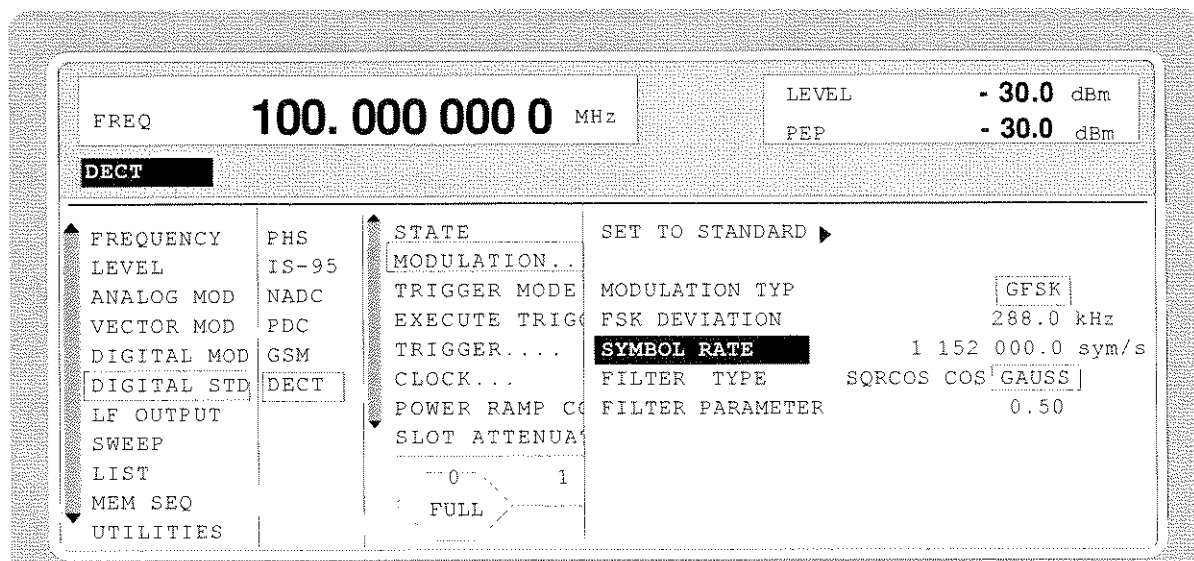

Fig. 2-110 Menu DIGITAL STD - DECT - MODULATION...

(MODULATION...)	SET TO STANDARD ►	<p>Sets the subsequent modulation parameters to the values predefined by the standard.</p> <p>IEC/IEEE-bus :SOUR:DECT:STAN</p>
	MODULATION TYPE	<p>Selection of the modulation type. GFSK is preset.</p> <p>IEC/IEEE-bus :SOUR:DECT:FORM GFSK</p>
	FSK DEVIATION	<p>Input value for the frequency deviation for GFSK modulation</p> <p>IEC/IEEE-bus :SOUR:DECT:FSK 280 KHZ</p>
	SYMBOL RATE	<p>Input value for the symbol rate. 1152 ksymbols/s are preset.</p> <p>IEC/IEEE-bus :SOUR:DECT:SRAT 1151 KHZ</p>
	FILTER TYPE	<p>Selection of baseband filter.</p> <p>For $\pi/4$ DQPSK modulation, a selection between Nyquist filters COS and SQRCOS is possible.</p> <p>IEC/IEEE-bus :SOUR:DECT:FILT:TYPE COS</p>
	FILTER PARAMETER	<p>Input value for the BT value for Gauss filtering or for the roll-off factor for Nyquist filtering.</p> <p>IEC/IEEE-bus SOUR:DECT:FILT:PAR 0.51</p>
TRIGGER MODE...		<p>Opens a window for selecting the trigger mode.</p>
	AUTO	<p>The DECT signals are continuously transmitted in the activated slots.</p> <p>IEC/IEEE-bus command SOUR:DECT:SEQ AUTO</p>
	RETRIG	<p>The DECT signals are continuously transmitted in the activated slots. A trigger event causes a restart. This mode is not available if values different from zero are set for TIMING ADJUSTMENT or JITTER SIMULATION.</p> <p>IEC/IEEE-bus command :SOUR:DECT:SEQ RETR</p>
	ARMED_AUTO	<p>DECT signal generation does not start until a trigger event has occurred. The unit then automatically switches over to the AUTO mode and can no longer be triggered.</p> <p>IEC/IEEE-bus command :SOUR:DECT:SEQ AAUT</p>
	ARMED_RETRIG	<p>DECT signal generation does not start until a trigger event has occurred. The unit then automatically switches over to the RETRIG mode. Each new trigger event causes a restart. This mode is not available if values different from zero are set for TIMING ADJUSTMENT or JITTER SIMULATION.</p> <p>IEC/IEEE-bus command :SOUR:DECT:SEQ ARET</p>

EXECUTE TRIGGER ► Executes a trigger even to start the DECT signal generation. This menu item is not available if TRIGGER MODE - AUTO is set.

IEC/IEEE-bus command : TRIG:DM IMM

TRIGGER... Opens a window for selecting the trigger source, for configuring the trigger output signals and for setting the time delay of an external trigger signal.

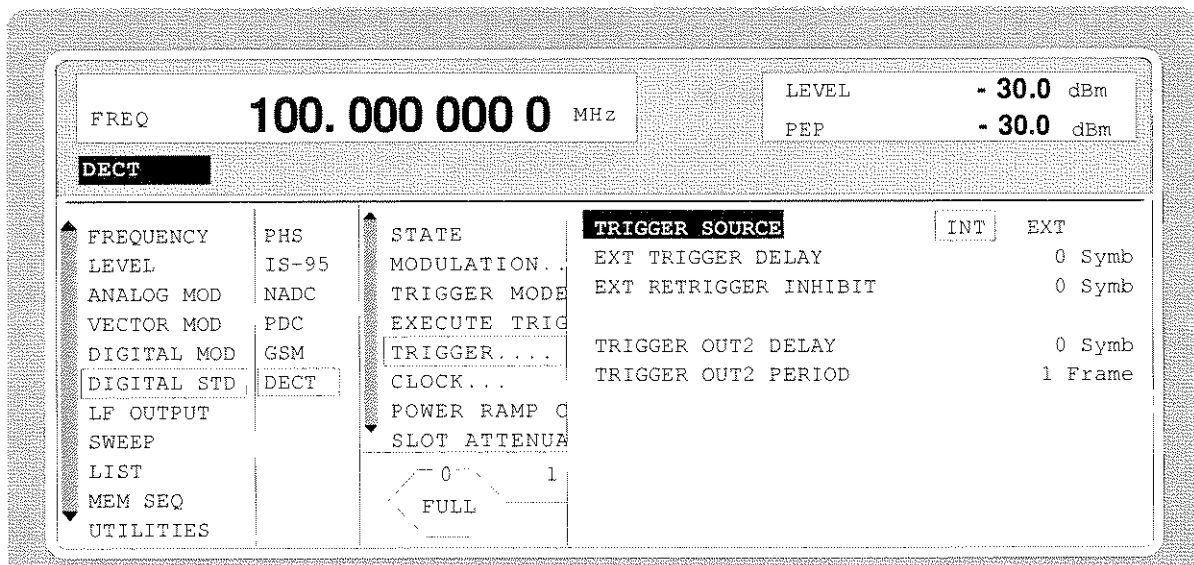

Fig. 2-111 Menu DIGITAL STD - DECT_TRIGGER..., SMIQ equipped with Modulation Coder SMIQB10 and Data Generator SMIQB11

(TRIGGER...) TRIGGER SOURCE Selection of trigger source.

EXT The DECT signal generation is started by the active slope of an external trigger signal. The polarity, the trigger threshold and the input resistance of the TRIGIN input can be modified in menu DIGITAL MOD - EXT INPUTS.

DECT A trigger event can be executed by EXECUTE TRIGGER ►.

IEC/IEEE-bus : SOUR:DECT:TRIG:SOUR EXT

EXT TRIGGER DELAY Setting the number of symbols by which an external trigger signal is delayed before it starts the DECT signal generation. This is used for setting the time synchronization between the SMIQ and the DUT.

IEC/IEEE-bus : SOUR:DECT:TRIG:DEL 3

(TRIGGER...)

**EXT RETRIGGER
INHIBIT**

Setting the number of symbols for which a restart is inhibited after a trigger event.
With TRIGGER MODE RETRIG selected, each new trigger signal restarts the DECT signal generation. This restart can be inhibited for the entered number of symbols.

Example:

The entry of 1000 symbols causes new trigger signals to be ignored for the duration of 1000 symbols after a trigger event

IEC/IEEE-bus :SOUR:DECT:TRIG:INH 1000

**TRIGGER OUT 2
DELAY**

Input value of delay of trigger signal at TRIGOUT 2 output compared with beginning of frame.

IEC/IEEE-bus :SOUR:DECT:TRIG:OUTP:DEL 2

**TRIGGER OUT2
PERIOD**

Input value of output signal period at TRIGOUT 2 output given in frames.

IEC/IEEE-bus :SOUR:DECT:TRIG:OUTP:PER 1

CLOCK... Opens a window for selecting the clock source and for setting a delay.

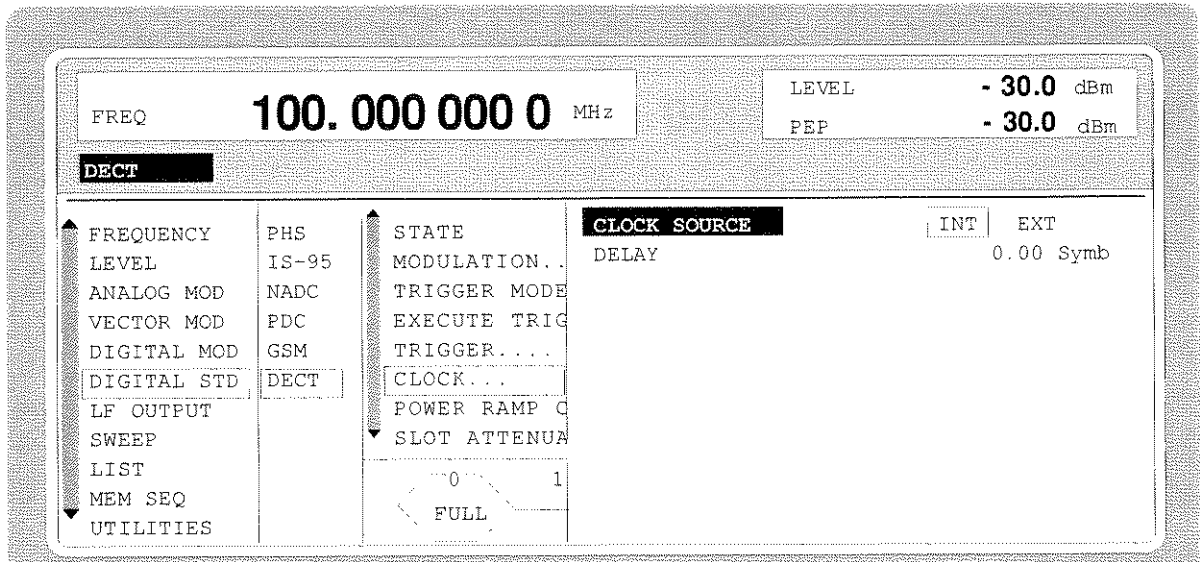

Fig. 2-112 Menu DIGITAL STD - DECT - CLOCK..., SMIQ equipped with Modulation Coder SMIQB10 and Data Generator SMIQB11

(CLOCK...)

CLOCK SOURCE

Selection of clock source.

INT SMIQ uses internally generated clock signals.

EXT An external symbol clock or bit clock is fed in at connectors SYMBOL CLOCK or BIT CLOCK. The clock synthesizer on the modulation coder is synchronized to this clock.

The symbol rate has to be set with an accuracy of $\pm 1\%$.

The polarity, the trigger threshold and the input resistance of the clock inputs can be modified in menu DIGITAL MOD - EXT INPUTS.

IEC/IEEE-bus command :SOUR:DECT:CLOC:SOUR INT

DELAY

Setting the delay of generated modulation signal to an external clock.

This can be used, for example, for synchronization with a second unit to achieve time synchronization between the modulation signals of the two units.

IEC/IEEE-bus command :SOUR:DECT:CLOC:DEL 0.5

POWER RAMP CONTROL...

Opens a window for setting the envelope control, especially for the rising and falling ramp at the beginning and end of a slot.

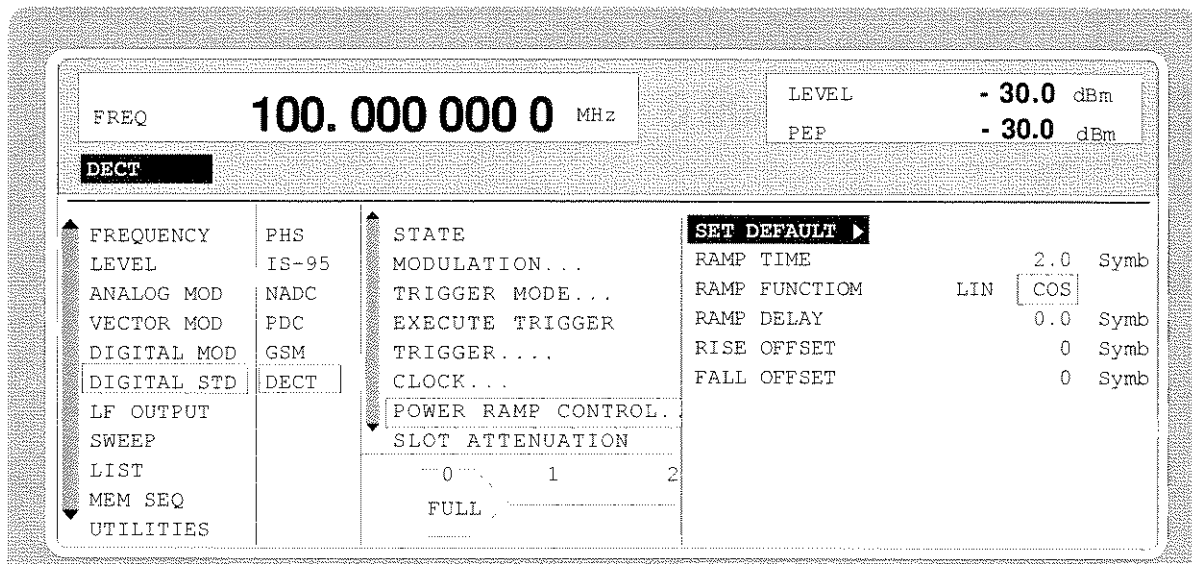

Fig. 2-113 Menu DIGITAL STD - DECT - POWER RAMP CONTROL... , SMIQ equipped with Modulation Coder SMIQB10 and Data Generator SMIQB11

(POWER RAMP CONTROL...)

SET DEFAULT

Sets the subsequent parameters to factory-set default values.

IEC/IEEE-bus SOUR:DECT:PRAM:PRES

RAMP TIME

Input value for the rise and fall time of the envelope at the beginning or end of a slot. The time is set in units of the symbol period.

IEC/IEEE-bus SOUR:DECT:PRAM:TIME 1.5

RAMP FUNCTION

Selection of shape of rising and falling ramp for envelope control.

LIN Linear ramp function.

COS Cosine function. A more favorable spectrum than that of the LIN function is obtained.

IEC/IEEE-bus SOUR:DECT:PRAM:SHAP LIN

RAMP DELAY

Input value for a shift of the envelope characteristic to the modulated signal. A positive value causes a delay of the envelope. The values are set in units of the symbol length.

IEC/IEEE-bus SOUR:DECT:PRAM:DEL 0.1

RISE OFFSET

Input value for a positive or negative offset of the rising ramp of the envelope at the beginning of a slot.

IEC/IEEE-bus SOUR:DECT:PRAM:ROFF -1

FALL OFFSET

Input value for a positive or negative offset of the falling ramp of the envelope at the end of a slot.

IEC/IEEE-bus : SOUR:DECT:PRAM:FOFF 1

- SLOT ATTENUATION** Input value for the level attenuation in dB of all active slots whose SLOT LEVEL was set to ATTN. The slots whose level is to be attenuated are defined in the menu SELECT SLOT.
IEC/IEEE-bus command : SOUR:DECT:SLOT:ATT 40 DB
- TIMING ADJUSTMENT SIMULATION** Input value for the number of bits used for simulating "Timing Adjust" in DECT instruments. Each 35th frame is extended (positive input values) or shortened (negative values) by the number of bits set.
IEC/IEEE-bus command : SOUR:DECT:SIM:TADJ -1
- JITTER SIMULATION** Input value for the number of bits used for jitter simulation. A jitter is simulated by advancing the selected number of bits for even-numbered frames in time whereas ordinary timing is generated for odd-numbered frames.
IEC/IEEE-bus command : SOUR:DECT:SIM:JITT 1
- PREAMBLE** Selection of the preamble type for full and double slot.
NORMAL The preamble field has a length of 16 bits.
PROLONGED The preamble field has a length of 32 bits.
IEC/IEEE-bus command : SOUR:DECT:PRE NORM

SAVE/RCL FRAME... Opens a window for saving and loading a frame configuration. Loading a frame affects all parameters that can be set under SELECT SLOT.

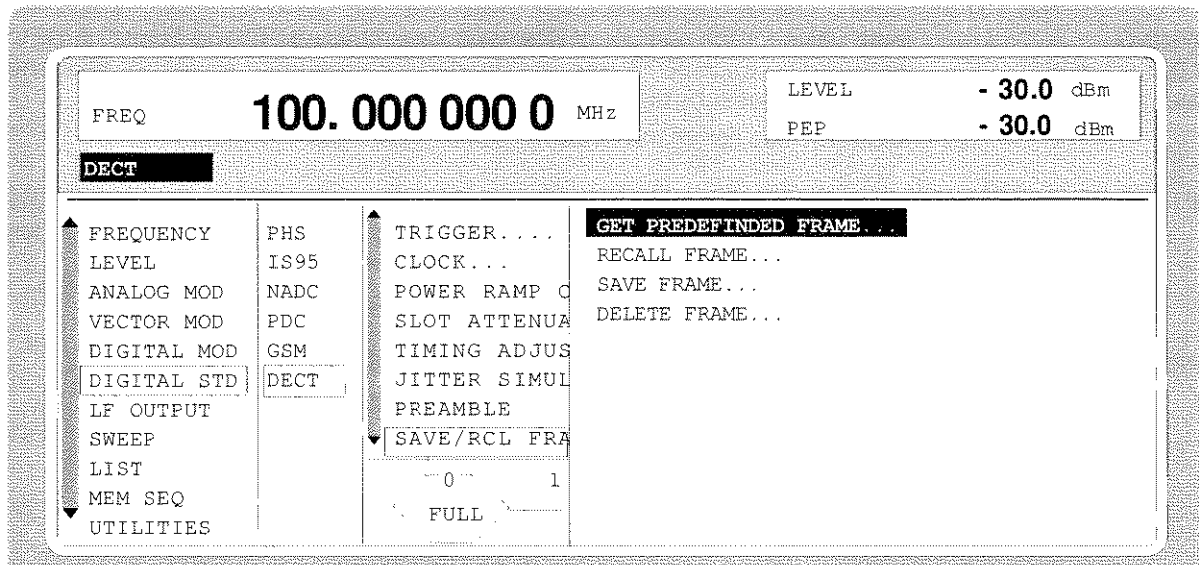

Fig. 2-114 Menu DIGITAL STD - DECT - SAVE/RCL FRAME, SMIQ equipped with Modulation Coder SMIQB10 and Data Generator SMIQB11

(SAVE/RCL FRAME...)	GET PREDEFINED FRAME...	Loads a factory-set frame configuration. DNFULL All downlink slots numbered 0 to 11 are active as full slots. UPFULL All uplink slots numbered 12 to 23 are active as full slots. FULL_0 Only slot no. 0 is active as a full slot. DOUB_0 Slots no. 0 and 1 are active as double slots. IEEE SOUR:DECT:FLIS:PRED:LOAD "name"
	RECALL FRAME...	Loads a frame configuration saved by the user. IEC/IEEE-bus SOUR:DECT:FLIS:LOAD "name"
	SAVE FRAME...	Saves a user-defined frame configuration. IEC/IEEE-bus SOUR:DECT:FLIS:STOR "name"
	DELETE FRAME...	Deletes a frame configuration saved by the user. IEC/IEEE-bus SOUR:DECT:FLIS:DEL "name"

SELECT SLOT...

Selection of one of 24 possible slots. When selecting the slot, a window is opened in which the data contents belonging to this slot can be defined. 12 slots are available for uplink and downlink, respectively. They are labeled UP<i></i> and DN<i></i> in the display where i varies from 0 to 23. Up to 12 of the 24 slots can be active at the same time.

Note: If the cursor is placed onto a slot in the diagram, the SLOT LEVEL may be modified by pressing one of the unit keys (toggle function).

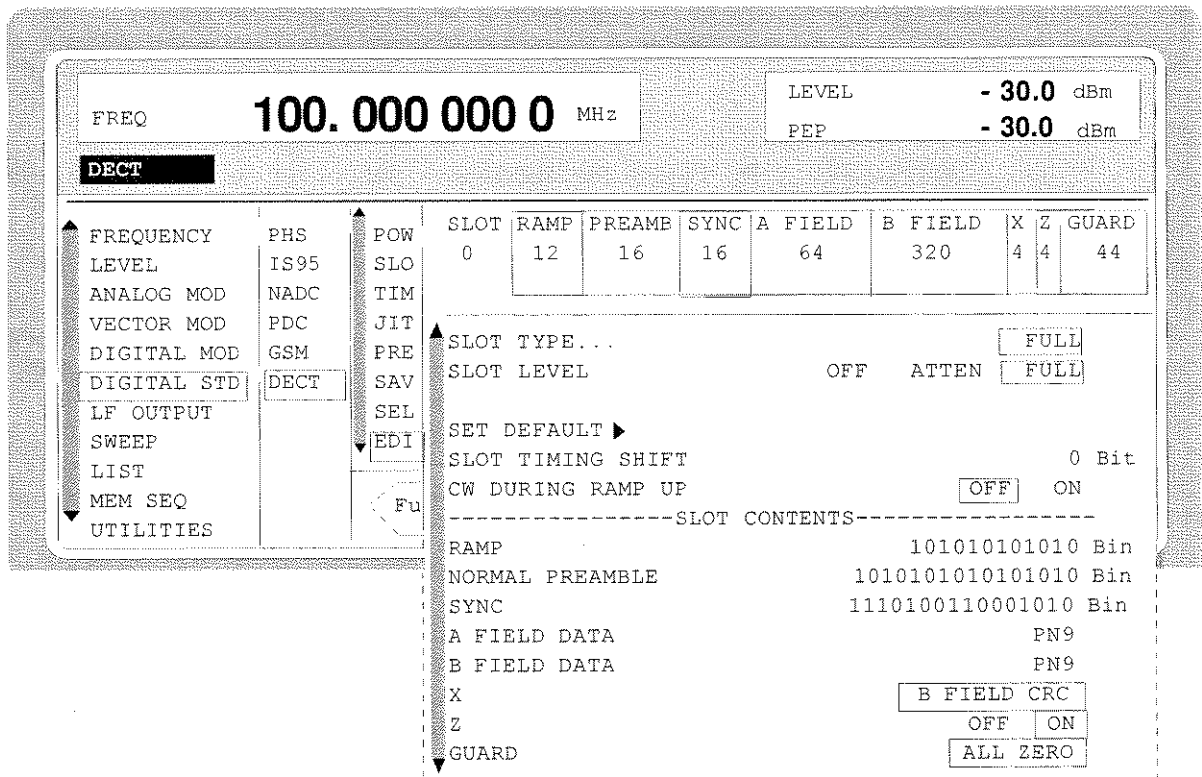

Fig. 2-115 Menu DIGITAL STD - DECT - SELECT SLOT, SMIQ equipped with Modulation Coder SMIQB10 and Data Generator SMIQB11

(SELECT SLOT)	SLOT TYPE...	Description
	FULL	Opens a window for selecting the slot type. Full slot configuration for simulating a basic R32 physical channel. IEEE-bus : SOUR:DECT:SLOT2:TYPE FULL
	DOUBLE	Double slot configuration for simulating a high capacity R80 physical channel. IEEE-bus : SOUR:DECT:SLOT2:TYPE DOUB
	ALL_DATA	SLOT type for test purposes with arbitrarily programmable data contents. IEEE-bus : SOUR:DECT:SLOT2:TYPE ADAT

(SELECT SLOT)	SLOT LEVEL	<p>Selection of the level for the selected slot.</p> <p>OFF Maximum attenuation IEEE bus : SOUR:DECT:SLOT2:LEV OFF</p> <p>FULL The level corresponds to the value indicated on the SMIQ LEVEL display. IEEE bus : SOUR:DECT:SLOT2:LEV FULL</p> <p>ATTEN The level is attenuated by the value set under SLOT ATTENUATION. IEEE bus : SOUR:DECT:SLOT2:LEV ATT</p> <p><i>Note: If the cursor is placed onto a slot in the diagram, the SLOT LEVEL may be modified by pressing one of the unit keys (toggle function).</i></p>
	SET DEFAULT ►	<p>Resets the subsequent parameters to factory-set default values.</p> <p>IEC/IEEE-bus command SOUR:DECT:SLOT8:PRES</p>
	SLOT TIMING SHIFT	<p>Input value for the number of bits used for simulating a faulty slot timing. The active slot is shifted in time by the selected number of bits. A positive input value delays the slot, a negative value advances the slot in time.</p> <p>IEEE bus command : SOUR:DECT:SLOT2:STSH 1</p>
	CW DURING RAMP UP	<p>Switches the modulation during the rise of the power ramp on or off.</p> <p>ON Before the preamble starts, the modulation is switched off so that only the unmodulated carrier is generated.</p> <p>OFF Before the preamble starts, the modulation is switched on and the data bits in the ramp field are modulated.</p> <p>IEEE bus command : SOUR:DECT:SLOT2:RAMP:CW ON</p>
	RAMP	<p>Input value for the 12-bit data field RAMP in binary format. This data field is not defined in the DECT standard. It is used to define the data contents during the rise of the power ramp. A series of data representing the natural extension of the preamble bits in forward direction is set by default.</p> <p>IEC : SOUR:DECT:SLOT2:RAMP:DATA #B111111111111</p>
	NORMAL PREAMBLE	<p>Input value for the NORMAL PREAMBLE in binary format. According to the DECT standard, the default setting for this 16-bit data field is different for uplink and downlink slots. This data field is not available for slot type ALL_DATA.</p> <p>IEEE : SOUR:DECT:SLOT2:PRE:DATA #B1010...</p>
	PROLONGED PREAMBLE	<p>Input value for the PROLONGED PREAMBLE in binary format. According to the DECT standard, the default setting for this 32-bit data field is different for uplink and downlink slots. This data field is not available for slot type ALL_DATA.</p> <p>IEEE : SOUR:DECT:SLOT2:PRE:PROL:DATA #B1010...</p>

(SELECT SLOT)	SYNC	<p>Input value for the 16-bit data field SYNC in binary format. According to the DECT standard, the default setting for this 32-bit data field is different for uplink and downlink slots. This data field is not available for slot type ALL_DATA.</p> <p>IEEE :SOURce:DECT:SLOT2:SYNC #B1001...</p>
	A FIELD DATA	<p>Selection of the data source for the A FIELD. The 64-bit A data field is only displayed for the slot types FULL and DOUBLE.</p> <p>PN.. PRBS data according to CCITT V52 or Rec. 0.151 with period lengths between 2^9-1 and $2^{23}-1$.</p> <p>IEEE bus :SOUR:DECT:SLOT3:AFI PN15</p> <p>DLIST Data from a programmable list.</p> <p>IEEE bus :SOUR:DECT:DLIS "name" :SOUR:DECT:SLOT3:AFI DLIS</p> <p>SERDATA Data fed in via the entry SER DATA.</p> <p>IEEE-bus :SOUR:DECT:SLOT3:AFI SDAT</p>
	B FIELD DATA	<p>Selection of the data source for the B FIELD. The B data field is only displayed for the slot types FULL and DOUBLE. Its length is 320 bits for full slot and 800 bits for double slot.</p> <p>PN.. PRBS data according to CCITT V52 or Rec. 0.151 with period lengths between 2^9-1 and $2^{23}-1$.</p> <p>IEE-bus :SOUR:DECT:SLOT3:BFI PN15</p> <p>DLIST Data from a programmable list.</p> <p>IEEE-bus :SOURce:DECT:DLIS "name" :SOUR:DECT:SLOT3:BFI DLIS</p> <p>SERDATA Data fed in via the entry SER DATA.</p> <p>IEEE-bus :SOUR:DECT:SLOT3:BFI SDAT</p>
	DATA	<p>Selection of the data source for the 424-bit data field DATA. The B data field is only displayed for the slot type ALL_DATA.</p> <p>PN.. PRBS data according to CCITT V52 or Rec. 0.151 with period lengths between 2^9-1 and $2^{23}-1$.</p> <p>IEEE-bus :SOUR:DECT:SLOT3:DATA PN15</p> <p>DLIST Data from a programmable list.</p> <p>IEEE-bus :SOUR:DECT:DLIS "name" :SOUR:DECT:SLOT3:DATA DLIS</p> <p>SERDATA Data fed in via the entry SER DATA.</p> <p>IEEE-bus :SOUR:DECT:SLOT3:DATA SDAT</p>
	X	<p>This 4-bit data field can not be edited. It contains a CRC (Cyclic Redundancy Code) generated from the data in the B data field according to the DECT standard. This data field is not available for slot type ALL_DATA.</p>

Z Switches the Z field on and off. This function is available for the slot types FULL and DOUBLE.

ON The CRC (Cyclic Redundancy Code) generated for the X field is repeated in the 4-bit data field Z.

OFF The Z field is not activated. The guard field is extended by 4 bits.

IEEE-bus command :SOUR:DECT:SLOT2:ZFI ON

GUARD This data field can not be edited and contains zero data. At the beginning of the GUARD field, the power ramp of the active slot starts falling.

2.17 External Modulation Source AMIQ - AMIQ CTRL

AMIQ from Rohde&Schwarz is now available as an external source for I/Q modulation signals. The generated signals are provided by the unit at modulation outputs I and Q on the front panel. The signals can be fed to modulation inputs I and Q of SMIQ.

With vector modulation mode activated, SMIQ modulates (I/Q modulation) the modulation signals generated by AMIQ onto the RF carrier.

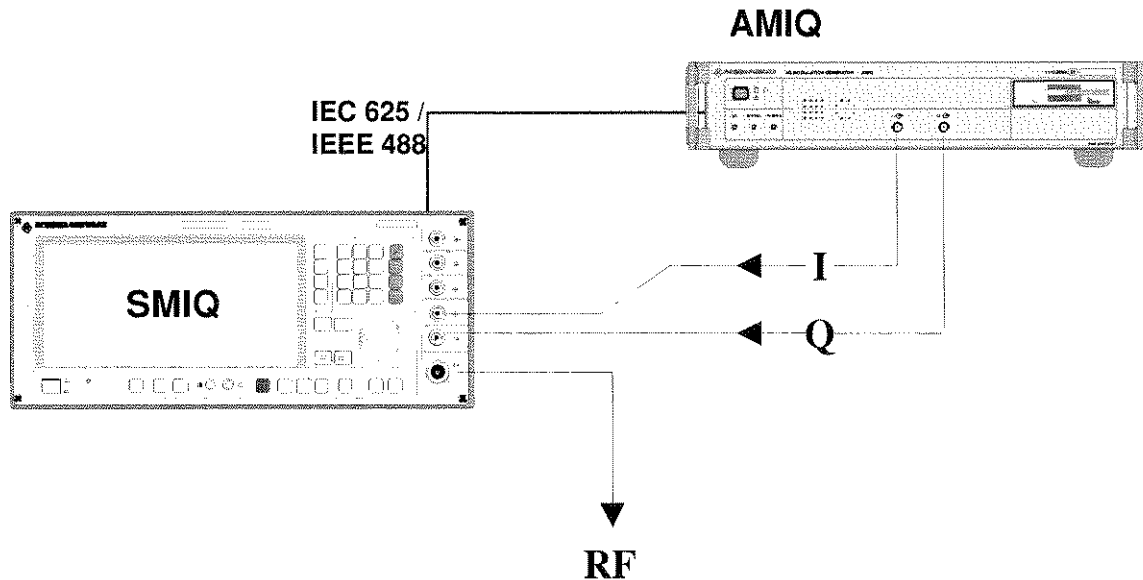

Fig. 2-116 Vector modulation with an external AMIQ

Menu VECTOR MOD provides access to settings required for vector modulation. Settings for generating the modulation signals are made in menu AMIQ CTRL. This menu allows to set the most important parameters of AMIQ via the remote-control interface IEC625/IEEE488. The IEC/IEEE-bus address of AMIQ is given in menu UTILITIES / SYSTEM / GPIB.

Note: *Menu AMIQ CTRL is masked out when SMIQ is delivered. It has to be switched on in menu UTILITIES / INSTALL.*



Complex signal data are created on the PC using Windows software WinIQSIM and are stored on the AMIQ hard disk or on floppy. With SMIQ, these signal data can be stored on hard disk and loaded into the internal memory.

The system consisting of SMIQ as modulation coder, AMIQ as source for baseband signals and WinIQSIM for signal data configuration makes the generation of any complex, digitally modulated communication signals convenient and easy.

To remote control AMIQ via IEC625/IEEE488, SMIQ is configured as a system controller. In the normal mode, SMIQ is configured as a talker/listener.

In general, only one unit can be the system controller on the bus.

With menu AMIQ CTRL called up, SMIQ is automatically configured as the controller. If this is not possible since for example another unit (eg a PC) has already taken over the controller function, menu AMIQ CTRL will not be opened and an error message will be issued.

When menu AMIQ CTRL is closed, SMIQ will again switch to the talker/listener mode.

Menu selection: AMIQ CTRL

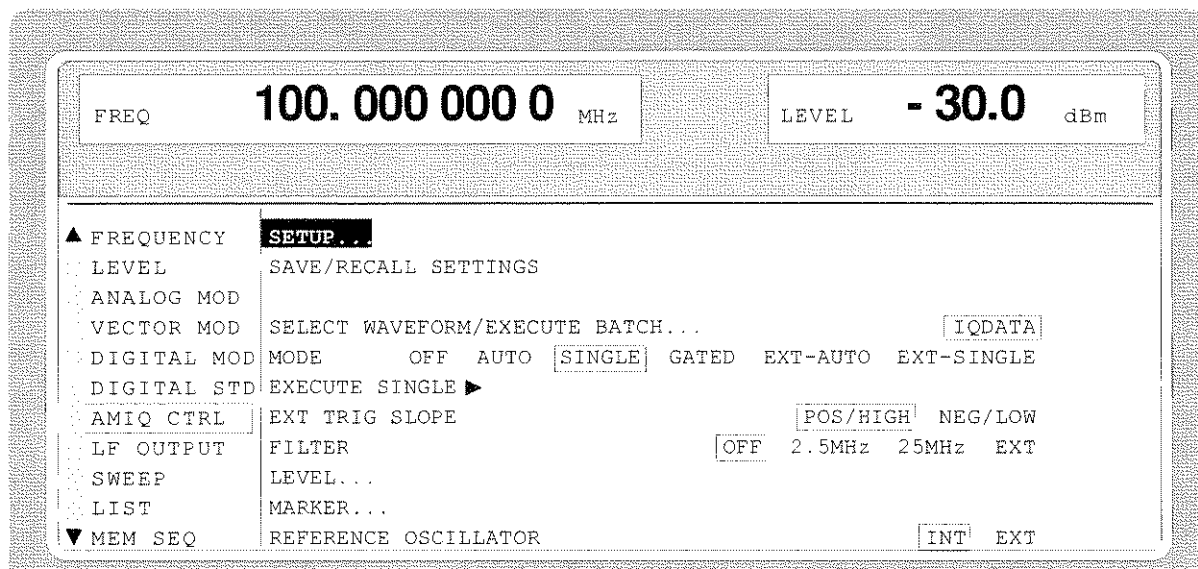

Fig. 2-117 Menu AMIQ CTRL (presetting depends on AMIQ)

SETUP...

Opens a window to set the basic configuration of AMIQ.

The window offers functions to perform automatic adjustment, fine adjustment, selftest and to reset to a defined basic state.

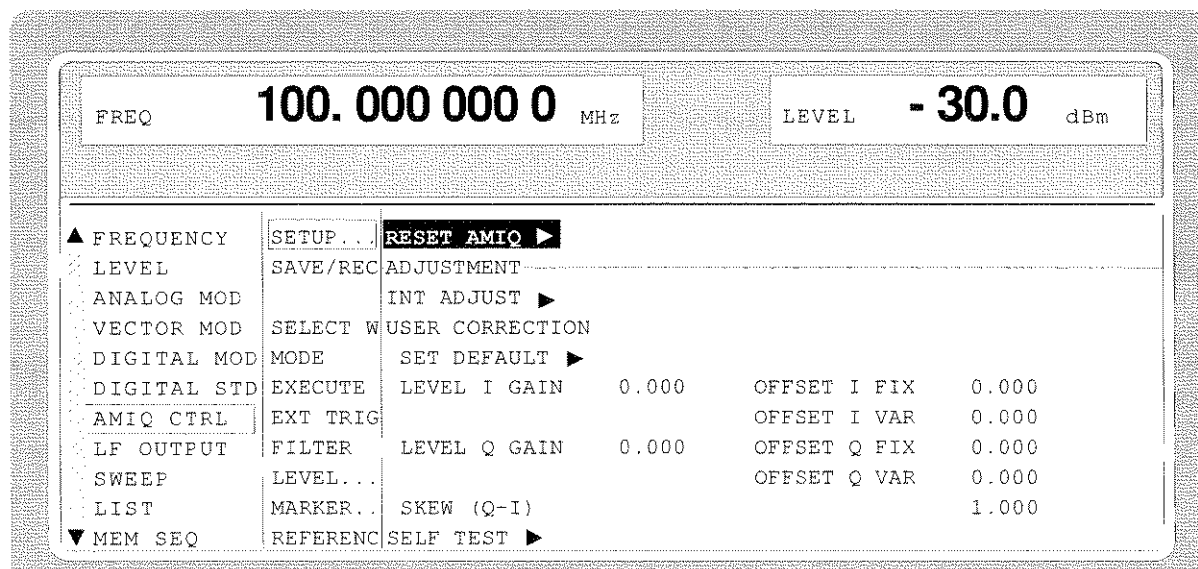

Fig. 2-118 Menu AMIQ CTRL -SETUP...

(SETUP...)	RESET AMIQ ►	Resets AMIQ to a defined basic state.
	INT ADJUST ►	Starts automatic self-adjustment of AMIQ: <ul style="list-style-type: none"> – Level adjustment (I/Q) to 1.0 Volt when fully equipped – Offset adjustment (I/Q) to a minimum – Fine adjustment of reference oscillator to 10 MHz – Minimization of delay between I and Q channel
	USER CORRECTION	The user correction allows the fine adjustment of level and offset of the I and Q channel as well as the minimization of the delay between the channels of the complete system. The internal adjustment (INT ADJUST) is not taken into account.
	SET DEFAULT ►	Resets the user correction to the default values. This applies to the following parameters: <ul style="list-style-type: none"> – LEVEL I GAIN (*) – OFFSET I FIX (*) – OFFSET I VAR (**) – LEVEL Q GAIN (*) – OFFSET Q FIX (*) – OFFSET Q VAR (**) – SKEW (I-Q) <p>* These parameters will only be effective provided that a fixed level of 0.5 V/50 Ohm has been assigned to the corresponding channel. For variable levels, the settings of these parameters are ineffective. A correction of the gain factor is possible when the level is entered.</p> <p>** These parameters are only effective in case of variable levels and have no effect in case of fixed levels.</p> <p>The level is set in the submenu LEVEL... (LEVEL I/Q = 0.5V/50 Ohm or VAR).</p>
	LEVEL I GAIN	Fine adjustment of gain factor for I channel in case of fixed level. Relative gain factors in the range $\pm 10\%$ can be entered.
	OFFSET I FIX	Fine adjustment of level offset for the I channel in case of fixed level. The relative factors ± 1.0 correspond to a an offset detuning of ± 30 mV.
	OFFSET I VAR	Fine adjustment of level offset for the I channel in case of variable level. The offset detuning depends on the of the mechanical attenuator setting of AMIQ. See AMIQ manual, section SOURce - Hardware Settings.
	LEVEL Q GAIN	Fine adjustment of gain factor for the Q channel in case of fixed level.

(SETUP...)	OFFSET Q FIX	Fine adjustment of level offset for the Q channel in case of fixed level.
	OFFSET Q VAR	Fine adjustment of level offset for the Q channel in case of variable level.
	SKEW (Q-I)	Defining the delay between the I and Q channel. Positive values delay I compared with Q. The delay can be modified by entering the relative factors ± 1.0 in a range of approx. ± 1 ns at a resolution of 10 ps.
	SELF TEST ►	Triggers the internal AMIQ selftest which comprises the following: <ul style="list-style-type: none"> - memory test of the output memory. - control of components of analog software and check of signal paths by means of the built-in diagnostic A/D converter.

SAVE/RECALL SETTINGS... Opens a window to save/load/delete a maximum number of 100 AMIQ setups.

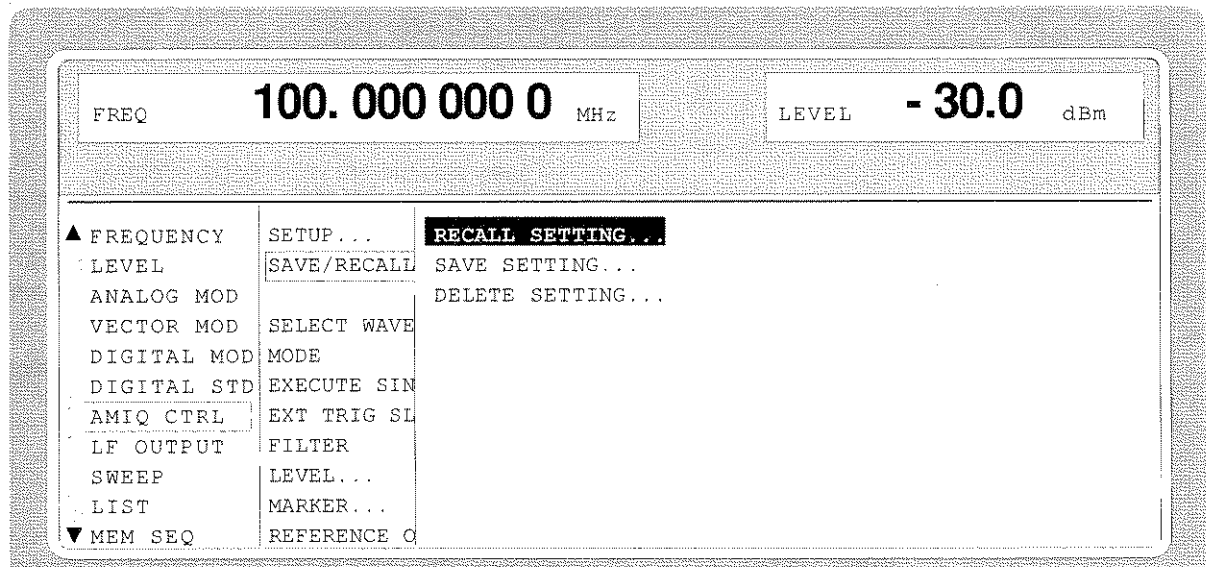

Fig. 2-119 Menu AMIQ CTRL -SAVE/RECALL SETTINGS...

(SAVE/RECALL SETTINGS...)	RECALL SETTING...	Selects and loads a stored AMIQ setup. The available setups are offered in a select window.
	SAVE SETTING...	Saves the current AMIQ setup. An already existing setup can be selected and overwritten in a select window. A new setup is created by selecting CREATE NEW SETTING ►. SMIQ automatically offers SETTxx with xx being in the range from 0 to 99. This name can be modified any time as required.
	DELETE SETTING...	Deletes AMIQ setups. The available setups are offered in a select window.

SELECT WAVEFORM/ EXECUTE BATCH... Opens a window to

- load signal data from diskette or hard disk into the AMIQ internal memory,
- transfer signal data generated by WinIQSIM to the AMIQ hard disk,
- display current signal data.

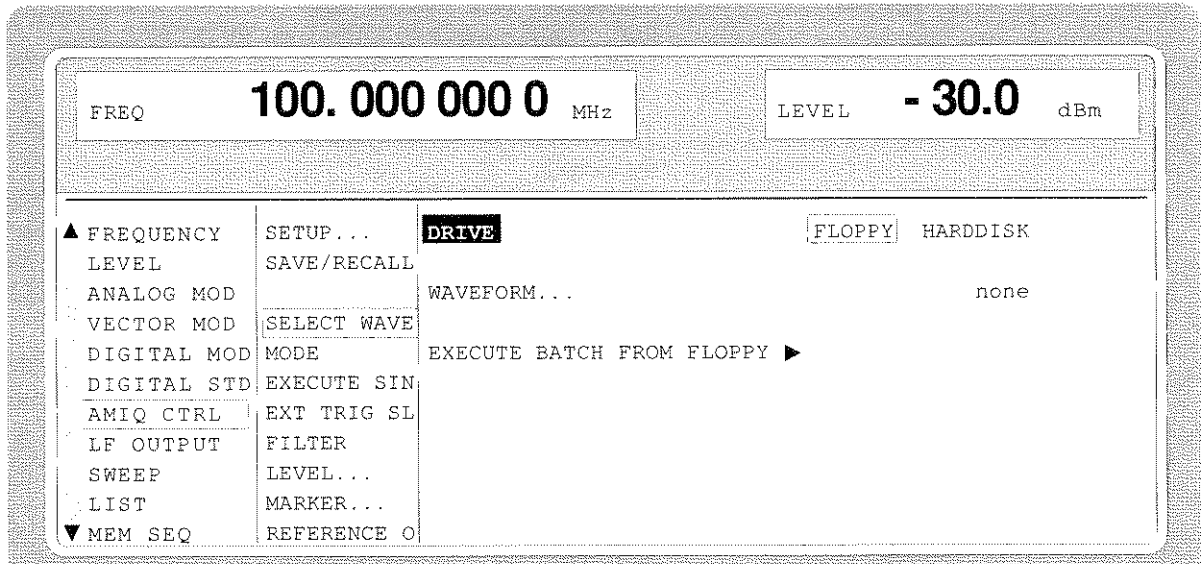

Fig. 2-120 Menu AMIQ - SELECT WAVEFORM/EXECUTE BATCH...

(SELECT WAVEFORM/ EXECUTE BATCH...)

DRIVE

Selects storage medium with the signal data to be activated.

DIRECTORY...

Selects the directory comprising the required signal data on the AMIQ hard disk. The directory structure is freely selectable and can be modified with WinIQSIM. SMIQ does not allow to change the directory structure. The menu item is only visible with DRIVE = HARDDISK.

WAVEFORM...

Selects the signal data to be loaded. The data available on diskette or hard disk are offered in a select window. After selecting the signal data, the following actions are performed:

1. stopping the currently active signal output,
2. preparing the selected signal data,
3. further procedure is according to parameter MODE in main menu.

EXECUTE BATCH FROM FLOPPY ►

Executes the batch file WINIQSIM.IEC generated by WinIQSIM from diskette. The signal data including the given directory structure are stored on the AMIQ hard disk. The directory structure is defined by the user during the generation of the diskette.

MODE	Configuration of trigger conditions for signal output. Any change in the trigger conditions resets the signal output and starts it again. Retriggering a running signal output is inhibited.
OFF	Stops the signal output, output of the idle signal.
AUTO	Continuous signal output, trigger events are ignored.
SINGLE	Prepares a single signal output. The idle signal is output first. Signal output is started via menu item EXECUTE SINGLE ►. After completion of the signal output, the idle signal is output. External trigger events are ignored.
GATED	The level of the signal applied to the trigger input controls the output. If the level (HIGH/LOW) set under EXT TRIG SLOPE is applied, the signal output will be restarted and the signal will be output continuously. If the level set under EXT TRIG SLOPE is not applied, the output will be interrupted and the idle signal will be output.
EXT-AUTO	Continuous signal output. The idle signal is output first. The signal output is started via an external trigger event. Further trigger events are ignored. A signal slope whose polarity is configured in menu item EXT TRIG SLOPE (POS/NEG) is taken as a trigger event.
EXT-SINGLE	Prepares a single signal output. The idle signal is output first. The signal output is started via an external trigger event. After completion of the signal output, the idle signal is output until the next trigger event is obtained.
EXECUTE SINGLE ►	Starts a single signal output. This menu item is displayed only with MODE = SINGLE.
EXT TRIG SLOPE	Selects the polarity of an external trigger signal at connector TRIG. This external trigger signal generates a trigger event. This setting has an effect on modes GATED (HIGH/LOW), EXT-AUTO and EXT-SINGLE (POS/NEG).
FILTER	Configuration of reconstruction filters for signal paths I and Q.
OFF	Output of unfiltered I/Q signals
2.5MHz	Loop in of the internal 2.5 MHz lowpass filter.
25MHz	Loop in of the internal 25 MHz lowpass filter
EXT	Loop in of external bandpass filters for the I and Q channel. For a detailed specification of the filter see AMIQ manual, section Signal Inputs and Outputs.
Note:	<i>With external filtering it has to be made sure that a filter is connected to both filter inputs I and Q on the rear of AMIQ. The two signal outputs can be switched off completely during external filtering provided that no filter is connected to the corresponding filter input.</i>

LEVEL... Opens a window to set the level for the two signal paths I and Q.

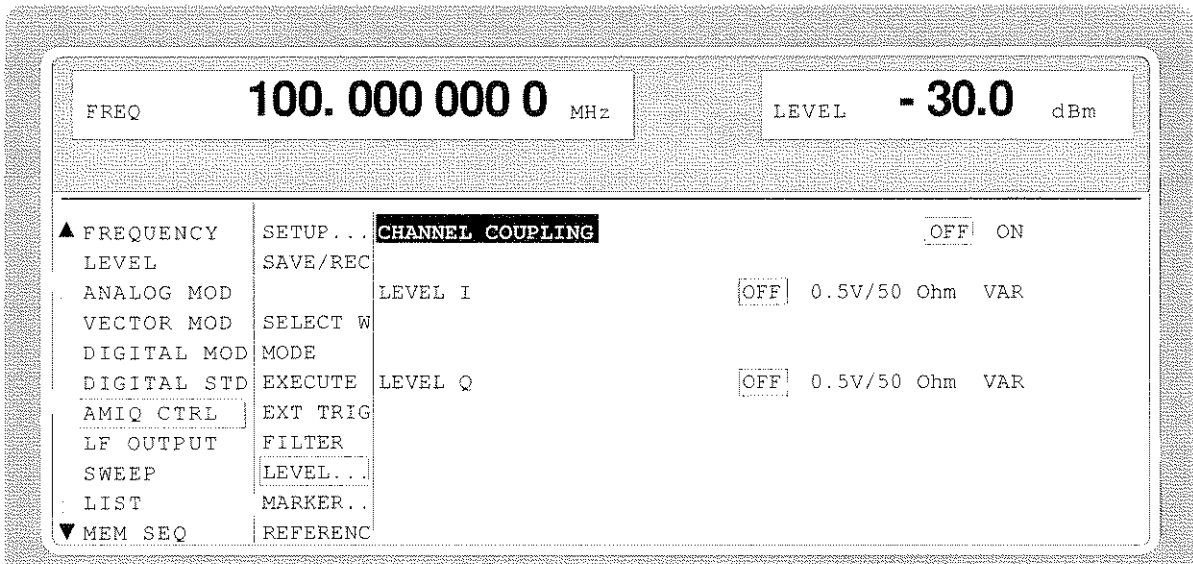

Fig. 2-121 Menu AMIQ CTRL -LEVEL...

- (LEVEL...)**
- CHANNEL COUPLING** Switches on/off coupling of level setting for the I and Q channel.
 - OFF Separate setting of the two channels
 - ON Combined setting of the two channels
- LEVEL I/Q** Selection of level setting for the I/Q channel.
 - OFF Switch-off of output
 - 0.5V/50Ohm Fixed setting of 1 V_{pp} into 50 Ohm
 - VAR Variable setting of level
- Note:** *The fine setting of level and offset can be made in menu AMIQ CTRL - SETUP....*
- LEVEL** Variable setting of level for the I/Q channel. This menu item is displayed only with LEVEL I/Q = VAR.

MARKER... Opens a window to configure the four binary marker outputs of AMIQ (eg to control power ramping of SMIQ), see AMIQ operating manual, section Marker Outputs.

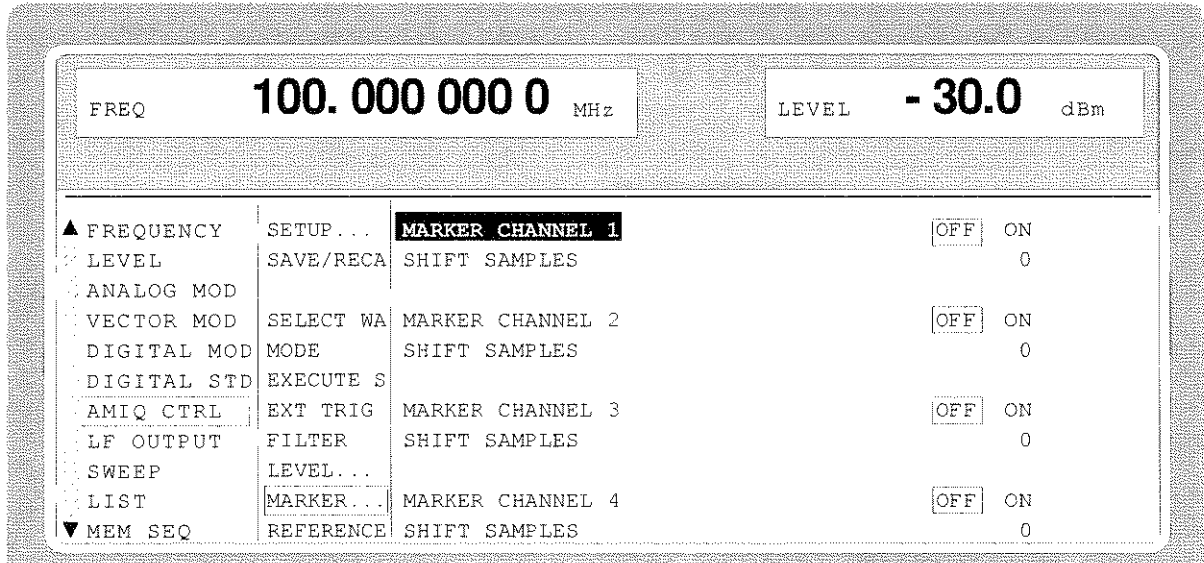

Fig. 2-122 Menu AMIQ CTRL - MARKER...

(MARKER...) **MARKER CHANNEL 1/2/3/4** Configuration of marker output 1/2/3/4.
 OFF No marker output
 ON Marker output
 SHIFT Marker output displaced by SHIFT SAMPLES.

SHIFT SAMPLES Number of samples by which the marker of the corresponding marker channel is displaced. Negative values cause the marker sequence to be started earlier while positive values make for a delay of the marker sequence.

REFERENCE OSCILLATOR Setting the synchronization by a reference clock.
 INT Use of internally generated 10 MHz clock.
 EXT The frequency can be synchronized to an external clock of 10 MHz via the REF input of AMIQ.

Note: The high-precision 10 MHz clock generated by the internal reference oscillator is always output at the REF output of AMIQ.

2.18 LF-Output

The internal LF generator is available as a signal source for the LF output.

Menu LF OUTPUT offers access to the settings of the LF output.

- Notes:** - An alteration of the frequency of the internal modulation generator in the LF-output menu automatically effects the modulation for which the generator is selected as modulation source.
- The SWEEP function of LF generator can be activated in menu SWEEP-LF-GEN.

Menu selection: LF OUTPUT

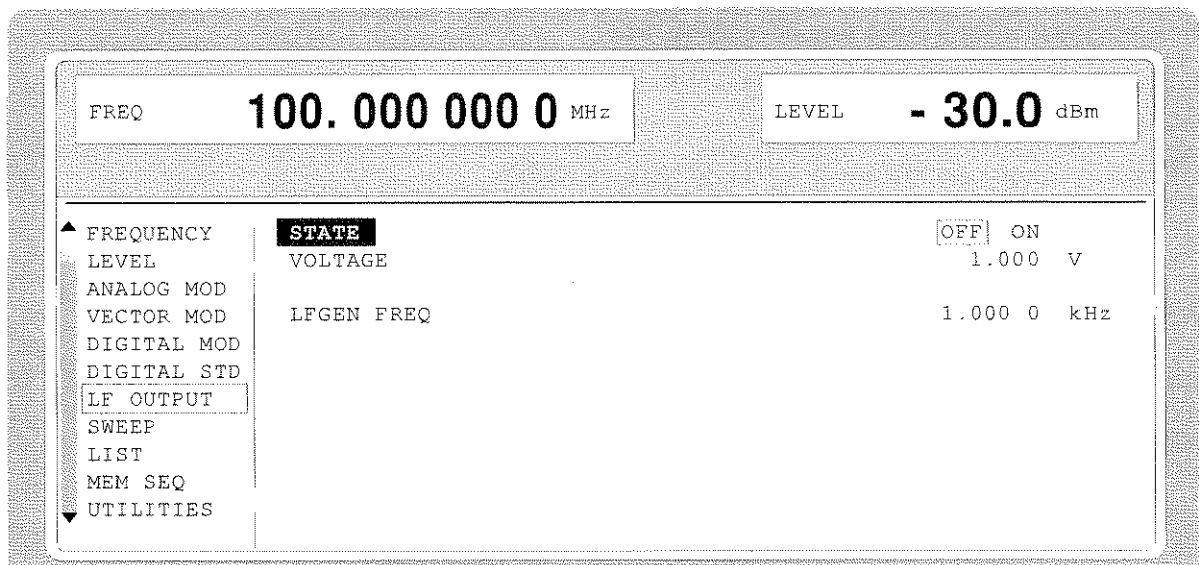

Fig. 2-123 Menu LF OUTPUT (preset setting)

STATE	Switching on/off the LF output. Parameter STATE has no influence on the modulation settings. IEC/IEEE-bus command :OUTP2 ON
VOLTAGE	Input value of the output voltage of the LF output. The input is effected in the form of a peak voltage. IEC/IEEE-bus command :OUTP2:VOLT 1V
LFGEN FREQ	Input value of the frequency of internal modulation generator. IEC/IEEE-bus command :SOUR2:FREQ 1kHz

2.19 Sweep

The SMIQ offers a digital step-by-step sweep for parameters:

- RF frequency
- LF frequency
- RF level

Setting a sweep is effected in five basic steps which are shown in the following example, the setting of a frequency sweep:

1. Set sweep range (START and STOP or CENTER and SPAN).
2. Select linear or logarithmic sequence (SPACING).
3. Set step width (STEP) and dwell time (DWELL).
4. Activate marker if desired (MARKER).
5. Switch on sweep (MODE set to AUTO, SINGLE or STEP).

2.19.1 Setting the Sweep Range (START, STOP, CENTER and SPAN)

The sweep range of the RF sweep can be entered in two different ways. Either by entering the START and STOP value or by entering CENTER and SPAN. Please observe that the two parameter sets influence one another. The influence is exerted in the following way:

START frequency altered:	STOP = unaltered
	CENTER = $(START + STOP)/2$
	SPAN = $(STOP - START)$
STOP frequency altered:	START = unaltered
	CENTER = $(START + STOP)/2$
	SPAN = $(STOP - START)$
CENTER frequency altered	SPAN = unaltered
	START = $(CENTER - SPAN/2)$
	STOP = $(CENTER + SPAN/2)$
SPAN frequency altered:	CENTER = unaltered
	START = $(CENTER - SPAN/2)$
	STOP = $(CENTER + SPAN/2)$

2.19.2 Selecting the Sweep Run (SPACING LIN, LOG)

The sweep run, linear or logarithmic, can be selected using SPACING. For the RF and LF sweep, a linear or logarithmic run is possible. For level sweep, only the logarithmic run is possible.

With the logarithmic sweep, step width STEP is equal to a constant fraction of the present setting. The logarithmic step width is entered in unit % with RF or LF sweep, in unit dB with level sweep.

2.19.3 Operating Modes (MODE)

The following sweep operating modes are available:

AUTO Sweep from the starting point to the stop point, with automatic restart at the starting point. If another sweep operating mode was activated prior to the AUTO operating mode, continuation is made from the current sweep setting.

IEC/IEEE-bus commands:

RF sweep:	LF sweep:	Level sweep:
SOUR:FREQ:MODE SWE	SOUR2:FREQ:MODE SWE	SOUR:POW:MODE SWE
SOUR:SWE:MODE AUTO	SOUR2:SWE:MODE AUTO	SOUR:SWE:POW:MODE
AUTO		
TRIG:SOUR AUTO	TRIG2:SOUR AUTO	TRIG:SOUR AUTO

SINGLE Single run from the starting point to the stop point. If SINGLE is selected, the run is not started yet. Function EXECUTE SINGLE SWEEP ► to be executed, which can be used to start the run, is displayed below the MODE line.

IEC/IEEE-bus commands:

RF sweep:	LF sweep:	Level sweep:
SOUR:FREQ:MODE SWE	SOUR2:FREQ:MODE SWE	SOUR:POW:MODE SWE
SOUR:SWE:MODE AUTO	SOUR2:SWE:MODE AUTO	SOUR:SWE:POW:MODE AUTO
TRIG:SOUR SING	TRIG2:SOUR SING	TRIG:SOUR SING

STEP Step-by-step, manual run within the sweep limits. Activating STEP stops a running sweep and the cursor wraps to the indication value of CURRENT. The sweep run can now be controlled upwards or downwards in discrete steps using the rotary knob or the numeric keys.

IEC/IEEE-bus commands:

RF sweep:	LF sweep:	Level sweep:
SOUR:FREQ:MODE SWE	SOUR2:FREQ:MODE SWE	SOUR:POW:MODE SWE
SOUR:SWE:MODE STEP	SOUR2:SWE:MODE STEP	SOUR:SWE:POW:MODE STEP
TRIG:SOUR SING	TRIG2:SOUR SING	TRIG:SOUR SING

EXT-SINGLE Single run from the starting point to the stop point as in the case of SINGLE, but triggered by an external trigger signal.

IEC-bus short commands:

RF sweep:	LF sweep:	Level sweep:
SOUR:FREQ:MODE SWE	SOUR2:FREQ:MODE SWE	SOUR:POW:MODE SWE
SOUR:SWE:MODE AUTO	SOUR2:SWE:MODE AUTO	SOUR:SWE:POW:MODE AUTO
TRIG:SOUR EXT	TRIG2:SOUR EXT	TRIG:SOUR EXT

EXT-STEP Step-by-step run by means of the external trigger signal. Each trigger event triggers a single step.

IEC-bus short commands:

RF sweep:

SOUR:FREQ:MODE SWE

SOUR:SWE:MODE STEP

TRIG:SOUR EXT

LF sweep:

SOUR2:FREQ:MODE SWE

SOUR2:SWE:MODE STEP

TRIG2:SOUR EXT

Level sweep:

SOUR:POW:MODE SWE

SOUR:SWE:POW:MODE STEP

TRIG:SOUR EXT

OFF The sweep operating mode is switched off.

IEC-bus short commands:

RF sweep:

SOUR:FREQ:MODE CW

LF sweep:

SOUR2:FREQ:MODE CW

Level sweep:

SOUR:POW:MODE CW

2.19.4 Trigger Input

An external signal at the rear input triggers the sweep in the EXT-SINGLE and EXT-STEP operating modes. The polarity of the active trigger edge can be set in menu UTILITIES - AUX I/O EXT TRIG SLOPE.

2.19.5 Sweep Outputs

Outputs X-AXIS, BLANK and MARKER are available at the rear of the instrument to control and trigger oscilloscopes or XY recorders.

X_AXIS With sweep switched on, this output supplies a voltage ramp of 0 to 10 V for the X-deflection of an oscilloscope or an XY recorder.

BLANK This output supplies a signal (0V/5V) to trigger and blank an oscilloscope or for the PEN LIFT control of an XY recorder. The polarity and the period of the signal can be set under UTILITIES - AUX I/O - BLANK POLARITY and - BLANK TIME.

MARKER

This output becomes active when the sweep run has reached the mark. The MARKER signal can be used for the brightness control of an oscilloscope. Up to three marks can be set in order to mark certain positions in the sweep run. The polarity of the signal can be set in menu UTILITIES - AUX I/O - MARKER POLARITY. The period of the active signal is equal to the dwell time (DWELL) of a step.

Signal examples:

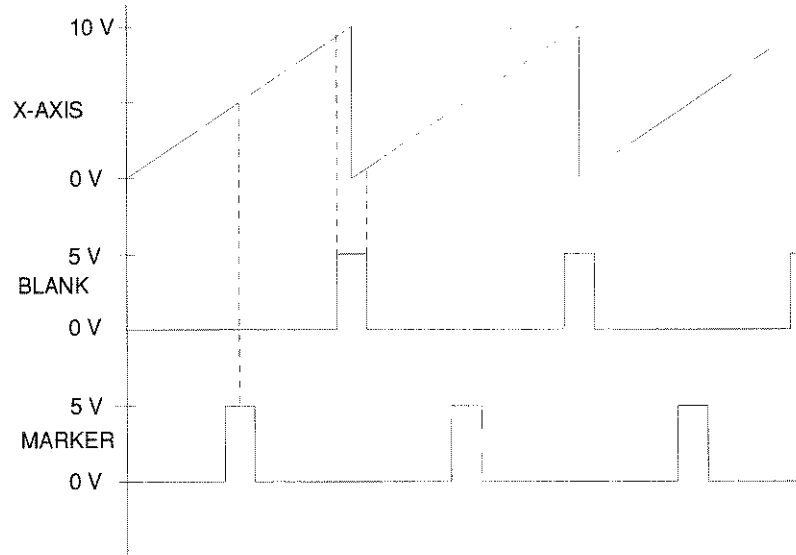

Fig. 2-124 Signal example sweep: MODE = AUTO, BLANK TIME = NORMAL

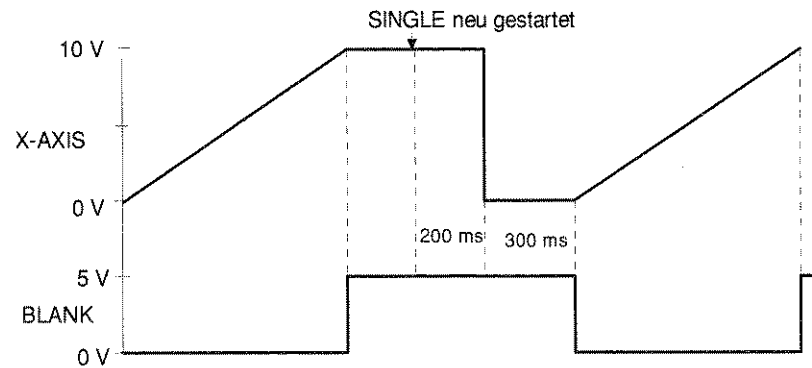

Fig. 2-125 Signal example sweep: MODE = SINGLE, BLANK TIME = LONG

2.19.6 RF-Sweep

Menu SWEEP - FREQ offers access to settings for RF sweep.

Menu selection: SWEEP - FREQ

The screenshot shows the RF-Sweep menu interface. At the top, there are two summary boxes: one for frequency (START FREQ: 100.000 000 0 MHz, STOP FREQ: 500.000 000 0 MHz) and one for level (LEVEL: -30.0 dBm). Below these is a title bar 'RF-SWP'. The main menu is divided into two columns. The left column lists menu options: FREQUENCY, LEVEL, ANALOG MOD, VECTOR MOD, DIGITAL MOD, DIGITAL STD, LF OUTPUT, SWEEP (highlighted), LIST, MEM SEQ, and UTILITIES. The right column displays the current settings for each parameter: START FREQ (100.000 000 0 MHz), STOP FREQ (500.000 000 0 MHz), CENTER FREQ (300.000 000 0 MHz), SPAN (400.000 000 0 MHz), CURRENT FREQ (100.000 000 0 MHz), SPACING (LIN LOG), STEP LIN (1.000 000 0 MHz), DWELL (15.0 ms), MODE (OFF AUTO SINGLE STEP EXT-SINGLE EXT-STEP), EXECUTE SINGLE SWEEP (with a right arrow), and RESET SWEEP (with a right arrow). At the bottom, there are three marker settings: MARKER 1 (FREQ: 100.000 0 MHz, STATE: OFF ON, AMPLITUDE: OFF ON), MARKER 2 (FREQ: 200.000 0 MHz, STATE: OFF ON, AMPLITUDE: OFF ON), and MARKER 3 (FREQ: 300.000 0 MHz, STATE: OFF ON, AMPLITUDE: OFF ON).

Fig. 2-126 Menu SWEEP - FREQ

START FREQ	Input value of the starting frequency. IEC/IEEE-bus command SOUR:FREQ:STAR 100MHz
STOP FREQ	Input value of the stop frequency. IEC/IEEE-bus command SOUR:FREQ:STOP 500MHz
CENTER FREQ	Input value of the center frequency. IEC/IEEE-bus command SOUR:FREQ:CENT 300MHz
SPAN	Input value of the span. IEC/IEEE-bus command SOUR:FREQ:SPAN 100MHz
CURRENT FREQ	Indication of the current frequency value. Operating mode STEP: Input value of the frequency.
STEP LIN (LOG)	Input value of the step width. Depending on whether SPACING LIN or LOG is selected, STEP LIN or STEP LOG is displayed. IEC/IEEE-bus command SOUR:SWE:STEP:LIN 1MHz

DWELL	Input value of the dwell time per step. IEC/IEEE-bus command SOUR:SWE:DWEL 10ms
SPACING	Input value of the dwell time per step. IEC/IEEE-bus command SOUR:SWE:SPAC LIN
MODE	Selection of the sweep operating mode. IEC/IEEE-bus commands SOUR:FREQ:MODE SWE; SOUR:SWE:MODE AUTO; :TRIG:SOUR SING
EXECUTE SINGLE SWEEP ►	Starts a single sweep run. This action to be executed is only indicated and is only effective if MODE SINGLE has been selected. IEC/IEEE-bus command :TRIG
RESET SWEEP ►	Sets the starting frequency. IEC/IEEE-bus command :ABOR
MARKER 1 FREQ MARKER 2 FREQ MARKER 3 FREQ	Input value of the frequency for the marker selected IEC/IEEE-bus command SOUR:MARK1:FREQ 100MHz
MARKER 1 STATE MARKER 2 STATE MARKER 3 STATE	Switching on/off the marker selected IEC/IEEE-bus command SOUR:MARK1 OFF
AMPLITUDE MARKER1 AMPLITUDE MARKER 2 AMPLITUDE MARKER 3	Switching on/off the amplitude marker selected OFF Input value of the frequency for the marker selected ON Amplitude marker is switched on. On reaching the mark the output level is reduced by 1 dB. IEC/IEEE-bus command SOUR:MARK1:AMPL OFF

2.19.7 LEVEL Sweep

Menu SWEEP - LEVEL offers access to settings for LEVEL sweep.

Menu selection: SWEEP - LEVEL

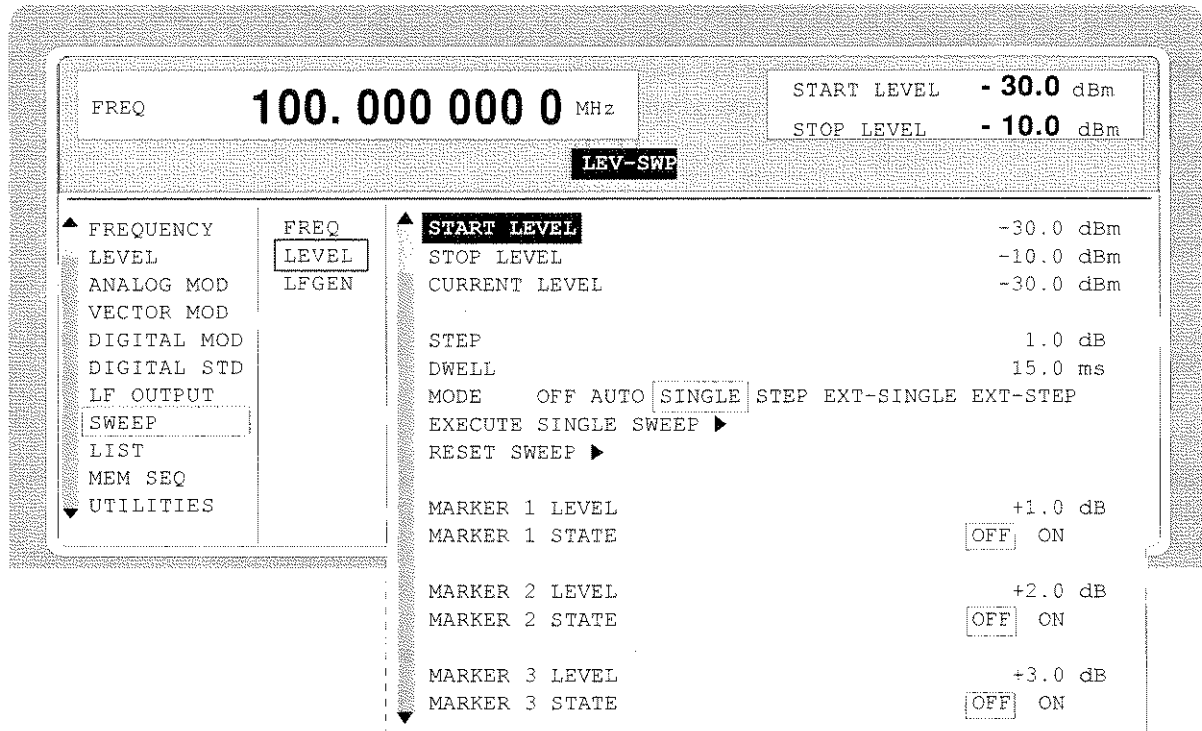

Fig. 2-127 Menu SWEEP - LEVEL

START LEVEL	Input value of the starting level. IEC/IEEE-bus command :POW:STAR -30dBm
STOP LEVEL	Input value of the stop level. IEC/IEEE-bus command SOUR:POW:STOP -10dBm
CURRENT LEVEL	Indication of the current level. Operating mode STEP: Input value of the level.
STEP	Input value of the step width. IEC/IEEE-bus command SOUR:SWE:POW:STEP 1dB
DWELL	Input value of the dwell time per step IEC/IEEE-bus command SOUR:SWE:POW:DWEL 15ms
MODE	Selection of the sweep operating mode. IEC/IEEE-bus commands SOUR:POW:MODE SWE; SOUR:SWE:POW:MODE AUTO; :TRIG:SOUR SING

EXECUTE SINGLE SWEEP ▶

Starts a single sweep run. This action to be executed is only indicated and is only effective if MODE SINGLE is selected.

IEC/IEEE-bus command : TRIG

RESET SWEEP ▶

Sets the starting level.

IEC/IEEE-bus command : ABOR

**MARKER 1 LEVEL
MARKER 2 LEVEL
MARKER 3 LEVEL**

Input value of the level for the marker selected.

IEC/IEEE-bus command SOUR:MARK1:PSW:POW 0dBm

**MARKER 1 STATE
MARKER 2 STATE
MARKER 3 STATE**

Switching on/off the marker selected.

IEC/IEEE-bus command SOUR:MARK1:PSW OFF

2.19.8 LF-Sweep

Menu SWEEP - LF GEN offers access to settings for LF sweep.

Menu selection: SWEEP - LF GEN

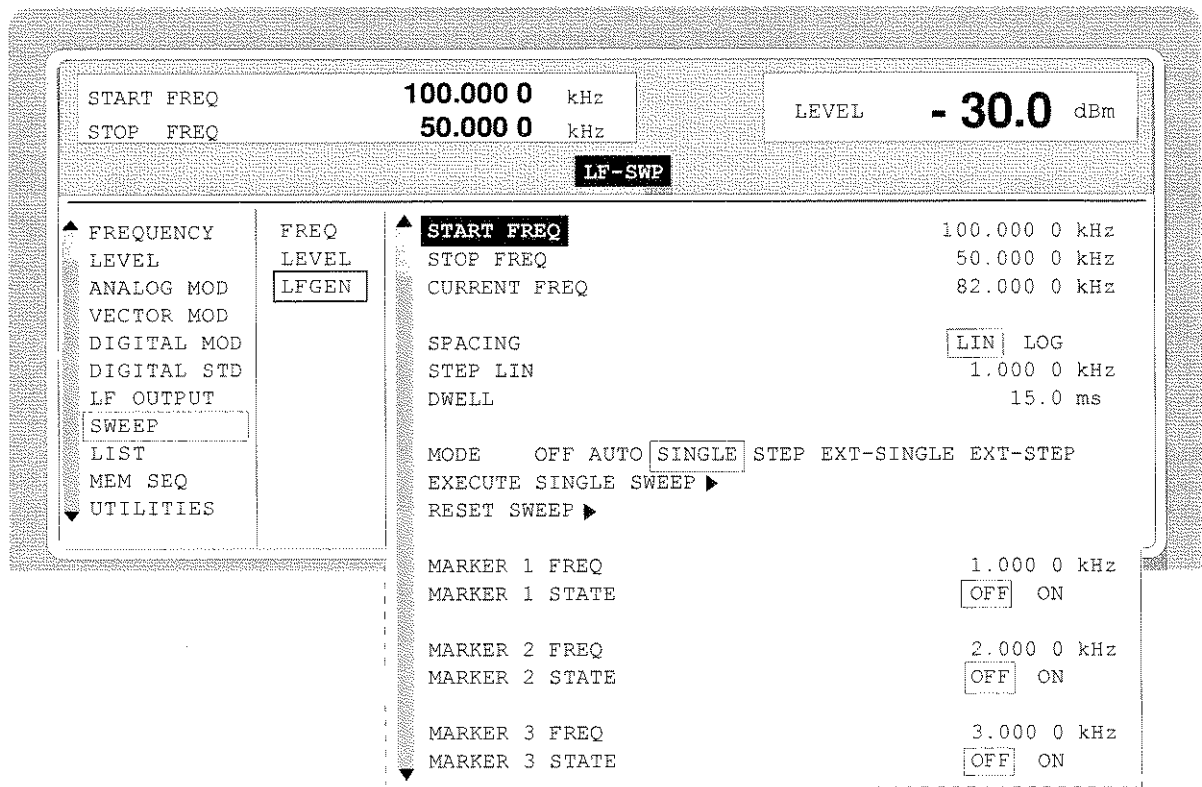

Fig. 2-128 Menu SWEEP - LF GEN

START FREQ	Input value of the starting frequency. IEC/IEEE-bus command : SOUR2:FREQ:STAR 100kHz
STOP FREQ	Input value of the stop frequency. IEC/IEEE-bus command : SOUR2:FREQ:STOP 50kHz
CURRENT FREQ	Indication of the current frequency value. Operating mode STEP: Input value of the frequency.
STEP	Input value of the step width. IEC/IEEE-bus command : SOUR2:SWE:STEP:LIN 1kHz
DWELL	Input value of the dwell time per step. IEC/IEEE-bus command : SOUR2:SWE:DWEL 15ms
SPACING	Selection of the sweep run, linear or logarithmic. IEC/IEEE-bus command : SOUR2:SWE:SPAC LIN
MODE	Selection of the sweep operating mode. IEC/IEEE-bus command : SOUR2:FREQ:MODE SWE : SOUR2:SWE:MODE AUTO : TRIG2:SOUR SING
EXECUTE SINGLE SWEEP ►	Starts a single sweep run. This action to be executed is only indicated and is only effective if MODE SINGLE is selected. IEC/IEEE-bus command : TRIG
RESET SWEEP ►	Sets the starting frequency. IEC/IEEE-bus command : ABOR
MARKER 1 FREQ MARKER 2 FREQ MARKER 3 FREQ	Input value of the frequency for the marker selected. IEC/IEEE-bus command : SOUR2:MARK1:FREQ 1kHz
MARKER 1 STATE MARKER 2 STATE MARKER 3 STATE	Switching on/off the marker selected. IEC/IEEE-bus command : SOUR2:MARK1 OFF

2.20 LIST Mode

A sequence of predefined frequency and level points is executed in the LIST mode, similar as in a sweep. Differently from the sweep, however, a list with freely selectable pairs of values (frequency and level) can be generated. The specified range of the frequency comprises the entire adjustable frequency range of the instrument. The specified range of the level covers a 20-dB range. If the permissible variation range is exceeded, the level error increases.

Caution: After the generation or change of a list in the LIST mode, function LEARN has to be started to ensure that the new settings are transferred to the hardware (IEC-bus short command: `LIST:LEAR`).

Table 2-21 LIST mode; Example of a list

Index	Frequency	Level
0001	100 MHz	0 dBm
0002	575 MHz	13 dBm
0003	235 MHz	7 dBm
0100	333 MHz	5 dBm
:	:	:

Up to 10 lists can be created. The total amount of possible pairs of values including all lists may maximally be 2000. I.e., a list may have 2000 entries at the most, or less if several lists have been created.

Each list is identified by a separate name and selected via this name. A detailed description how to process the lists can be found in Section 2.2.4, List Editor.

2.20.1 Operating Modes (MODE)

The following LIST-operating modes are available:

AUTO Run from the beginning to the end of the list with automatic restart at the beginning. If another mode was activated prior to the AUTO operating mode, continuation is made from the current index.

IEC/IEEE-bus commands: `:SOUR:FREQ:MODE LIST`
`:SOUR:LIST:MODE AUTO`
`:TRIG:LIST:SOUR AUTO`

SINGLE Single run from the beginning to the end of the list. If SINGLE is selected, the run is not yet started. Function EXECUTE SINGLE LIST ► to be executed, which can be used to start the run, is displayed below the MODE line.

IEC/IEEE-bus commands: `:SOUR:FREQ:MODE LIST`
`:SOUR:LIST:MODE AUTO`
`:TRIG:LIST:SOUR SING`

STEP	<p>Step-by-step manual processing of the list. Activating STEP stops a list running and the cursor wraps to the indication value of CURRENT INDEX. The list can now be controlled upwards or downwards in discrete steps using the rotary knob or the numeric keys.</p> <p>IEC/IEEE-bus commands: : SOUR:FREQ:MODE LIST : SOUR:LIST:MODE STEP : TRIG:LIST:SOUR SING</p>
EXT-SINGLE	<p>Single run from the beginning to the end of the list as with SINGLE, but triggered by an external trigger signal.</p> <p>IEC/IEEE-bus commands: : SOUR:FREQ:MODE LIST; : SOUR:LIST:MODE AUTO : TRIG:LIST:SOUR EXT</p>
EXT-STEP	<p>Step-by-step run by means of the external trigger signal. Each trigger event triggers a single step.</p> <p>IEC/IEEE-bus commands: : SOUR:FREQ:MODE LIST : SOUR:LIST:MODE STEP : TRIG:LIST:SOUR EXT</p>
HOP	<p>Step-by-step run by means of the internal trigger signal of the data generator (see also Section 'Internal Modulation Data and Control Signals from Lists' and Section 'Menu DIGITAL STANDARD - GSM'). Each trigger event triggers a single step.</p> <p>IEC/IEEE-bus commands: : SOUR:FREQ:MODE LIST : SOUR:LIST:MODE STEP : TRIG:LIST:SOUR HOP</p>
OFF	<p>Operating mode LIST is switched off.</p> <p>IEC/IEEE-bus command: : SOUR:FREQ:MODE CW</p>

Note: *The minimum step time of 1 ms must not be violated in modes EXT-STEP and HOP either. With fading switched on, the minimum step time is increased to 3 ms, in case of LogNormal fading it is increased to 50 ms.*

2.20.2 Inputs/Outputs

TRIGGER input and BLANK output are available at the rear of the instrument for synchronization with other instruments.

TRIGGER	<p>An external signal at this input triggers the LIST mode in operating modes EXT-SINGLE and EXT-STEP. The polarity of the active trigger edge can be set in the UTILITIES - AUX I/O - EXT TRIG SLOPE menu.</p>
BLANK	<p>This output supplies a signal (0 V/5 V) to blank the settling process by means of pulse modulation or AM. The signal can also be used to synchronize other instruments. The polarity of the signal can be set in the UTILITIES - AUX I/O - BLANK POLARITY menu.</p>

MARKER

At the first step of the LIST mode, this output provides an approx. 200 μ s trigger signal immediately after blanking. At small DWELL times, this signal can be used for an accurate synchronization to trigger other devices and shows the first stable output frequency. The delay to the fed-in signal at the TRIGGER input for EXT-SINGLE or EXT-STEP is 1.5 to 2 ms and has a jitter of 0.5 ms.

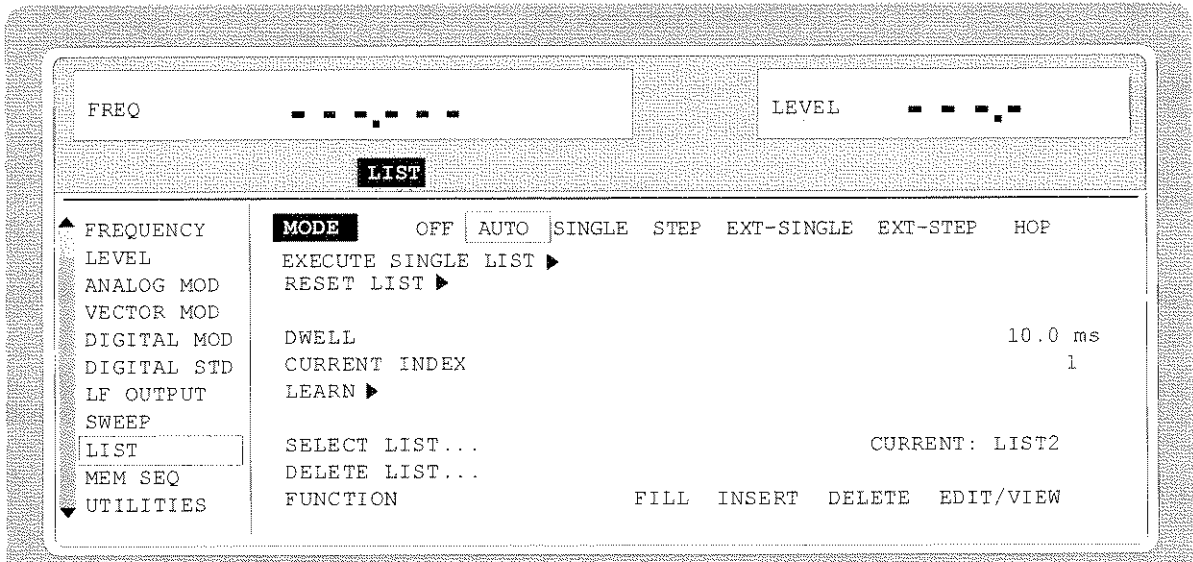

Fig. 2-129 Signal example LIST mode: MODE = EXT-STEP

The LIST menu offers access to settings for the LIST mode.

Menu selection: LIST

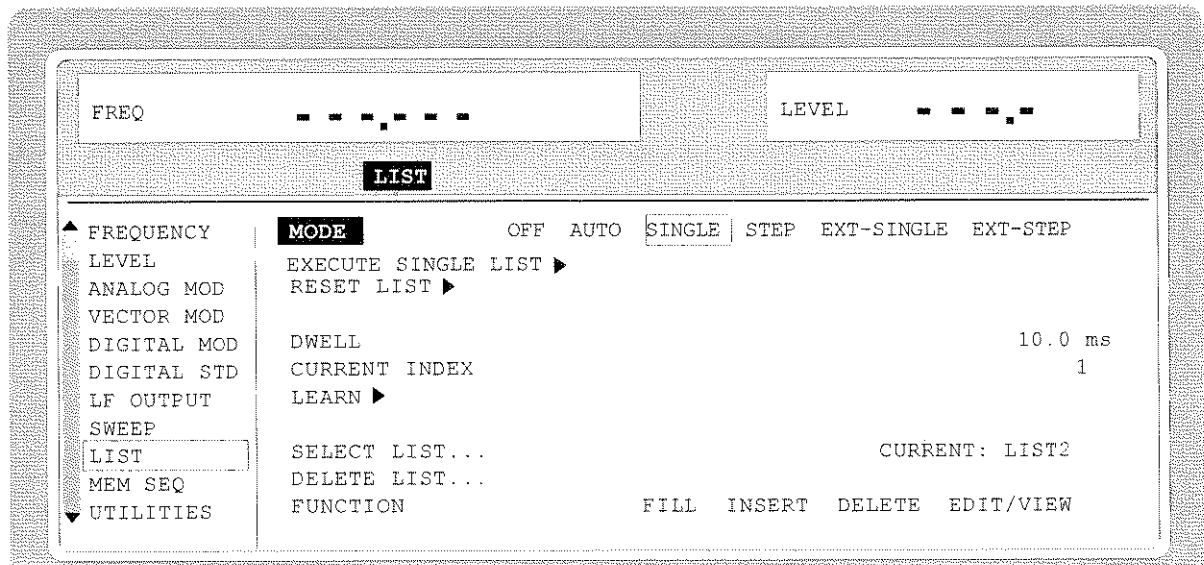

Fig. 2-130 Menu LIST - OPERATION page

MODE	Selection of the operating mode. IEC/IEEE-bus commands : :SOUR:FREQ:MODE LIST; :SOUR:LIST:MODE AUTO; :TRIG:LIST:SOUR SING
EXECUTE SINGLE LIST ►	Starts a single run of a list. This menu option is only visible if MODE SINGLE is selected. IEC/IEEE-bus command : :TRIG:LIST
RESET LIST ►	Sets the starting point. IEC/IEEE-bus command : :ABOR:LIST
DWELL	Input value of the dwell time per step. IEC/IEEE-bus command : :SOUR:LIST:DWEL 10ms
CURRENT INDEX	Indication of the current list index. Setting value of the current list index in the STEP operating mode.
LEARN ►	Starts the LEARN function. All value pairs of the active list are subsequently set by the instrument with the current additional parameters, and the hardware setting data are stored. Caution: <i>This function must be called after every creating and altering the list (or the remaining setting data). The list must be learned as well after temperature changes or after calling internal calibration routines, as all parameters usually controlled are replaced by stored values in the LIST mode.</i> IEC/IEEE-bus command : :SOUR:LIST:LEAR
SELECT LIST...	Selection of a list or creation of a new list (cf. Section 2.2.4, List Editor). IEC/IEEE-bus command : :SOUR:LIST:SEL 'LIST2'
DELETE LIST...	Deletion of a list (cf. Section 2.2.4, List Editor). IEC/IEEE-bus command : :SOUR:LIST:DEL 'LIST1'
FUNCTION	Selection of the editor functions to process a list (cf. Section 2.2.4, List Editor). IEC/IEEE : :SOUR:LIST:FREQ 100MHz, 1.2GHz; POW 0dBm, 6dBm

The second page of the LIST menu, the EDIT page is automatically activated if one of the editor functions of line FUNCTION is selected. The list which is displayed as CURRENT LIST in the SELECT LIST line is shown.

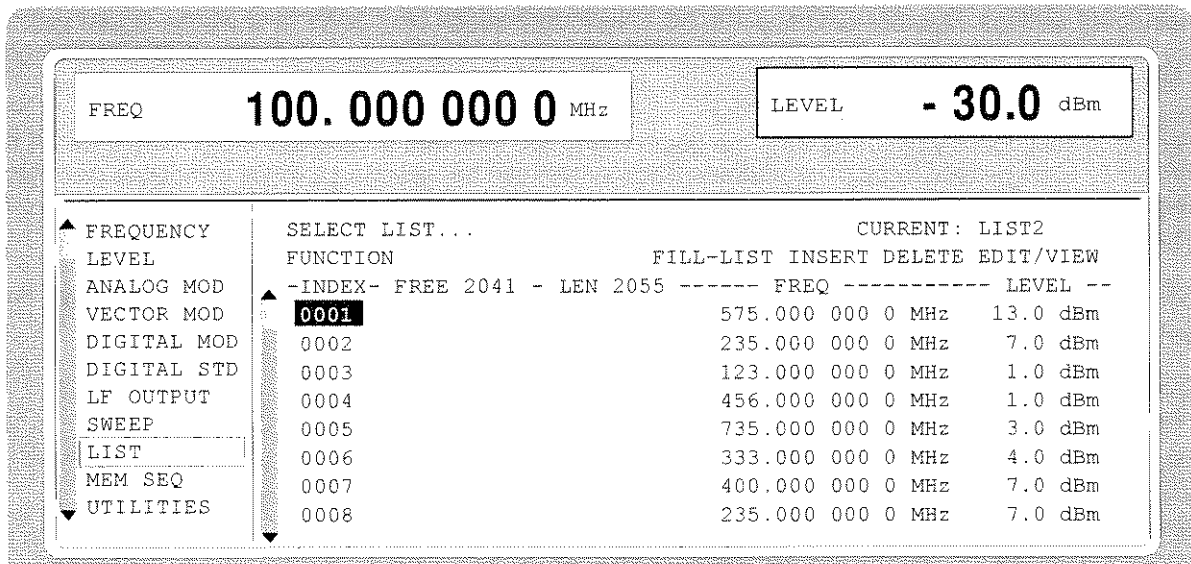

Fig. 2-131 Menu List - EDIT page

- INDEX** Index of the list.
- FREE** Indication of the list entries still vacant.
- LENGTH** Length of the current list.
- FREQ** Parameter: Frequency.
- LEVEL** Parameter: Level; specified range 20 dB.

2.21 Memory Sequence

In the memory-sequence operating mode the instrument automatically services a list with stored instrument settings. Memory locations 1 to 50, which are loaded using SAVE and whose stored settings are called either separately using RECALL or automatically and subsequently in the SEQUENCE mode, are available.

The list is continuously serviced from the beginning to the end with a continual index. The order of the memories to be passed through is arbitrary. Each setting can be assigned a freely selectable dwell time. The dwell time determines the duration of the setting, its minimal value is 50 ms, its maximal value 60 sec.

The list is divided up into 3 columns for list index, memory location number (Memory) and dwell time (Dwell).. The beginning of the list has index 1.

Table 2-22 MEMORY SEQUENCE; Example of a list

Index	Memory	Dwell
001	09	50.0 ms
002	02	50.0 ms
003	01	75.0 ms
004	10	75.0 ms
...

Up to 10 sequence lists can be created. The total number of possible list elements is maximally 256. I.e., a list can have 256 entries at the most, or less if several lists have been created.

Each list is identified by a separate name and selected via this name. A detailed description how to process the lists can be found in Section 2.2.4, List Editor.

Note: *Frequently changing the level in the operating mode MEMORY SEQUENCE can stress the mechanically switched attenuator. The attenuator is also actuated when AM is switched on or off. For this reason we recommend that you make use of the non-interrupting level setting as much as possible and that you use the setting AM 0% instead of switching AM off.*

Operating Modes (MODE)

The following operating modes are available:

- AUTO** Run from the beginning to the end of the list with automatic restart at the beginning. If another mode was activated prior to the AUTO operating mode, continuation is made from the current index.
IEC/IEEE-bus command: :SYST:MODE MSEQ;
:SYST:MSEQ:MODE AUTO
:TRIG:MSEQ:SOUR AUTO
- SINGLE** Single run from the beginning to the end of the list. If SINGLE is selected, the run is not yet started. Below the MODE line, function EXECUTE SINGLE SEQUENCE ► to be executed is displayed which can be used to start the run.
IEC/IEEE-bus command :SYST:MODE MSEQ;
:SYST:MSEQ:MODE AUTO
:TRIG:MSEQ:SOUR SING
- STEP** Step-by-step manual processing of the list. Activating STEP stops an automatic run and the cursor wraps to the indication value of CURRENT INDEX. The list can now be passed through upwards or downwards step by step using the rotary knob.
IEC/IEEE-bus command :SYST:MODE MSEQ;
:SYST:MSEQ:MODE STEP
:TRIG:MSEQ:SOUR SING
- EXT-SINGLE** Single run from the beginning to the end of the list as with SINGLE, but triggered by an external trigger signal.
IEC/IEEE-bus command :SYST:MODE MSEQ;
:SYST:MSEQ:MODE AUTO
:TRIG:MSEQ:SOUR EXT
- EXT-STEP** Step-by-step run using the external trigger signal. Each trigger event triggers a single step.
IEC/IEEE-bus command :SYST:MODE MSEQ;
:SYST:MSEQ:MODE STEP
:TRIG:MSEQ:SOUR EXT
- OFF** Step-by-step run using the external trigger signal. Each trigger event triggers a single step.
IEC/IEEE-bus command :SYST:MODE FIX

External Trigger

An external signal at the rear input TRIGGER triggers the MEMORY SEQUENCE in the EXT-SINGLE and EXT-STEP operating modes. The polarity of the active trigger edge can be set in the UTILITIES - AUX I/O - EXT TRIG SLOPE menu.

Menu MEM SEQ with the two menu pages OPERATION and EDIT offers access to the memory-sequence operating mode.

Menu selection: MEM SEQ

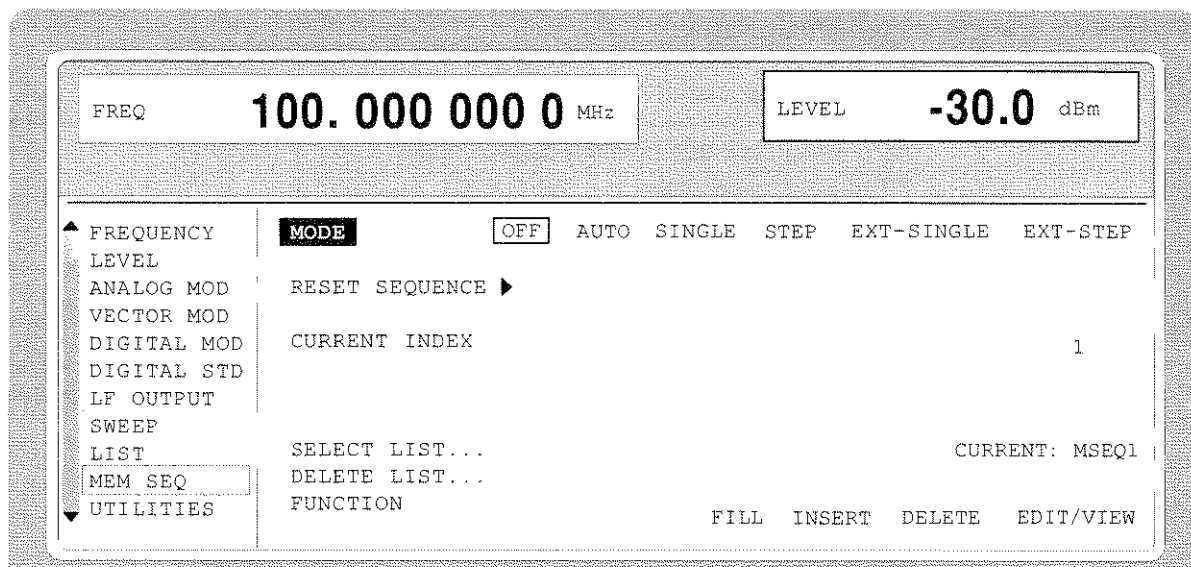

Fig. 2-132 Menu MEM SEQ -OPERATION-page (preset setting)

- MODE** Selection of the operating mode; setting the operating mode regards various command systems at the IEC bus (cf. above).

- EXECUTE SINGLE SEQUENCE ►** Starts the single run of a memory sequence. This menu option is only visible if MODE SINGLE is selected.
IEC/IEEE-bus command :TRIG:MSEQ

- RESET SEQUENCE ►** Wrap to the beginning of the list.
IEC/IEEE-bus command :ABOR:MSEQ

- CURRENT INDEX** Indication of the current list index. Setting value of the current list index in the MODE STEP operating mode.

- SELECT LIST...** Selection of a list or generation of a new list (cf. Section 2.2.4, List Editor).
IEC/IEEE-bus command :SYST:MSEQ:SEL "MSEQ1"

- DELETE LIST...** Deletion of a list (cf. Section 2.2.4, List Editor).
IEC/IEEE-bus command :SYST:MSEQ:DEL "MSEQ2"

- FUNCTION** Selection of the editor functions to process a list (cf. Section 2.2.4, List Editor).
IEC/IEEE-bus command :SYST:MSEQ 9,2,...;
:SYST:MSEQ:DWEL 50ms, 50ms, .

The second page of menu MEM SEQ, the EDIT page, is automatically activated if one of the editor functions of the FUNCTION line is selected. The list which is entered as CURRENT LIST in the SELECT LIST line is shown.

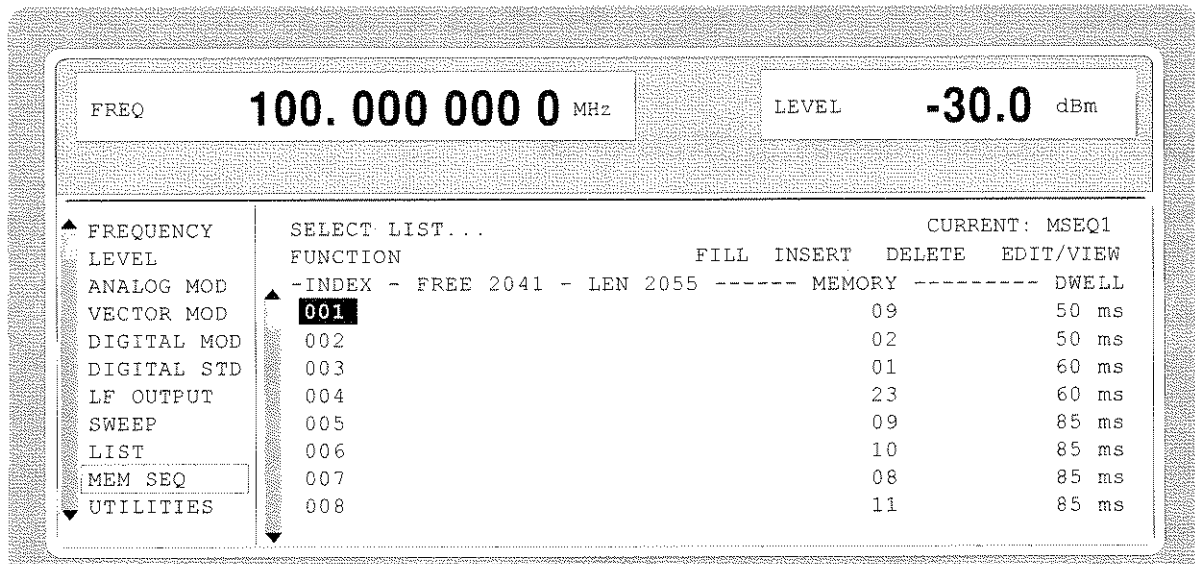

Fig. 2-133 Menu MEM SEQ - EDIT page

- INDEX** Index of the list.

- FREE** Indication of the list entries still vacant.

- LEN** Length of the current list.

- MEMORY** Parameter: number of memory location; range 1 to 50.

- DWELL** Parameter: dwell time; specified range 50 ms to 60 sec, step width 1 ms.

2.22 Utilities

The UTILITIES menu contains submenus for general functions which do not directly relate to the signal generation.

2.22.1 IEC-Bus Address (SYSTEM-GPIB)

Submenu SYSTEM-GPIB offers access to the remote-control address. The setting range is 0 to 30. At the point of delivery address 28 is set.

Menu selection: UTILITIES -SYSTEM -GPIB

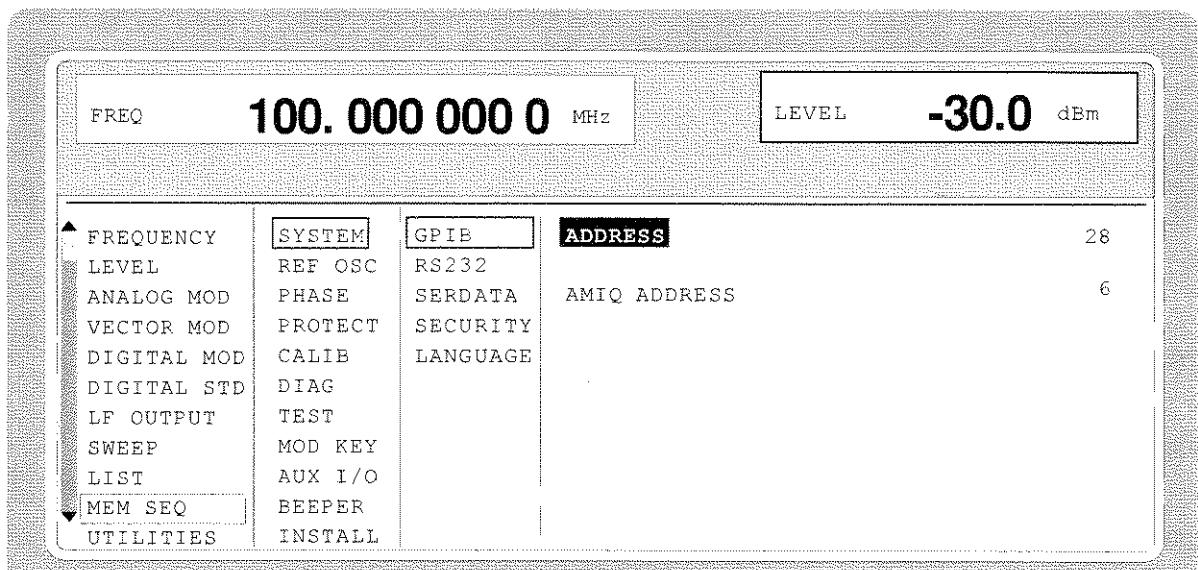

Fig. 2-134 Menu UTILITIES -SYSTEM -GPIB

ADDRESS Input value of the IEC-bus address
IEC/IEEE-bus command : SYST:COMM:GPIB:ADDR 28

AMIQ ADDRESS IEC/IEEE-bus address of AMIQ.

2.2.2.2 Parameter of the RS232 Interface (SYSTEM-RS232)

Submenu SYSTEM-RS232 offers access to the configuration of the RS-232 interface. The pin assignment of the interface corresponds to the pin assignment of a PC.

Menu selection: UTILITIES - SYSTEM - RS232

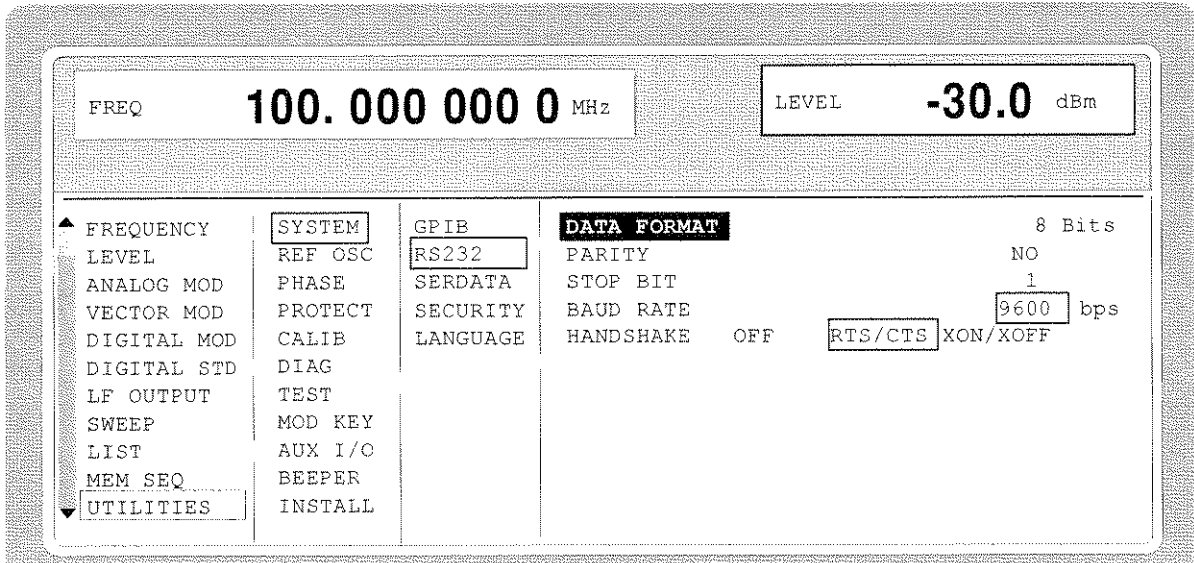

Fig. 2-135 Menu UTILITIES - SYSTEM - RS232

DATA FORMAT Indication of the number of data bits. This value cannot be changed.

PARITY Indication of parity. This value cannot be changed.

STOP BIT Indication of the number of stop bits. This value cannot be changed.

BAUD RATE Selection of the baud rate.
IEC/IEEE-bus command : SYST:COMM:SER:BAUD 9600

HANDSHAKE Selection of the handshake.

- OFF No handshake
IEC/IEEE-bus command : SYST:COMM:SER:PACE NONE
: SYST:COMM:SER:CONT:RTS ON
- RTS/CTS Hardware handshake using the interface lines RTS and CTS. This mode always is to be preferred to XON/XOFF mode, if permitted by the configuration of the host computer.
IEC/IEEE-bus command : SYST:COMM:SER:CONT:RTS RFR
- XON/XOFF Software handshake using the ASCII codes 11h <XON> and 13h <XOFF>. This mode is not recommended for binary data and for baud rates above 9600 baud.
IEC/IEEE-bus command : SYST:COMM:SER:PACE XON

2.22.3 Parameter of the SER DATA Input (SYSTEM-SERDATA)

Submenu SYSTEM-SERDATA offers access to the configuration of the SERDATA input.

Menu selection: UTILITIES - SYSTEM - SERDATA

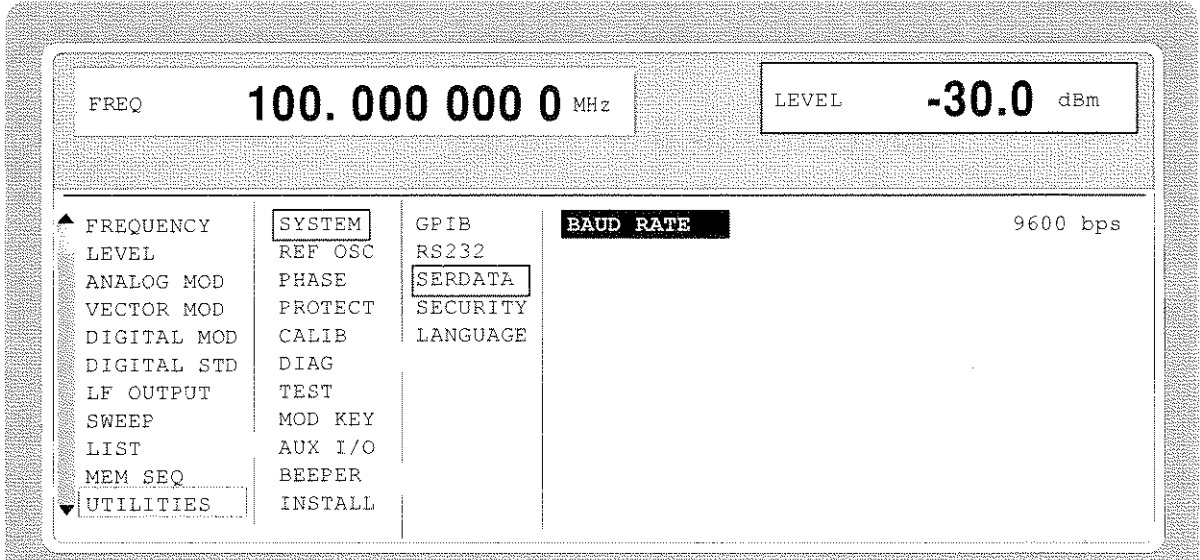

Fig. 2-136 Menu UTILITIES - SYSTEM - SERDATA

BAUD RATE

Selection of the baud rate.

IEC/IEEE-bus command : SYST:COMM:SDAT:BAUD 9600

2.22.4 Suppressing Indications and Deleting Memories (SYSTEM-SECURITY)

For security interests, indications can be suppressed and memories deleted in the SYSTEM-SECURITY submenu.

Menu selection: UTILITIES - SYSTEM-SECURITY

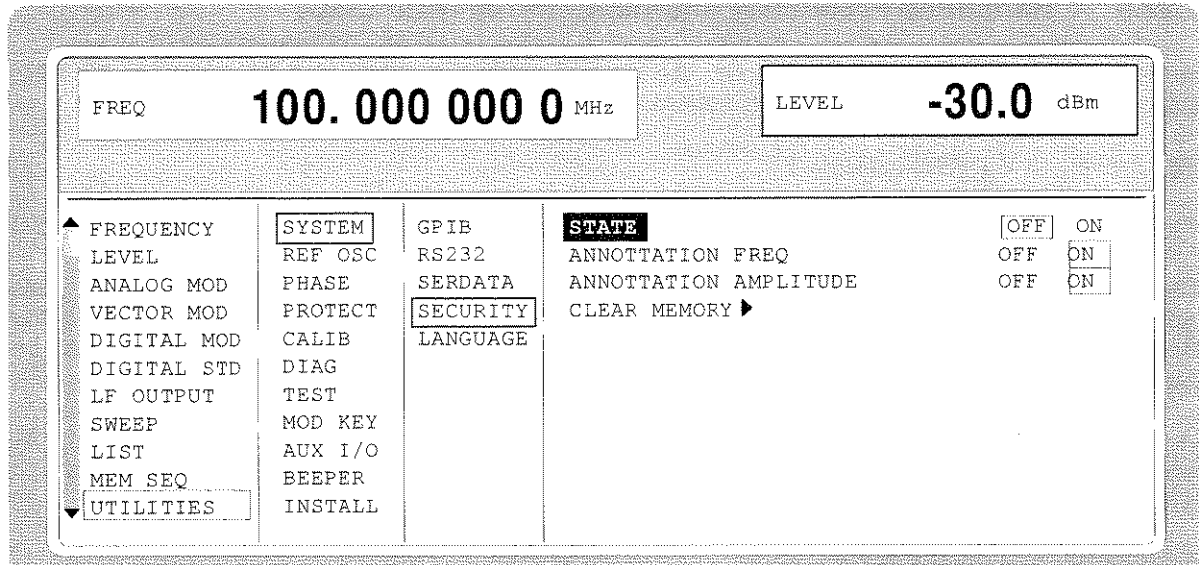

Fig. 2-137 Menu UTILITIES - SYSTEM-SECURITY

STATE

Selection of the SECURITY state

- ON Locks the suppression of the indications. Can only be set via IEC bus.
- OFF Deactivates the interlock of the indication suppression. The preset state is set in the transition ON→OFF, and all data stored such as settings, with the exception of the DM lists are deleted. Can only be set via IEC bus.

IEC/IEEE-bus command :SYST:SEC OFF

ANNOTATION FREQ

- OFF All frequency indications are suppressed.
- ON The frequency setting is displayed..

IEC/IEEE-bus command :DISP:ANN:FREQ ON

ANNOTATION AMPLITUDE

- OFF All level indications are suppressed.
- ON The level setting is displayed.

IEC/IEEE-bus command :DISP:ANN:AMPL ON

CLEAR MEMORY ▶

Deletion of all data stored such as settings, user correction and list settings stored, with the exception of the DM lists.

For this action, two commands are necessary at the IEC bus:

IEC/IEEE-bus command :SYST:SEC ON; SEC OFF

2.22.5 Indication of the IEC-Bus Language (LANGUAGE)

Submenu UTILITIES-SYSTEM LANGUAGE indicates the IEC-bus language and the current SCPI version.

2.22.6 Reference Frequency Internal/External (REF OSC)

In the internal-reference operating mode, the internal reference signal at a frequency of 10 MHz is available at the REF socket (rear of the instrument).

Signal level: $V_{\text{eff}} \text{ (EMF, sine)} = 1 \text{ V}$.

The frequency of the internal reference oscillator can be detuned via the EXT TUNE input (rear of the instrument). Input voltage range $\pm 10 \text{ V}$, pulling range $\pm 1 \times 10^{-6}$.

The external detuning is possible in both states of the ADJUSTMENT STATE (ON or OFF) unless option SM-B1, reference oscillator OCXO, is fitted. If option SM-B1, reference oscillator OCXO, is fitted, the detuning via the TUNE input is only possible if the ADJUSTMENT STATE selection has been switched to ON in the UTILITIES-REF OSC menu.

In the external-reference operating mode, an external signal at a frequency of 1 MHz to 16 MHz (spacing 1 MHz) is to be fed into socket REF. The setting to external frequency is effected in the UTILITIES-REF OSC menu.

Signal level: $V_{\text{eff}} = 0.1 \text{ to } 2 \text{ V}$

The message "EXT REF" is displayed in the status line in the header field of the display in the external-reference operating mode.

Menu selection: UTILITIES - REF OSC

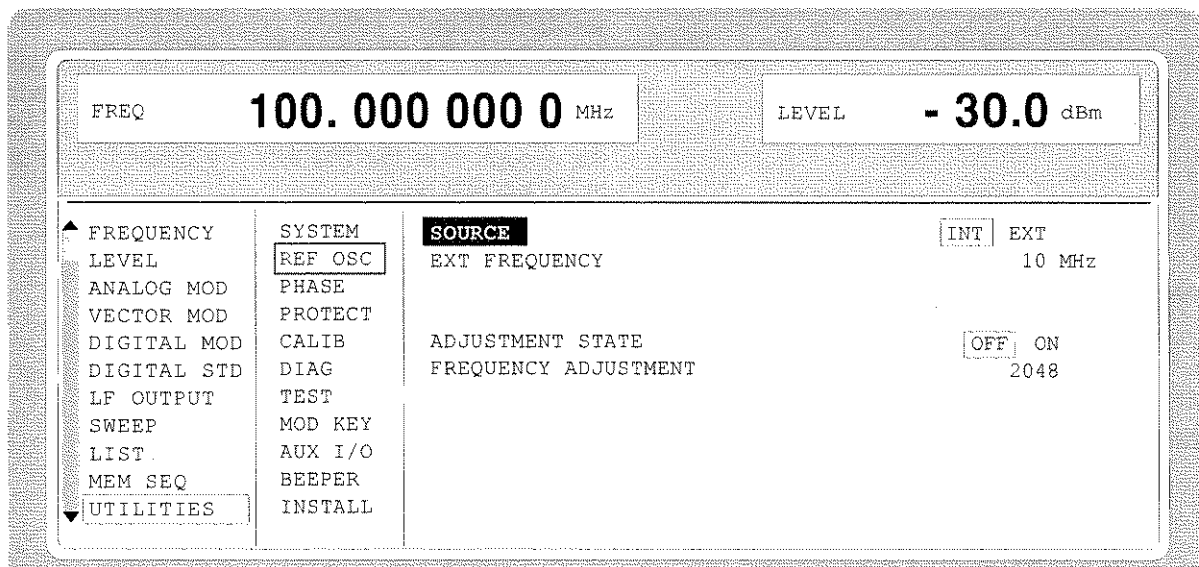

Fig. 2-138 Menu UTILITIES - REF OSC (preset setting)

SOURCE Selection of the operating mode.
 INT Internal-reference operating mode
 EXT External-reference operating mode
 IEC/IEEE-bus command SOUR:ROSC:SOUR INT

EXT FREQUENCY	Input value of the external reference frequency (1 MHz to 16 MHz, spacing 1 MHz). IEC/IEEE-bus command SOUR:ROSC:EXT:FREQ 10E6
ADJUSTMENT STATE	<p>OFF Tuning value of the internal reference frequency as calibrated (cf. menu UTILITIES-CALIB)</p> <p>ON Tuning value according to setting value FREQUENCY ADJUSTMENT. Option SM-B1, reference oscillator OCXO, is switched off. Only the standard reference oscillator is in operation.</p> <p>IEC/IEEE-bus command SOUR:ROSC:ADJ:STAT ON</p>
FREQUENCY ADJUSTMENT	Input value in the range 0 to 4095 to set the internal reference frequency. Pulling range $\pm 4 \times 10^{-6}$ IEC/IEEE-bus command SOUR:ROSC:ADJ:VAL 2048

2.22.7 Phase of the Output Signal (PHASE)

Menu UTILITIES-PHASE offers access to the phase setting of the RF output signal with respect to a reference signal of the same frequency.

Menu selection: UTILITIES - PHASE

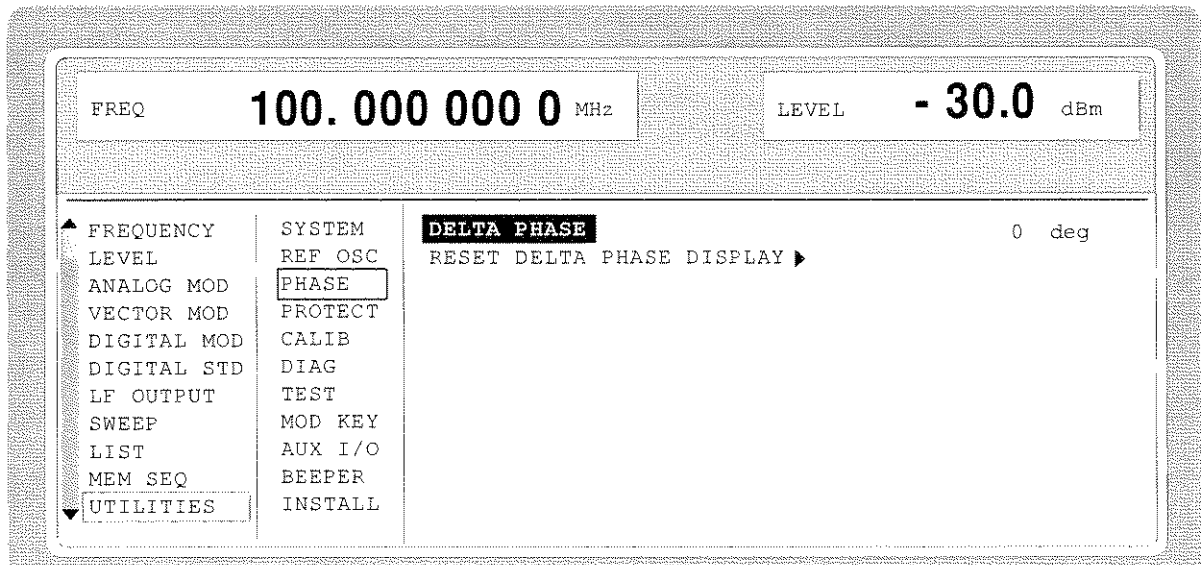

Fig. 2-139 Menu UTILITIES - PHASE (preset setting)

DELTA PHASE	Setting value of the phase. IEC/IEEE-bus command SOUR:PHAS 10 DEG
RESET DELTA PHASE DISPLAY ►	Sets the display of the DELTA PHASE to 0 without the phase of the output signal being influenced. IEC/IEEE-bus command SOUR:PHAS:REF

2.22.8 Password Input With Functions Protected (PROTECT)

The execution of calibrating and service functions is protected by a password. To unlock the lock-out, the correct password, a 6-digit number, has to be entered and then the [ENTER] key has to be pushed. After the instrument has been switched on, the lock-out is automatically activated.

Password 1 unlocks the lock-out for calibrations LEV PRESET and VCO SUM.

Password 2 unlocks the lock-out for calibration REF OSC.

Password 3 permits the input of the serial number and the value of the counter for POWER ON, operating hours and attenuator circuits.

Menu UTILITIES-PROTECT offers access to the unlocking of protected functions.

Menu selection: UTILITIES - PROTECT

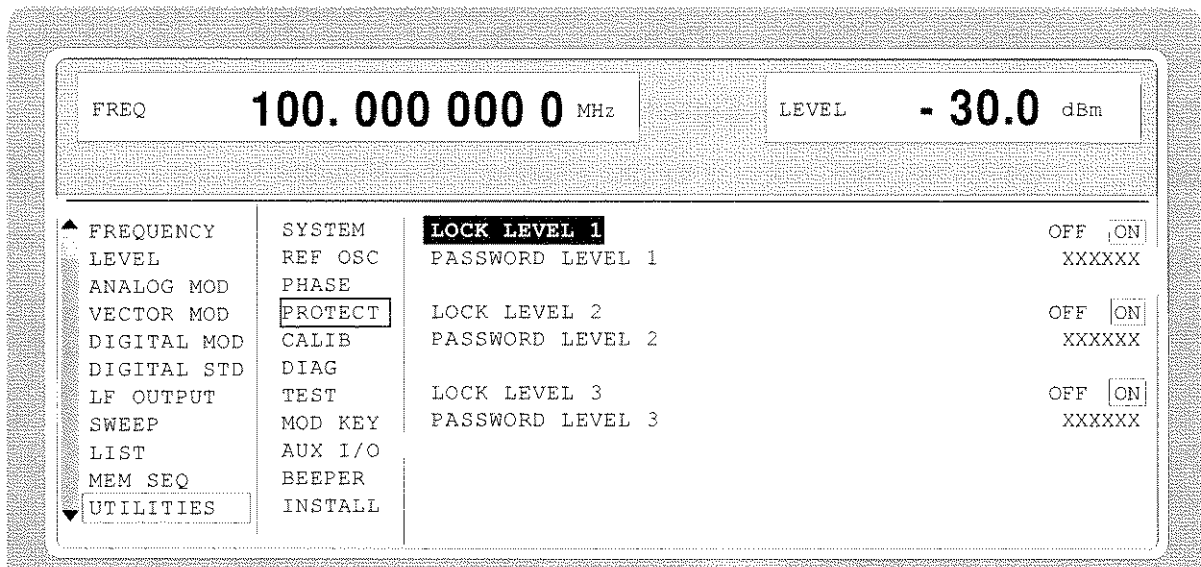

Fig. 2-140 Menu UTILITIES - PROTECT (preset setting)

LOCK LEVEL x

Activating/deactivating the lock-out.

ON The lock-out is activated.

OFF The cursor automatically wraps to the input of the password. After the password has been entered, the lock-out is deactivated.

IEC/IEEE-bus command :SYST:PROT1 ON

PASSWORD LEVEL x

Input of the password; termination with [ENTER] key.

IEC/IEEE-bus command :SYST:PROT1 OFF, 123456

2.22.9 Calibration (CALIB)

For servicing, the following menus offer access to calibrating routines and correction values:

```
UTILITIES - CALIB -  ALL
                    VCO SUM
                    VECTOR MOD
                    LEV PRESET
                    REF OSC   (cf. service manual)
                    LEVEL     (cf. service manual)
                    ALC TABLE
                    LEV ATT
                    FADING SIM
```

Internal calibration routines LEV PRESET and VCO SUM are protected by a password. They can only be executed if the lock-out in the UTILITIES - PROTECT menu has been unlocked. The password is PASSWORD LEVEL 1 = "123456".

Caution: Execute calibration routines only when the instrument has warmed up

Calibration routines LEVEL and REF OSC are described in the service manual (stock no.: 1085.2445.24).

Calibration ALL

CALIBRATION ALL triggers all internal calibrations which do not require any external measuring equipment. The calibrations with external measurements are described in the service manual.

Menu selection: UTILITIES - CALIB - ALL

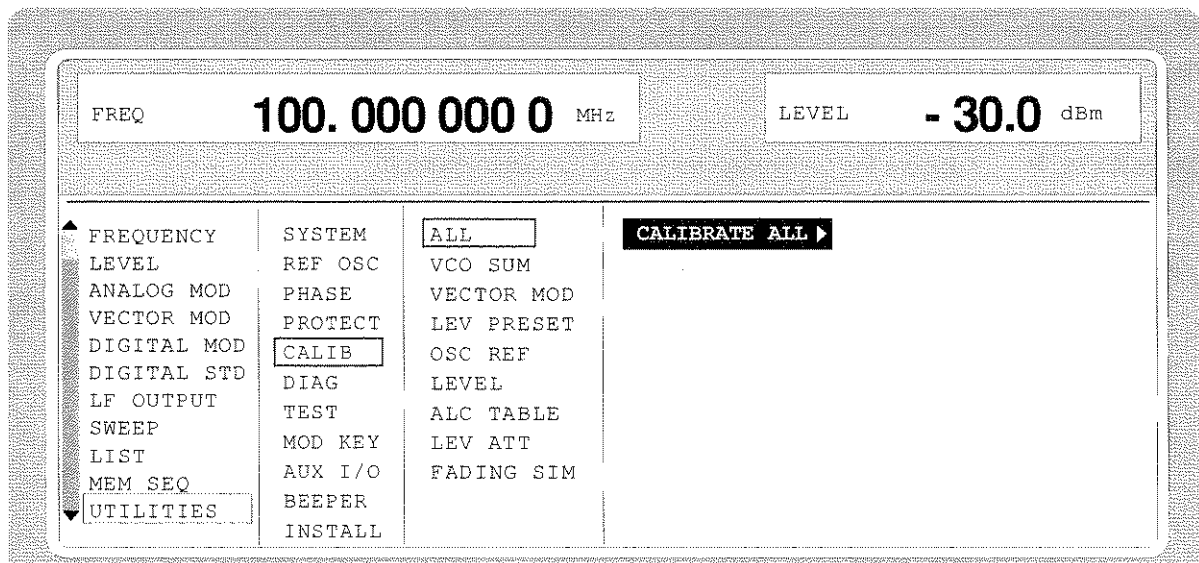

Fig. 2-141 Menu UTILITIES - CALIB - ALL

CALIBRATE ALL ▶ Triggers all internal calibrations.
IEC\IEEE-bus command :CAL:ALL?

Calibration VCO SUM

To synchronize the summing loop, the frequency the oscillator generates must be so close to the rated frequency that the phase control can lock in. This is effected by means of presetting values. The presetting values are stored in a table and can be renewed using internal calibration routine VCO SUM. The calibration routine needs only be executed after a data loss in the RAM or after an exchange of modules.

Function: In a 10-MHz division scale, the VCOs are synchronized with the rated frequency and the presetting voltage readjusted until the difference to the tuning voltage becomes minimal. The value hence achieved is entered into the table.

Menu selection: UTILITIES - CALIB - VCO SUM

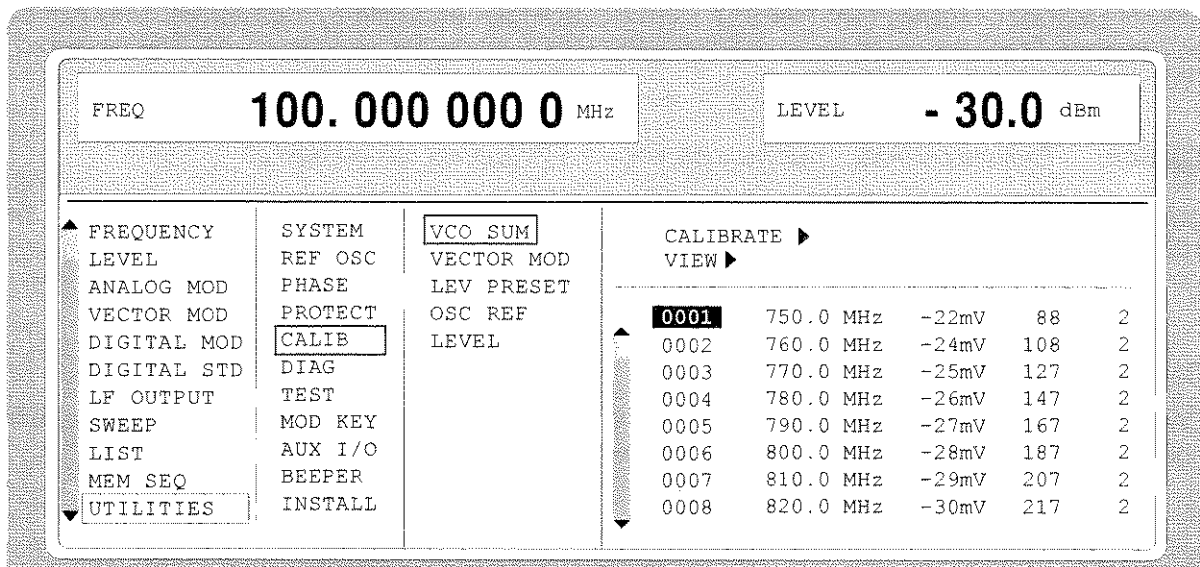

Fig. 2-142 Menu UTILITIES - CALIB - VCO SUM

CALIBRATE ► Triggers the calibration for the VCO summing loop.
IEC/IEEE-bus command :CAL:VSUM?

VIEW ► Indication of the list of correction values.
The cursor wraps to index 1 of the list. The list can be executed using the rotary knob. This index can be obtained by entering the index value on the digit block.
IEC/IEEE-bus command :CAL:VSUM:OFFS?
:CAL:VSUM:DAC?
:CAL:VSUM:KOS?

VECTOR MOD calibration

In order to obtain accurate and reproducible measurements, the I/Q modulator has to be calibrated. . To do this the internal calibration routine VECTOR MOD is used for adjusting the residual carrier, I/Q imbalance and quadrature offset of the modulator. Calibration should be carried out prior to the measurement but after a warm-up time of approx. 1 h or in the case of temperature changes of more than 5° C.

Function: By applying an internal reference voltage to the I or Q input, the modulator is driven with a defined signal which can be measured with a detector at the modulator output. D/A converters allow residual carrier, IQ imbalance and quadrature offset to be adjusted to nominal values. Calibration values are entered in a table and stored in a RAM. During the calibration a progressing bar is displayed

Menu selection: UTILITIES - CALIB - VECTOR MOD

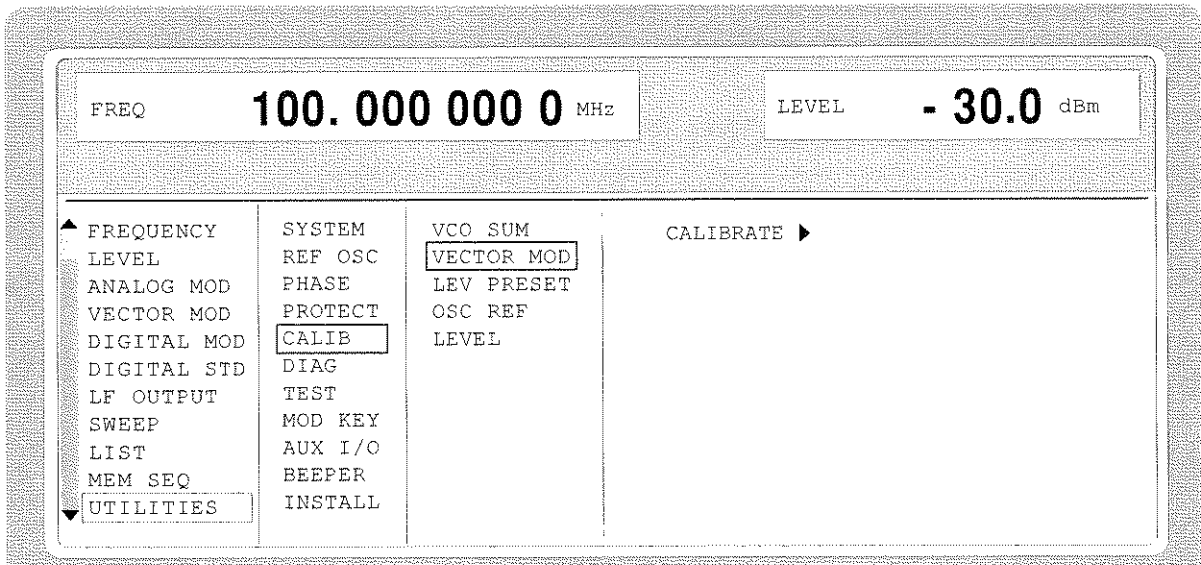

Fig. 2-143 Menu UTILITIES - CALIB - VECTOR MOD menu

CALIBRATE ► Triggers a calibration for the I/Q modulator
IEC/IEEE-bus command : CAL:VMOD?

Calibration LEV PRESET

In order to hold the amplitude modulator in the optimal working point with all frequency and level settings, a second control element is mounted by means of which the level before the modulator is set in such a way that the modulator always works in the best part of its characteristic. The setting values for the second control element are stored in a table and can be renewed using internal calibration routine LEV PRESET. The calibration routine needs only be executed in the case of a data loss in the RAM or after an exchange of modules.

Function: By alternately adjusting the two level control elements, the calibration routine determines the value for the presetting in which the amplitude modulator is operated at the attenuation demanded. The calibration is executed according to a given frequency table at levels of 10 dBm, 13dBm and 16 dBm.

Menu selection: UTILITIES - CALIB - LEV PRESET

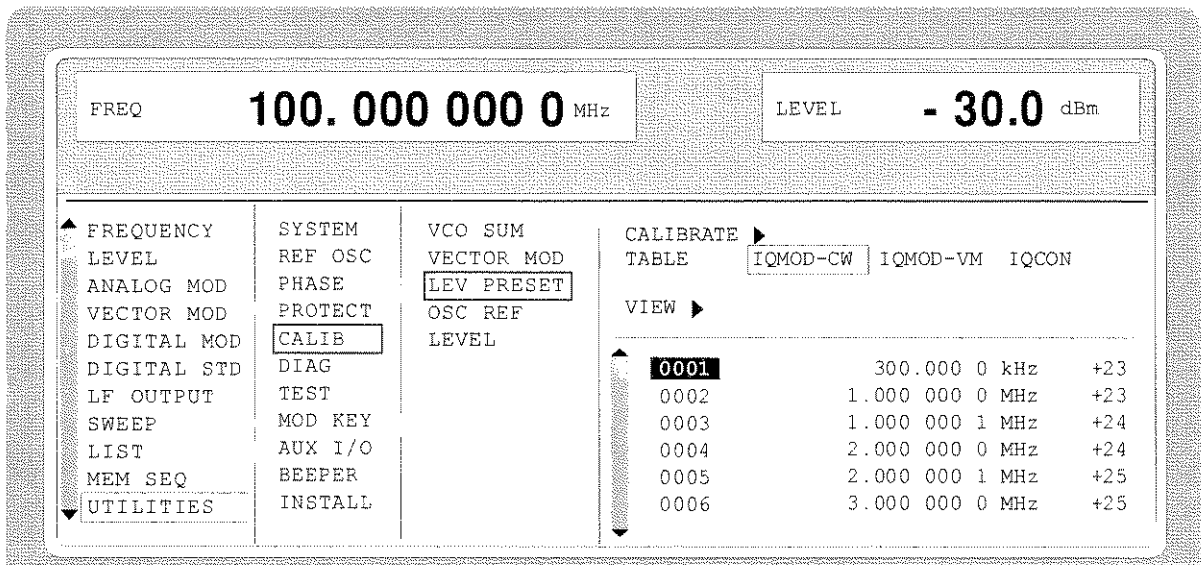

Fig. 2-144 Menu UTILITIES - CALIB - LEV PRESET

CALIBRATE ► Triggers the calibration for level preset.
IEC/IEEE-bus command :CAL:LPR?

The following parameters are only necessary for the indication of the correction values:

- TABLE** Selection of the correction values displayed by VIEW
 - IQMOD-CW Correction values of module "IQ-Modulator", valid with CW mode
 - IQMOD-VM Correction values of module "IQ-Modulator", valid with IQ mode
 - CONVERTER Correction values of module "IQ-Converter"

VIEW ► The cursor wraps to index 1 of the list. The list can be executed using the rotary knob. This index can be directly obtained by entering the index value on the digit block.
IEC/IEEE-bus command :CAL:LPR:DATA?

Calibration ALC TABLE

For vector modulation or digital modulation, SMIQ is operated with the internal level control switched off. In mode ALC MODE - SAMPLE & HOLD, the level is recalibrated for each level or frequency setting. In mode TABLE, the latter does not apply since the necessary input values are taken from a table. This table can be regenerated using LEARN TABLE ►. This is required to attain an optimum level accuracy for the given operating temperature.

Menu selection: UTILITIES - CALIB - ALC TABLE

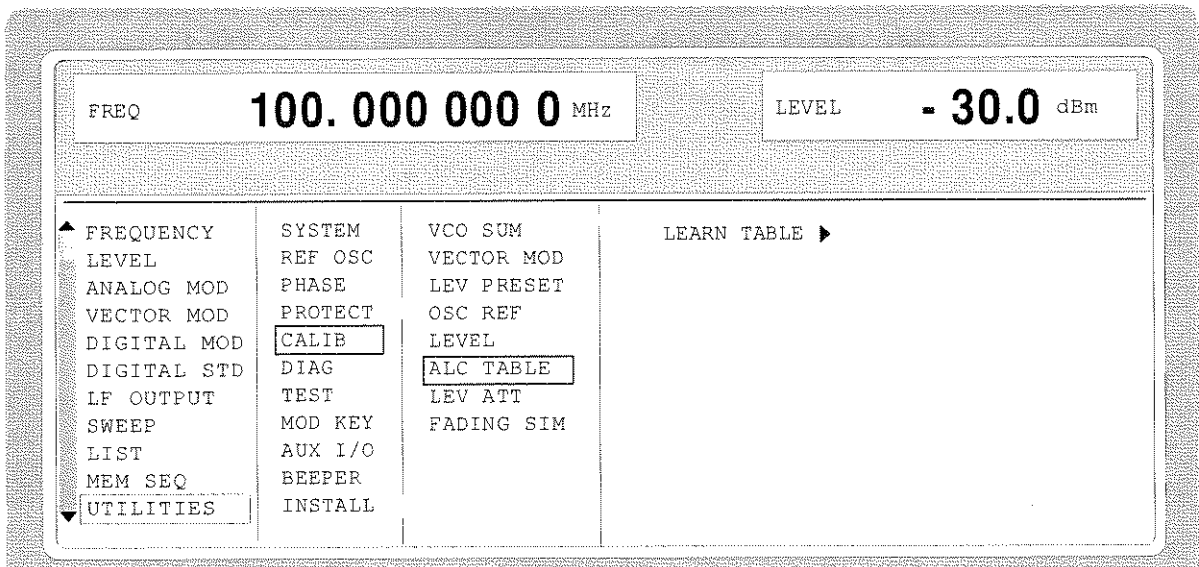

Fig. 2-145 Menu UTILITIES - CALIB - ALC TABLE

LEARN TABLE ► Triggers the generation of the new correction value for the function LEVEL-ALC-ALC OFF MODE TABLE.
 IEC/IEEE-bus command : SOUR:POW:ALC:TABL?

Calibration LEV ATT

For digital modulation (DIGITAL MOD and DIG STANDARD) and with the function LEV ATT switched on, the output level of SMIQ is reduced by a settable value in dB for a certain time (eg a slot). Calibration serves for attaining an optimum accuracy of level reduction.

Menu selection: UTILITIES - CALIB - LEV ATT

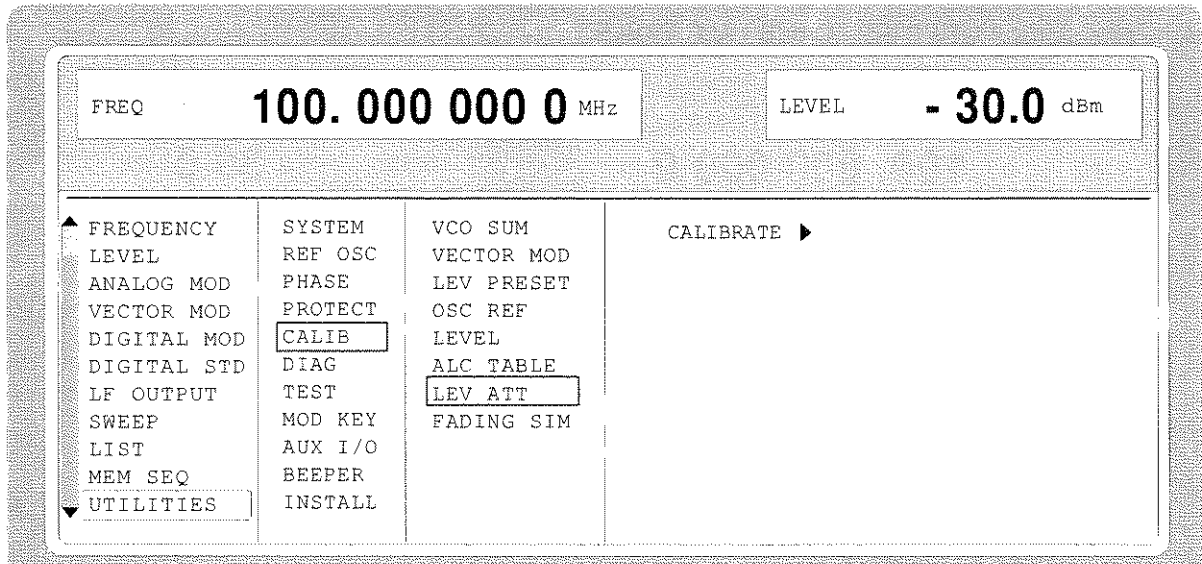

Fig. 2-146 Menu UTILITIES - CALIB - LEV ATT

CALIBRATE ▶ Triggers the calibration for the function LEV ATT.
 IEC/IEEE-bus command :CAL:LATT?

FADING SIM calibration

Unwanted spectral lines of the carrier frequency and Doppler frequency are caused by the offset voltages of A/D and D/A converters in the fading simulator. These offset voltages can be automatically compensated by calling up a self-calibration. Calibration should be carried out prior to the measurement but after a warm-up time of approx. 1 h or in the case of temperature changes of more than 5° C.

Menu selection: UTILITIES - CALIB - FADING SIM

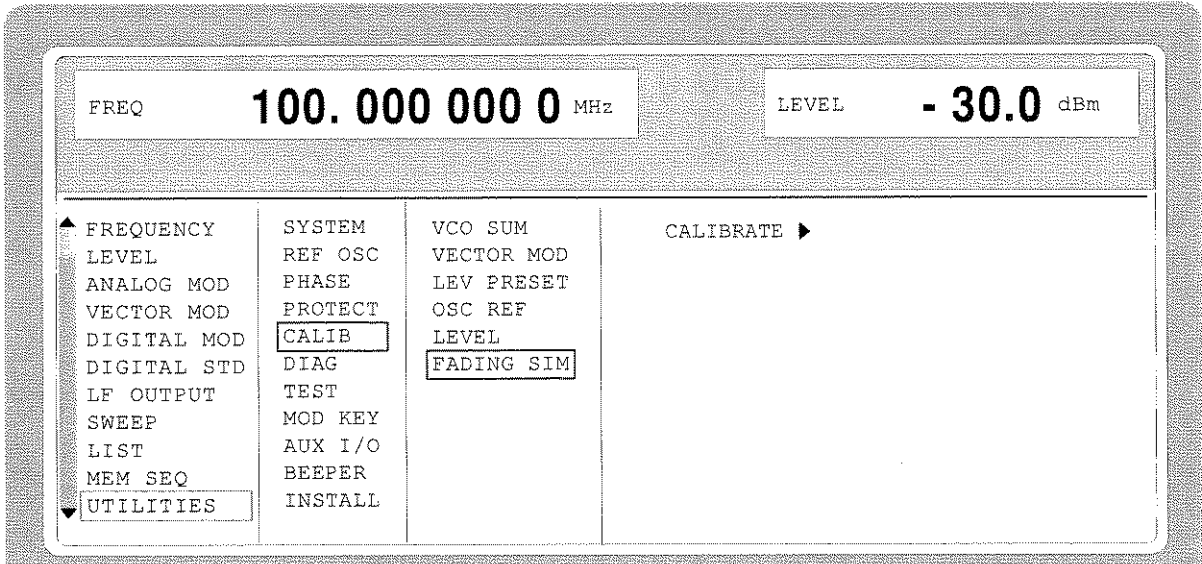

Fig. 2-147 Menu UTILITIES - CALIB - FADING SIM, fitted with option SMIQB14, Fading Simulator

CALIBRATE ▶ Triggers the calibration of the fading simulator
 IEC/IEEE-bus command :CAL:FSIM?

2.22.10 Indications of Module Variants (DIAG-CONFIG)

For service purposes, the modules installed can be indicated with their variants and states of modification. Submenu DIAG-CONFIG offers access to the module indication.

IEC/IEEE-bus command :DIAG:INFO:MOD?

Menu selection: UTILITIES - DIAG - CONFIG

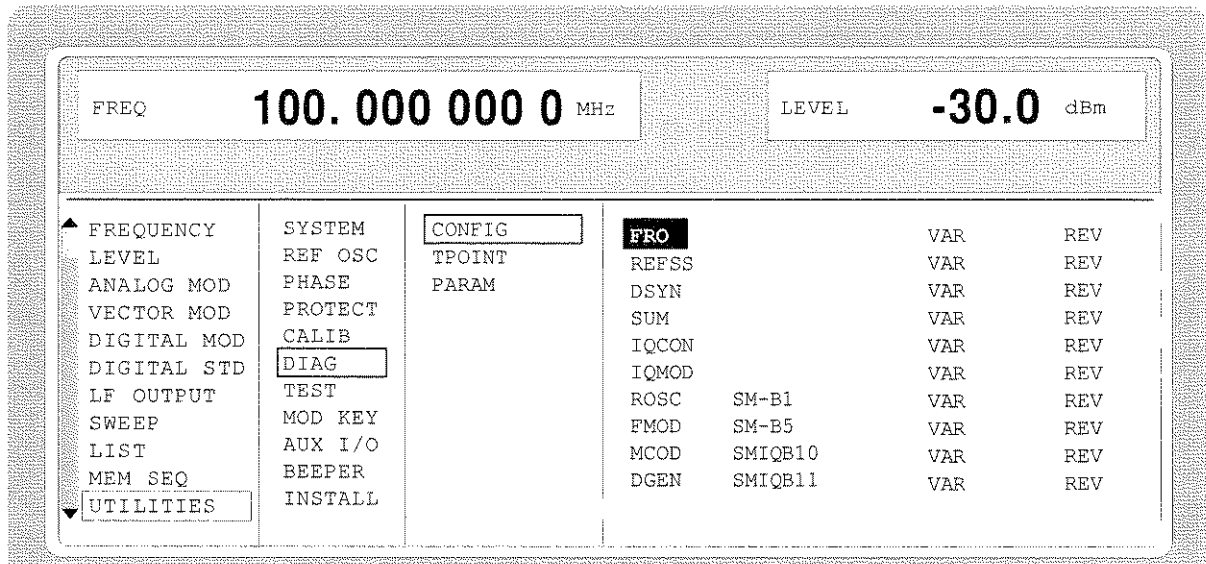

Fig. 2-148 Menu UTILITIES - DIAG - CONFIG

2.22.11 Voltage Indication of Test Points (DIAG-TPOINT)

Submenu DIAG-TPOINT offers access to internal test points. If a test point is switched on, the voltage indication is displayed in a window in the header field. For greater detail, see service manual.

Menu selection: UTILITIES - DIAG - TPOINT

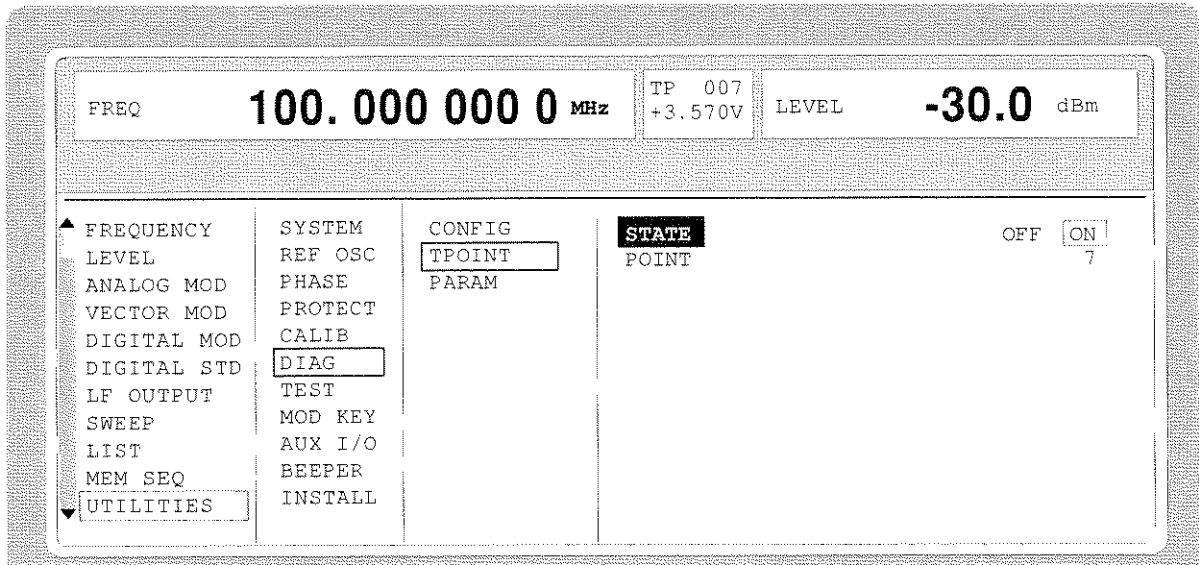

Fig. 2-149 Menu UTILITIES - DIAG - TPOINT

STATE Switching on/off the voltage indication in the header field.

POINT..... Input value of the test point.
 IEC/IEEE-bus command :DIAG:POINxx?

2.22.12 Indications of Service Data (DIAG-PARAM)

Submenu DIAG-PARAMETER offers access to different parameters such as serial number, software version, operating-hours counter and attenuator circuits.

Menu selection: UTILITIES - DIAG - PARAM

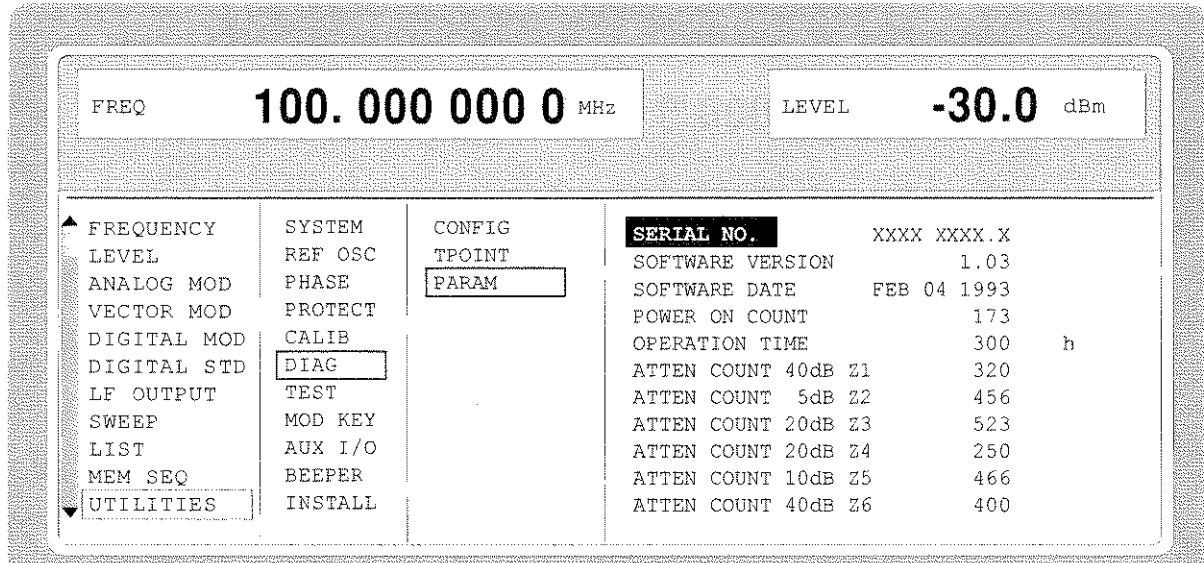

Fig. 2-150 Menu UTILITIES - DIAG - PARAM

For IEC-bus commands, cf. Chapter 3, Section "DIAGnostic System".

2.22.13 Test (TEST)

(cf. Chapter 4, Section "Functional Test")

2.22.14 Assigning Modulations to the [MOD ON/OFF] Key (MOD-KEY)

The modulations can be switched on/off in the individual modulation menus and parallelly by means of the [MOD ON/OFF] key.

For which modulations the [MOD ON/OFF] key is effective can be defined in the UTILITIES-MOD KEY menu. The key can either be effective for all modulations or for a selected one.

Function of the [MOD ON/OFF] key if effective for a type of modulation:

- Every pressing a key alters the state (ON or OFF) of the selected modulation.

Function of the [MOD ON/OFF] key if effective for all types of modulation (ALL):

- If at least one modulation is switched on, pressing the [MOD ON/OFF] key switches the modulation/s off. Which modulations were switched on is stored.

If no modulation is switched on, pressing the [MOD ON/OFF] key switches on the modulations which were last switched off using the [MOD ON/OFF] key.

On switching on using the [MOD ON/OFF] key, the modulation sources are used as defined in the modulation menus.

Access to the selection of the modulation to be switched using the [MOD ON/OFF] key is possible in the UTILITIES-MOD KEY menu.

Menu selection: UTILITIES - MOD KEY

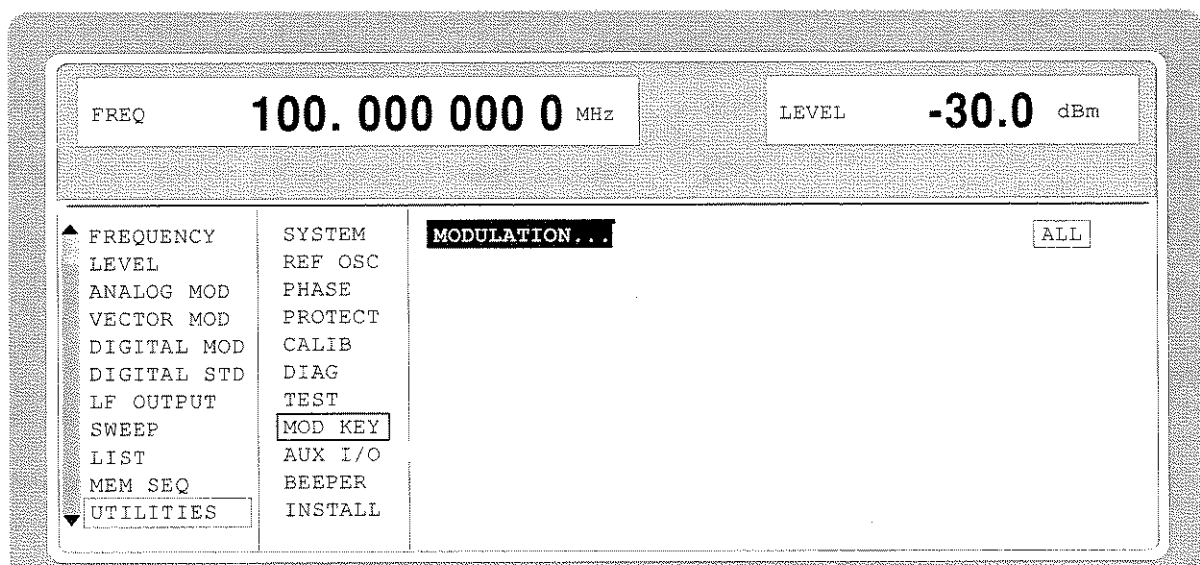

Fig. 2-151 Menu UTILITIES - MOD KEY (preset setting)

MODULATION

Open a window for selection of the modulation for which the [MOD ON/OFF] key is to be effective. The following is to choose from:
ALL, AM, BB-AM, FM, PM, DM, VM, FSIM.

Note: Preset switches off all modulations, sets the selection to ALL and stores AM 30%, AM SOURCE INT as default setting.

2.22.15 Setting Auxiliary Inputs/Outputs (AUX-I / O)

Menu UTILITIES - AUX I/O offers access to settings for the TRIGGER input, BLANK output and MARKER output. Sections Sweep and Memory Sequence provide further information.

Menu selection: UTILITIES - AUX I/O

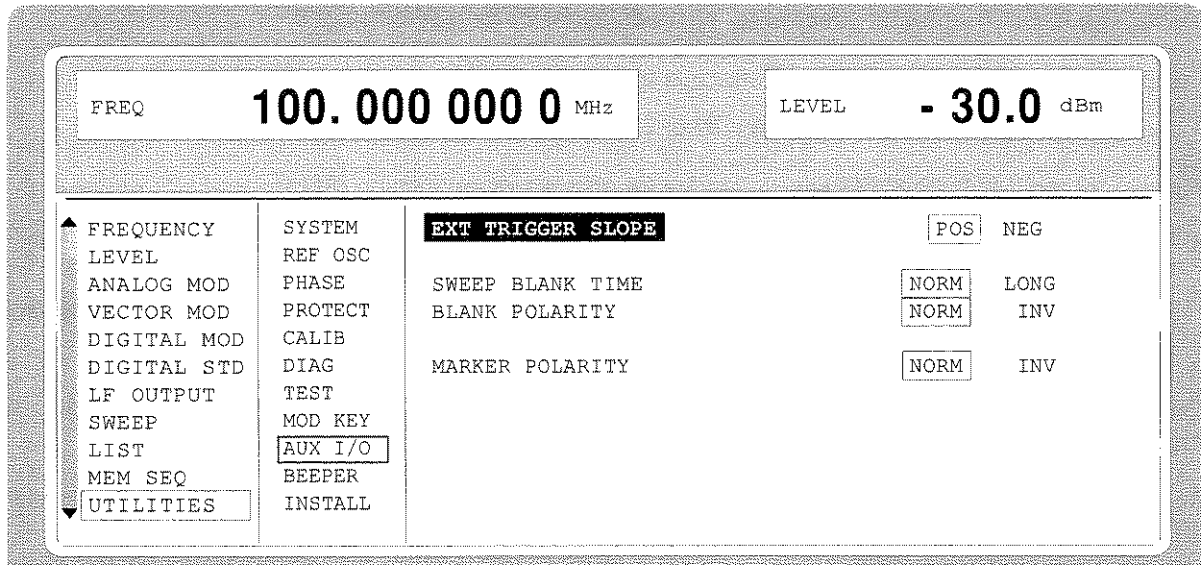

Fig. 2-152 Menu UTILITIES - AUX I/O

EXT TRIGGER SLOPE

Selection of the active edge of the external trigger signal.

POS The instrument triggers on the positive edge of the external signal.

NEG The instrument triggers on the negative edge of the external signal.

EITHER The instrument triggers on both edges of the external signal.

IEC/IEEE-bus command :TRIG:SLOP POS

SWEEP BLANK TIME

Selection of the blank duration.

NORM BLANK duration is set to the shortest duration possible.

LONG The BLANK duration is set for the PEN LIFT control of an XY recorder (approx. 500ms).

IEC/IEEE-bus command :SOUR2:SWE:BTIM NORM

BLANK POLARITY

Selection of the polarity for the blank signal.

NORM With active BLANK, the output signal is HIGH.

INV Polarity is inverted.

IEC/IEEE-bus command :OUTP:BLAN NORM

MARKER POLARITY

Selection of the polarity for the marker signal.

NORM The output signal is HIGH when the sweep cycle reaches the mark.

INV Polarity is inverted.

IEC/IEEE-bus command SOUR:MARK:POL NORM

2.22.16 Switching On/Off Beeper (BEEPER)

Menu UTILITIES-BEEPER offers access to the switching on/off of the beeper.

Note: Preset does not alter the current state (ON or OFF).

Menu selection: UTILITIES - BEEPER

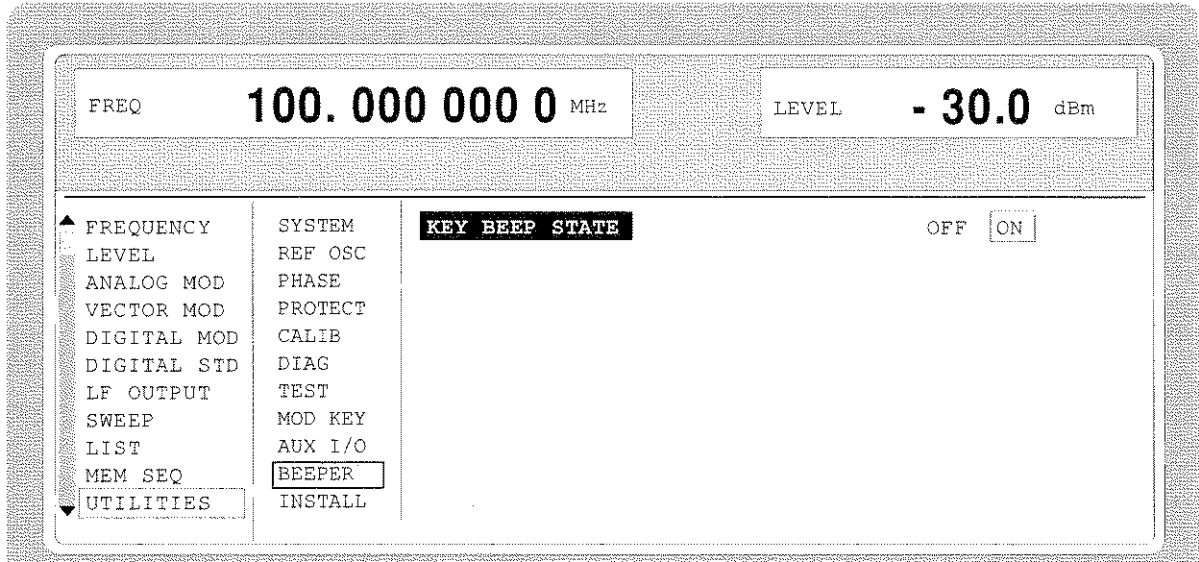

Fig. 2-153 Menu UTILITIES - BEEPER

KEY BEEP STATE Switching on/off the beeper
 IEC-bus command :SYST:BEEP:STAT ON

2.22.17 Installation of Software Option

Options are installed in the menu UTILITIES-INSTALL by means of a keyword. The keyword is part to the equipment supplied in case of a follow-up order.

Menu UTILITIES-INSTALL gives access to the keyword entry.

Menu selection: UTILITIES - INSTALL

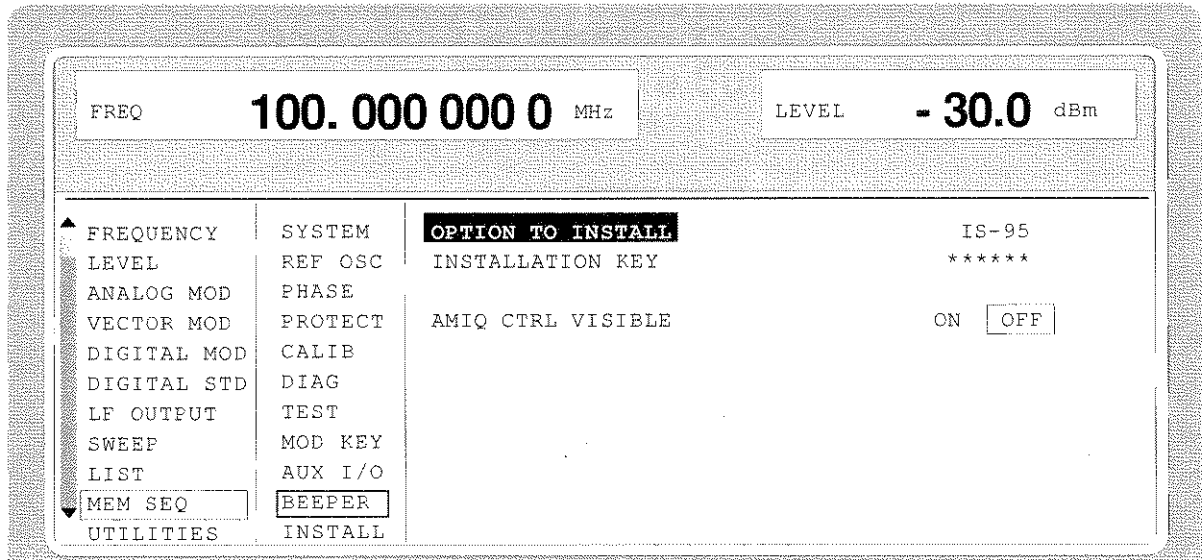

Fig. 2-154 Menu UTILITIES - INSTALL, fitted with options

OPTION TO INSTALL

Selection of the option to be installed.

INSTALLATION KEY

Entry of the keyword; after entry, press key [ENTER].

AMIQ CTRL VISIBLE

Activates or deactivates menu AMIQ CTRL.

2.23 The Help System

The SMIQ has two help systems. On the one hand the context-sensitive help which is called by means of the HELP key and which gives information on the current menu. On the other hand, auxiliary texts can be selected according to headwords in alphabetical order by accessing menu HELP.

HELP Key

The yellow HELP key can be pressed at any point in time. The current setting menu is faded out and context-sensitive text faded in. The help panel can be exited by means of the RETURN key.

Menu HELP

After calling the help menu, access to all auxiliary texts is possible via an index. Operation is analog to menu operation.

- Set the menu cursor to the index desired using the shaft encoder.
- Press the [SELECT] key.
- The information for the index marked is displayed.
- Press the [RETURN] key to exit the menu.

2.24 Status

By means of a STATUS page, the SMIQ permits an overview over all settings of the instrument. The settings are displayed in an abbreviated form. The STATUS page is called by pressing the [STATUS] key. Return to the preceding menu is effected using the [RETURN] key.

FREQ 100.000 000 0 MHz		LEVEL - 30.0 dBm	
AM		ALC-ON	
AM: INT 30.0%		LF: 1.000 0kHz	
BB-AM: OFF		LF-OUTPUT: OFF	
PULSE: OFF		SWEEP / LIST: OFF	
VM: OFF		BLANK POL: NORM; TIME: NORM	
DM: OFF		REF OSC: 10MHz INT ADJUST: OFF	
		ALC: ON	
		TRIGGER SLOPE: POS	
		LOCAL	
		UNLOCKED	

Fig. 2-155 Menu STATUS page

2.25 Error Messages

The SMIQ displays error and caution messages in a different manner, depending on how long, for a short period of time or permanently, the cause exists.

Short-term message

The short-term message is displayed in the status line. Part of it overwrites the status indications and disappears after approx. 2 seconds or in the case of a new entry.

The instrument shows, e.g., short-term messages if the attempt is made to enter an overrange or if incompatible operating modes deactivate one another.

Long-term message

The long-term message is displayed in the status line by means of the message "WARNING" or "ERROR". Pressing the [ERROR] key calls the ERROR page in which the messages are entered. Several messages can be entered at the same time. The long-term message remains existing until there is no cause any more. The ERROR page is exited using the [RETURN] key.

The instrument displays, e.g., the long-term message "ERROR" if there is a hardware error or "WARNING" if overrange settings have been made.

Notes: – An error message "ERROR" does not necessarily point to a defect instrument. There are various operating states which can cause an ERROR message. E. g. if the instrument is set to external reference but no external reference is connected.

- Error 313 indicates the loss of calibration data and is also applicable in case of a cold start (key [PRESET] is pressed during switch-on). The calibration values can be restored with internal calibration routines. These routines are accessible via menu UTILITIES-CALIB (see section on calibration).

The ERROR page offers access to long-term messages if the [ERROR] key is pressed.

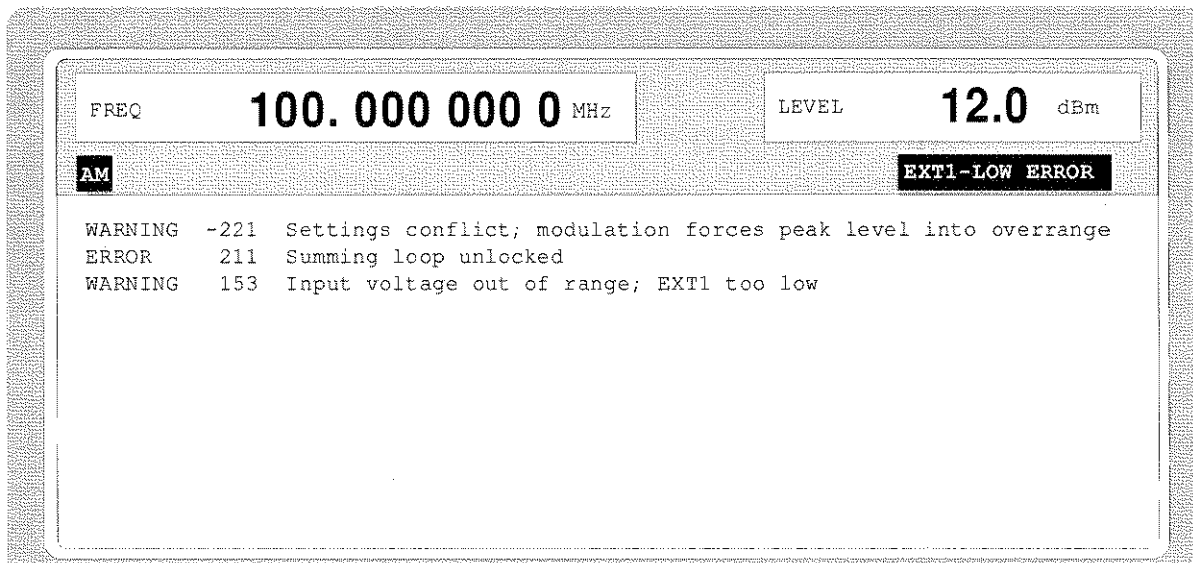

Fig. 2-156 ERROR page

A list of the possible error messages is to be found in annex B.

3 Remote Control

The instrument is equipped with an IEC-bus interface according to standard IEC 625.1/IEEE 488.2 and a RS-232 interface. The connectors are located at the rear of the instrument and permit to connect a controller for remote control. The instrument supports the SCPI version 1994.0 (Standard Commands for Programmable Instruments). The SCPI standard is based on standard IEEE 488.2 and aims at the standardization of device-specific commands, error handling and the status registers.

This section assumes basic knowledge of IEC-bus programming and operation of the controller. A description of the interface commands is to be obtained from the relevant manuals.

The requirements of the SCPI standard placed on command syntax, error handling and configuration of the status registers are explained in detail in the respective sections. Tables provide a fast overview of the commands implemented in the instrument and the bit assignment in the status registers. The tables are supplemented by a comprehensive description of every command and the status registers. Detailed program examples of the main functions are to be found in annex D. The program examples for IEC-bus programming are all written in QuickBASIC.

Note: *In contrast to manual control, which is intended for maximum possible operating convenience, the priority of remote control is the predictability of the device status. This means that when incompatible settings (e.g. activation of PM and FM at the same time) are attempted, the command is ignored and the device status remains unchanged, i.e. is not adapted to other settings. Therefore, IEC/IEEE-bus control programs should always define an initial device status (e.g. with command *RST) and then implement the required settings.*

3.1 Brief Instructions

The short and simple operating sequence given below permits fast putting into operation of the instrument and setting of its basic functions.

3.1.1 IEC-Bus

It is assumed that the IEC-bus address, which is factory-set to 28 has not yet been changed.

1. Connect instrument and controller using IEC-bus cable.
2. Write and start the following program on the controller:

CALL IBFIND("DEV1", generator%)	Open port to the instrument
CALL IBPAD(generator%, 28)	Inform controller about instrument address
CALL IBWRT(generator%, "*RST;*CLS")	Reset instrument
CALL IBWRT(generator%, "FREQ 50MHz")	Set frequency to 50 MHz
CALL IBWRT(generator%, "POW -7.3dBm")	Set output level -7.3m dBm
CALL IBWRT(generator%, "AM:SOUR INT")	Set AM modulation source LFGEN
CALL IBWRT(generator%, "AM:INT:FREQ 15kHz")	Set AM modulation source LFGEN
CALL IBWRT(generator%, "AM 30PCT")	Set AM modulation depth 30%
CALL IBWRT(generator%, "AM:STAT ON")	Switch on AM

An amplitude-modulated signal is now applied at the output of the instrument.

3. To return to manual control, press the LOCAL key at the front panel.

3.1.2 RS-232 Interface

It is assumed that the configuration of the RS-232 interface at the unit has not yet been changed.

1. Connect unit and controller using the 0-modem cable.
2. Enter the following command at the controller to configure the controller interface:
mode com1: 9600, n, 8, 1
3. Create the following ASCII file:

```
*RST; *CLS
FREQ 50MHz
POW -7.3dBm
OUTP:STAT ON
AM:SOUR INT
AM:INT:FREQ 15kHz
AM 30PCT
AM:STAT ON
```

```
Switch instrument to remote control (Return key)
Reset instrument
Set frequency 50 MHz
Set output level -7.3 dBm
Switch on RF output
Set AM modulation source LFGEN
Set modulation frequency 15 kHz
Set AM modulation depth 30%
Switch on AM
(Return key)
```

4. Transfer ASCII file to unit via RS-232 interface. Enter the following command at the controller:
copy <filename> com1:
An amplitude-modulated signal is now applied at the output of the instrument.
5. To return to manual control, press the [LOCAL] key at the front panel.

3.2 Switchover to Remote Control

On power-on, the instrument is always in the manual operating state ("LOCAL" state) and can be operated via the front panel.

The instrument is switched to remote control ("REMOTE" state)

IEC-bus as soon as it receives an addressed command from a controller.

RS-232 as soon as it receives either a carriage return <CR> (=0Dh) or a line feed <LF> (0Ah) from a controller.

During remote control, operation via the front panel is disabled. The instrument remains in the remote state until it is reset to the manual state via the front panel or via IEC bus (see Sections 3.2.1.3 and 3.2.2.3). Switching from manual operation to remote control and vice versa does not affect the remaining instrument settings.

3.2.1 Remote Control via IEC Bus

3.2.1.1 Setting the Device Address

The IEC-bus address of the instrument is factory-set to 28. It can be changed manually in the UTILITIES-SYSTEM-GPIB-ADDRESS menu or via IEC bus. Addresses 0 to 30 are permissible.

Manually:

- Call UTILITIES-SYSTEM-GPIB-ADDRESS menu
- Enter desired address
- Terminate input using the [1x/ENTER] key

Via IEC bus:

<pre>CALL IBFIND("DEV1", generator%) CALL IBPAD(generator%, 28)</pre>	<pre>CALL IBWRT(generator%, "SYST:COMM:GPIB:ADDR 20") CALL IBPAD(generator%, 20)</pre>	<p>Open port to the instrument Inform controller about old address</p> <p>Set instrument to new address Inform controller about new address</p>
---	--	---

3.2.1.2 Indications during Remote Control

The state of the remote control is evident by the words "IEC REMOTE" or "LOCAL" on the STATUS page. The STATUS page is always displayed in the REMOTE state. LOCKED indicates that the key [LOCAL] is disabled, i.e. switchover to manual operation is only possible via IEC/IEEE bus. With UNLOCKED indicated, switchover to manual control is possible via the key [LOCAL] (see also section 3.2.1.3).

3.2.1.3 Return to Manual Operation

Return to manual operation is possible via the front panel or the IEC bus.

Manually: ➤ Press the [LOCAL] key.

Notes:

- Before switchover, command processing must be completed as otherwise switchover to remote control is effected immediately.
- The [LOCAL] key can be disabled by the universal command LLO (see annex A) in order to prevent unintentional switchover. In this case, switchover to manual mode is only possible via the IEC bus.
- The [LOCAL] key can be enabled again by deactivating the REN control line of the IEC bus (see annex A).

Via IEC bus:

<pre>... CALL IBLOC(generator%) ...</pre>	<p>Set instrument to manual operation.</p>
---	--

3.2.2 Remote Control via RS-232-Interface

3.2.2.1 Setting the Transmission Parameters

To enable an error-free and correct data transmission, the parameters of the unit and the controller should have the same setting. To prevent any problems during binary data transmission, the RS-232 interface is set for 8 data bits, no parity and 1 stop bit. This data format corresponds to the current IEEE P1174 standard. Parameters baud rate and handshake can be manually changed in menu UTILITIES-SYSTEM-RS-232.

- Call UTILITIES-SYSTEM-GPIB-RS232 menu
- Select desired baudrate and handshake
- Terminate input using the [1x/ENTER] key

3.2.2.2 Indications during Remote Control

The state of the remote control is evident by the words "RS-232 REMOTE" or "LOCAL" on the STATUS page. The STATUS page is always displayed in the REMOTE state.

3.2.2.3 Return to Manual Operating

Return to manual operation is possible via the front panel.

- Press the [LOCAL] key.

Note: Before switchover, command processing must be completed as otherwise switchover to remote control is effected immediately.

3.3 Messages

The messages transferred via the data lines of the IEC bus (see annex A) can be divided into two groups:

- **interface messages** and
- **device messages.**

3.3.1 Interface Message

Interface messages are transferred on the data lines of the IEC bus, the ATN control line being active. They are used for communication between controller and instrument and can only be sent by a controller which has the IEC-bus control. Interface commands can be subdivided into

- **universal commands** and
- **addressed commands.**

Universal commands act on all devices connected to the IEC bus without previous addressing, addressed commands only act on devices previously addressed as listeners. The interface messages relevant to the instrument are listed in annex A.

Some control characters are defined for the control of the RS-232-interface (see annex A)

3.3.2 Device Messages (Commands and Device Responses)

Device messages are transferred on the data lines of the IEC bus, the "ATN" control line not being active. ASCII code is used. The device messages are largely identical for the two interfaces (IEC bus and RS232).

A distinction is made according to the direction in which they are sent on the IEC bus:

- **Commands** are messages the controller sends to the instrument. They operate the device functions and request information.
The commands are subdivided according to two criteria:
 1. According to the effect they have on the instrument:
 - Setting commands** cause instrument settings such as reset of the instrument or setting the output level to 1 volt.
 - Queries** cause data to be provided for output on the IEC-bus, e.g. for identification of the device or polling the active input.
 2. According to their definition in standard IEEE 488.2:
 - Common Commands** are exactly defined as to their function and notation in standard IEEE 488.2. They refer to functions such as management of the standardized status registers, reset and selftest.
 - Device-specific commands** refer to functions depending on the features of the instrument such as frequency setting. A majority of these commands has also been standardized by the SCPI committee (cf. Section 3.4.1).
- **Device responses** are messages the instrument sends to the controller after a query. They can contain measurement results, instrument settings and information on the instrument status (cf. Section 3.4.4).

Structure and syntax of the device messages are described in Section 3.4. The commands are listed and explained in detail in Section 3.5.

3.4 Structure and Syntax of the Device Messages

3.4.1 SCPI Introduction

SCPI (Standard Commands for Programmable Instruments) describes a standard command set for programming instruments, irrespective of the type of instrument or manufacturer. The goal of the SCPI consortium is to standardize the device-specific commands to a large extent. For this purpose, a model was developed which defines the same functions inside a device or for different devices. Command systems were generated which are assigned to these functions. Thus it is possible to address the same functions with identical commands. The command systems are of a hierarchical structure. Fig. 3-1 illustrates this tree structure using a section of command system SOURce, which operates the signal sources of the devices. The other examples concerning syntax and structure of the commands are derived from this command system.

SCPI is based on standard IEEE 488.2, i.e. it uses the same syntactic basic elements as well as the common commands defined in this standard. Part of the syntax of the device responses is defined with greater restrictions than in standard IEEE 488.2 (see Section 3.4.4, Responses to Queries).

3.4.2 Structure of a Command

The commands consist of a so-called header and, in most cases, one or more parameters. Header and parameter are separated by a "white space" (ASCII code 0 to 9, 11 to 32 decimal, e.g. blank). The headers may consist of several key words. Queries are formed by directly appending a question mark to the header.

Note: The commands used in the following examples are not in every case implemented in the instrument.

Common Commands

Common commands consist of a header preceded by an asterisk "*" and one or several parameters, if any.

Examples: *RST RESET, resets the device
 *ESE 253 EVENT STATUS ENABLE, sets the bits of the event status enable registers
 *ESR? EVENT STATUS QUERY, queries the contents of the event status register.

Device-specific commands

Hierarchy:

Device-specific commands are of hierarchical structure (see Fig. 3-1). The different levels are represented by combined headers. Headers of the highest level (root level) have only one key word. This key word denotes a complete command system.

Example: SOURce This key word denotes the command system SOURce.

For commands of lower levels, the complete path has to be specified, starting on the left with the highest level, the individual key words being separated by a colon ":".

Example: SOURce:FM:EXTernal:COUPling AC

This command lies in the fourth level of the SOURce system. It sets the coupling of the external signal source to AC.

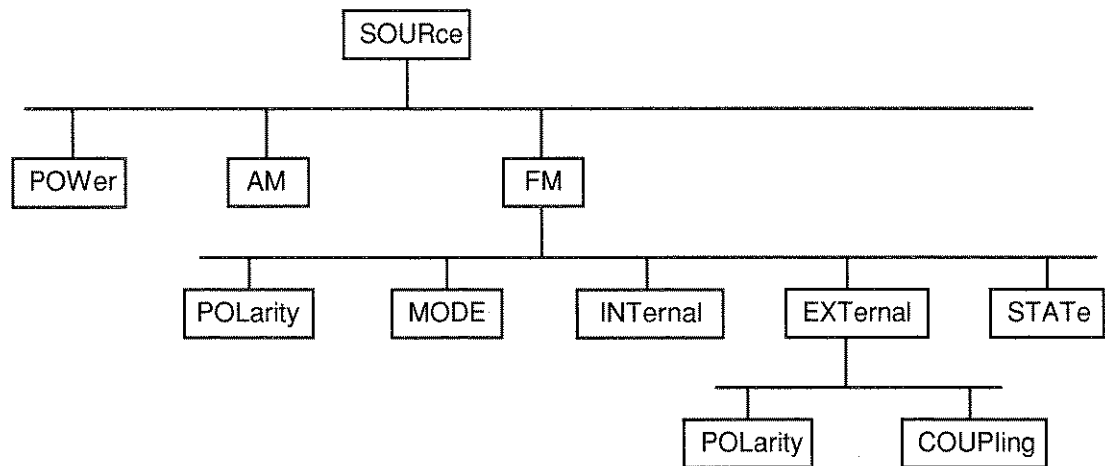

Fig. 3-1 Tree structure of the SCPI command systems using the SOURce system by way of example

Some key words occur in several levels within one command system. Their effect depends on the structure of the command, that is to say, at which position in the header of a command they are inserted.

Example: `SOURce:FM:POLarity NORMal`

This command contains key word POLarity in the third command level. It defines the polarity between modulator and modulation signal.

`SOURce:FM:EXTernal:POLarity NORMal`

This command contains key word POLarity in the fourth command level. It defines the polarity between modulation voltage and the resulting direction of the modulation only for the external signal source indicated.

Optional key words:

Some command systems permit certain key words to be optionally inserted into the header or omitted. These key words are marked by square brackets in the description. The full command length must be recognized by the instrument for reasons of compatibility with the SCPI standard. Some commands are considerably shortened by these optional key words.

Example: `[SOURce]:POWer[:LEVel][:IMMediate]:OFFSet 1`

This command immediately sets the offset of the signal to 1 volt. The following command has the same effect:

`POWer:OFFSet 1`

Note: *An optional key word must not be omitted if its effect is specified in detail by a numeric suffix.*

Long and short form:

The key words feature a long form and a short form. Either the short form or the long form can be entered, other abbreviations are not permissible.

Example: `STATus:QUESTionable:ENABLE 1= STAT:QUES:ENAB 1`

Note: *The short form is marked by upper-case letters, the long form corresponds to the complete word. Upper-case and lower-case notation only serve the above purpose, the instrument itself does not make any difference between upper-case and lower-case letters.*

Parameter:

The parameter must be separated from the header by a "white space". If several parameters are specified in a command, they are separated by a comma ",". A few queries permit the parameters MINimum, MAXimum and DEFault to be entered. For a description of the types of parameter, refer to Section 3.4.5.

Example: `SOURce:POWer:ATTenuation? MAXimum Response:60`

This query requests the maximal value for the attenuation.

Numeric suffix:

If a device features several functions or features of the same kind, e.g. inputs, the desired function can be selected by a suffix added to the command. Entries without suffix are interpreted like entries with the suffix 1.

Example: `SOURce:FM:EXTernal2:COUPLing AC`

This command sets the coupling of the second external signal source.

3.4.3 Structure of a Command Line

A command line may consist of one or several commands. It is terminated by a <New Line>, a <New Line> with EOI or an EOI together with the last data byte. Quick BASIC automatically produces an EOI together with the last data byte.

Several commands in a command line are separated by a semicolon ";". If the next command belongs to a different command system, the semicolon is followed by a colon.

Example:

```
CALL IBWRT(generator%, "SOURCE:POWER:CENTer MINimum;:OUTPut:ATTenuation 10")
```

This command line contains two commands. The first command is part of the SOURCE system and is used to specify the center frequency of the output signal. The second command is part of the OUTPut system and sets the attenuation of the output signal.

If the successive commands belong to the same system, having one or several levels in common, the command line can be abbreviated. To this end, the second command after the semicolon starts with the level that lies below the common levels (see also Fig. 3-1). The colon following the semicolon must be omitted in this case.

Example:

```
CALL IBWRT(generator%, "SOURCE:FM:MODE LOCKed;:SOURCE:FM:INTernal:FREQuency 1kHz")
```

This command line is represented in its full length and contains two commands separated from each other by the semicolon. Both commands are part of the SOURCE command system, subsystem FM, i.e. they have two common levels.

When abbreviating the command line, the second command begins with the level below SOURCE:FM. The colon after the semicolon is omitted.

The abbreviated form of the command line reads as follows:

```
CALL IBWRT(generator%, "SOURCE:FM:MODE LOCKed;INTernal:FREQuency 1kHz")
```

However, a new command line always begins with the complete path.

Example:

```
CALL IBWRT(generator%, "SOURCE:FM:MODE LOCKed")
CALL IBWRT(generator%, "SOURCE:FM:INTernal:FREQuency 1kHz")
```

3.4.4 Responses to Queries

A query is defined for each setting command unless explicitly specified otherwise. It is formed by adding a question mark to the associated setting command. According to SCPI, the responses to queries are partly subject to stricter rules than in standard IEEE 488.2.

1. The requested parameter is transmitted without header.

Example: SOURCE:EXTernal:COUPling? Response: AC

2. Maximum values, minimum values and all further quantities, which are requested via a special text parameter are returned as numerical values.

Example: FREQuency? MAX Response: 10E3

3. Numerical values are output without a unit. Physical quantities are referred to the basic units or to the units set using the Unit command.

Example: FREQuency? Response: 1E6 for 1 MHz

4. Truth values <Boolean values> are returned as 0 (for OFF) and 1 (for ON).

Example: OUTPut:STATe? Response: 1

5. Text (character data) is returned in a short form (see also Section 3.4.5).

Example: SOURCE:FM:SOURCE? Response: INT

3.4.5 Parameter

Most commands require a parameter to be specified. The parameters must be separated from the header by a "white space". Permissible parameters are numerical values, Boolean parameters, text, character strings and block data. The type of parameter required for the respective command and the permissible range of values are specified in the command description (see Section 3.5).

Numerical values Numerical values can be entered in any form, i.e. with sign, decimal point and exponent. Values exceeding the resolution of the instrument are rounded up or down. The mantissa may comprise up to 255 characters, the exponent must lie inside the value range -32000 to 32000. The exponent is introduced by an "E" or "e". Entry of the exponent alone is not permissible. In the case of physical quantities, the unit can be entered. Permissible unit prefixes are G (giga), MA (mega), MOHM and MHZ are also permissible), K (kilo), M (milli), U (micro) and N (nano). If the unit is missing, the basic unit is used.

Example: `SOURce:FREQuency 1.5 kHz = SOURce:FREQuency 1.5E3`

Special numerical values The texts MINimum, MAXimum, DEFault, UP and DOWN are interpreted as special numerical values.

In the case of a query, the numerical value is provided.

Example: Setting command: `SOURce:VOLTage MAXimum`
 Query: `SOURce:VOLTage?` Response: 15

MIN/MAX MINimum and MAXimum denote the minimum and maximum value.

DEF DEFault denotes a preset value which has been stored in the EPROM. This value conforms to the default setting, as it is called by the *RST command.

UP/DOWN UP, DOWN increases or reduces the numerical value by one step. The step width can be specified via an allocated step command (see annex C, List of Commands) for each parameter which can be set via UP, DOWN.

INF/NINF INFINITY, Negative INFINITY (NINF) represent the numerical values -9.9E37 or 9.9E37, respectively. INF and NINF are only sent as device responses.

NAN Not a Number (NAN) represents the value 9.91E37. NAN is only sent as device response. This value is not defined. Possible causes are the division of zero by zero, the subtraction of infinite from infinite and the representation of missing values.

Boolean Parameters Boolean parameters represent two states. The ON state (logically true) is represented by ON or a numerical value unequal to 0. The OFF state (logically untrue) is represented by OFF or the numerical value 0. 0 or 1 is provided in a query.

Example: Setting command: `SOURce:FM:STATE ON`
 Query: `SOURce:FM:STATE?` Response: 1

Text Text parameters observe the syntactic rules for key words, i.e. they can be entered using a short or long form. Like any parameter, they have to be separated from the header by a white space. In the case of a query, the short form of the text is provided.

Example: Setting command: `OUTPut:FILTer:TYPE External`
 Query: `OUTPut:FILTer:TYPE?` Response: EXT

Strings Strings must always be entered in quotation marks (' or ").

Example: `SYSTem:LANGUage "SCPI"` or
`SYSTem:LANGUage 'SCPI'`

Block data

Block data are a transmission format which is suitable for the transmission of large amounts of data. A command using a block data parameter has the following structure:

Example: `HEADer:HEADer #45168xxxxxxxx`

ASCII character # introduces the data block. The next number indicates how many of the following digits describe the length of the data block. In the example the 4 following digits indicate the length to be 5168 bytes. The data bytes follow. During the transmission of these data bytes all End or other control signs are ignored until all bytes are transmitted. Data elements comprising more than one byte are transmitted with the byte being the first which was specified by SCPI command "FORMat:BORDer". Here, the command :SYSTem:COMMunicate:GPiB:LTERminator EOI should be used to set the delimiter mode to 'circuit message EOI only' so that an accidental LF within the data sequence is not first identified as a delimiter and thus momentarily interrupts the data transmission. The command ...LTER STANdard resets the delimiter mode.

The format of the binary files within the block depends on the IEC-bus command

The commands

```
:SOURce:LIST:DWELL
:SOURce:LIST:FREQuency
:SOURce:LIST:POWer
:SOURce:CORREction:CSET:DATA:FREQuency
:SOURce:CORREction:CSET:DATA:POWer
:SYSTem:MSEQuence:DWELL
:SYSTem:MSEQuence:RCL
```

use the IEEE-754 format for double precision floating point numbers. Each number is represented by 8 bytes.

Example:

a# = 125.345678E6

b# = 127.876543E6

```
CALL IBWRT(generator%, "SOURCE:CORRECTION:CSET:DATA:FREQ
#216" + MKD$(a#) + MKD$(b#))
```

- '#' in the command string introduces the binary block,
- '2' indicates that 2 digits specifying the length will follow next,
- '16' is the length of the binary block (in bytes), here: 2 double precision floating point number with 8 bytes each.
- The actual binary data follow now. As the function IBWRT requires a text string, MKD\$ is used for the type conversion.

The following ASCII format has the same effect:

```
CALL IBWRT(generator%, "SOURCE:CORRECTION:CSET:DATA:FREQ
125.345678E6, 127.876543E6")
```

3.4.6 Overview of Syntax Elements

The following survey offers an overview of the syntax elements.

- :** The colon separates the key words of a command.
In a command line the separating semicolon marks the uppermost command level.

- ;** The semicolon separates two commands of a command line.
It does not alter the path.
- ,** The comma separates several parameters of a command.
- ?** The question mark forms a query.
- *** The asterix marks a common command.
- "** Quotation marks introduce a string and terminate it.
- #** ASCII character # introduces block data.
- A "white space" (ASCII-Code 0 to 9, 11 to 32 decimal, e.g. blank) separates header and parameter.

3.5 Description of Commands

3.5.1 Notation

In the following sections, all commands implemented in the instrument are first listed in tables and then described in detail, separated according to the command system. The notation corresponds to the one of the SCPI standards to a large extent. The SCPI conformity information can be taken from the list of commands in annex C.

Table of Commands

Command:	In the command column, the table provides an overview of the commands and their hierarchical arrangement (see indentations).
Parameter:	In the parameter column the requested parameters are indicated together with their specified range.
Unit:	The unit column indicates the basic unit of the physical parameters.
Remark:	In the remark column an indication is made on <ul style="list-style-type: none"> - whether the command does not have a query form, - whether the command has only one query form, - whether this command is implemented only with a certain option of the instrument.

Indentations

The different levels of the SCPI command hierarchy are represented in the table by means of indentations to the right. The lower the level is, the farther the indentation to the right is. Please observe that the complete notation of the command always includes the higher levels as well.

Example: `SOURCE:FM:MODE` is represented in the table as follows:

<code>SOURCE</code>	first level
<code>:FM</code>	second level
<code>:MODE</code>	third level

In the individual description, the complete notation of the command is given. An example for each command is written out at the end of the individual description.

Upper/lower case notation

Upper/lower case letters serve to mark the long or short form of the key words of a command in the description (see Section 3.4.2). The instrument itself does not distinguish between upper and lower case letters.

Special characters |

A selection of key words with an identical effect exists for several commands. These key words are indicated in the same line, they are separated by a vertical stroke. Only one of these key words has to be indicated in the header of the command. The effect of the command is independent of which of the key words is indicated.

Example: `SOURce`
 `:FREQuency`
 `:CW|:FIXed`

The two following commands of identical meaning can be formed. They set the frequency of the constantly frequent signal to 1 kHz:

`SOURce:FREQuency:CW 1E3 = SOURce:FREQuency:FIXed 1E3`

A vertical stroke in indicating the parameters marks alternative possibilities in the sense of "or". The effect of the command is different, depending on which parameter is entered.

Example: Selection of the parameters for the command

`SOURce:COUPling AC | DC`

If parameter AC is selected, only the AC content is fed through, in the case of DC, the DC as well as the AC content.

- [] Key words in square brackets can be omitted when composing the header (cf. Section 3.4.2, Optional Keywords). The full command length must be accepted by the instrument for reasons of compatibility with the SCPI standards.
Parameters in square brackets can optionally be incorporated in the command or omitted as well.
- { } Parameters in braces can optionally be incorporated in the command either not at all, once or several times.

3.5.2 Common Commands

The common commands are taken from the IEEE 488.2 (IEC 625-2) standard. Some commands have the same effect on different devices. The headers of these commands consist of an asterisk "*" followed by three letters. Many common commands refer to the status reporting system which is described in detail in Section 3.7.

Table 3-1 Common Commands

Command	Parameter	Unit	Remark
*CLS			No query
*ESE	0 to 255		
*ESR?			Only query
*IDN?			Only query
*IST?			Only query
*OPC			
*OPT?			Only query
*PRE	0 to 255		
*PSC	0 1		
*RCL	0 to 50		No query
*RST			No query
*SAV	1 to 50		No query
*SRE	0 to 255		
*STB?			Only query
*TRG			No query
*TST?			Only query
*WAI			No query

*CLS

CLEAR STATUS sets the status byte (STB), the standard event register (ESR) and the EVENT-part of the QUESTIONable and the OPERATION register to zero. The command does not alter the mask and transition parts of the registers. It clears the output buffer

*ESE 0 to 255

EVENT STATUS ENABLE sets the event status enable register to the value indicated. Query *ESE? returns the contents of the event status enable register in decimal form.

***ESR?**

STANDARD EVENT STATUS QUERY returns the contents of the event status register in decimal form (0 to 255) and subsequently sets the register to zero.

***IDN?**

IDENTIFICATION QUERY queries the instrument identification.

The device response is for example: "Rohde&Schwarz, SMIQ03,00000001, 1.03"

03 = variant identification

00000001= serial number

1.03 = firmware version number

***IST?**

INDIVIDUAL STATUS QUERY returns the contents of the IST flag in decimal form (0 | 1). The IST flag is the status bit which is sent during a parallel poll (cf. Section 3.6.3.2).

***OPC**

OPERATION COMPLETE sets bit 0 in the event status register when all preceding commands have been executed. This bit can be used to initiate a service request (cf. Section 3.6).

***OPT?**

OPTION IDENTIFICATION QUERY queries the options included in the instrument and returns a list of the options installed. The options are separated from each other by means of commas. For every option, a fixed position is provided in the response.

Table 3-2 Device Response to *OPT?

Position	Option	
1	SM-B1	Reference oscillator OCXO
2	SM-B5	FM/PM modulator
3	SMIQ-B10	Modulation coder
4	SMIQ-B11	Data generator
5	SMIQ-B12	Memory extension for SMIQ-B11
6	SMIQ-B12	Second memory extension
7	SMIQ-B14	Fading simulator
8	SMIQ-B14	Second fading simulator
9	SMIQ-B16	Broadband FM

Example for a device response:

SM-B1, SM-B5, SMIQB10, SMIQB11, SMIQB12, SMIQB12, SMIQB14, SMIQB15, 0

***PRE** 0 to 255

PARALLEL POLL REGISTER ENABLE sets the parallel poll enable register to the value indicated. Query *PRE? returns the contents of the parallel poll enable register in decimal form.

***PSC** 0 | 1

POWER ON STATUS CLEAR determines whether the contents of the ENABLE registers is maintained or reset in switching on.

*PSC = 0 causes the contents of the status registers to be maintained. Thus a service request can be triggered in switching on in the case of a corresponding configuration of status registers ESE and SRE.

*PSC ≠ 0 resets the registers.

Query *PSC? reads out the contents of the power-on-status-clear flag. The response can be 0 or 1.

***RCL** 0 to 50

RECALL calls the instrument state which was stored under the number supplied using command *SAV. 50 instrument states can be stored.

***RST**

RESET sets the instrument to a defined default status. The command essentially corresponds to pressing the [PRESET] key. The state of the RF-output is an exception: The RF-output is deactivated after *RST, however, it is activated after the [RESET] key has been pressed. The default setting is indicated in the description of the commands.

***SAV** 1 to 50

SAVE stores the current instrument state under the number indicated (cf. *RCL as well).

***SRE** 0 to 255

SERVICE REQUEST ENABLE sets the service request enable register to the value indicated. Bit 6 (MSS mask bit) remains 0. This command determines under which conditions a service request is triggered. Query *SRE? reads the contents of the service request enable register in decimal form. Bit 6 is always 0.

***STB?**

READ STATUS BYTE QUERY reads out the contents of the status byte in decimal form.

***TRG**

TRIGGER triggers all actions waiting for a trigger event. Special trigger events can be started by command system "TRIGger" (see section "TRIGger System").

***TST?**

SELF TEST QUERY triggers all selftests of the instrument indicated in Chapter 4, Section "Functional Test" and outputs an error code in decimal form.

***WAI**

WAIT-to-CONTINUE only permits the servicing of the subsequent commands after all preceding commands have been executed and all signals have settled (cf. Section 3.6 and "*OPC" as well).

3.5.3 ABORt System

The ABORt system contains the commands to abort actions triggered. After an action has been aborted, it can be triggered again at once. All commands trigger an event, thus they have no *RST value.

Further commands for the trigger system of the SMIQ can be found in the TRIGger system.

Command	Parameter	Default Unit	Remark
:ABORt [:SWEep] :LIST :MSEquence			No query No query No query

:ABORt[:SWEep]

The command aborts a sweep.

Example: :ABOR:SWE

:ABORt:LIST

The command aborts a list execution.

Example: :ABOR:LIST

:ABORt:MSEquence

The command aborts a Memory Sequence.

Example: :ABOR:MSEQ

3.5.4 CALibration-System

The CALibration system contains the commands to calibrate the SMIQ. On triggering the calibration by means of :MEASure, response "0" displays a faultless calibration, response "1" means that an error has occurred during calibration. As to the meaning of the data in the case of query :DATA?, cf. Chapter 2, Section "Calibration".

Command	Parameter	Default Unit	Remark
:CALibration			
:ALL			
:FSIM			
[MEASure]?			Query only
:LATTenuation			
[:MEASure]			Query only
:LEVel			
:DATA?			Query only
:STAtE	ON OFF		
:LPReset			
[:MEASure]?			Query only
:DATA?	0 to 4095		Query only
:ROSCillator			
[:DATA]	0 to 4095		
:VSUMmation			
[:MEASure]?			Query only
:OFFS?			Query only
:DAC?			Query only
:KOS?			Query only
:VMODulation			
[:MEASure]?			Query only

:CALibration[:ALL]?

This command triggers all internal calibrations which do not require any external measuring equipment. The command triggers an event and thus has no *RST value.

Example: :CAL:ALL?

:CALibration:FSIM[:MEASure]?

The command triggers a calibration measurement of the DC offset of the fading simulator. The command triggers an event and thus has no *RST value.

Example: :CAL:FSIMM?

:CALibration:LATTenuation[:MEASure]?

The command triggers a calibration measurement of the level attenuation of function envelope control. The command triggers an event and thus has no *RST value.

Example: :CAL:LPR:MEAS?

Response: 0

:CALibration:LEVel

This node provides the commands for the management of the level correction table. The corresponding data are permanently stored in the instrument and cannot be changed. The instrument includes different level correction tables. The tables to be used are selected depending on the set frequency and modulation type. The `:STATe ON` command activates the level correction table corresponding to the instrument setup.

:CALibration:LEVel:DATA?

The command queries the level correction data. It returns all level correction data in the format fixed in the `:FORMat` system.

Example: `:CAL:LEV:DATA?`

:CALibration:LEVel:STATe ON | OFF

The command switches on or off internal level correction.

*RST value is ON.

Example: `:CAL:LEV:STAT OFF`

:CALibration:LPReset

The commands to measure the values for the level presetting table are under this node (Level Preset).

:CALibration:LPReset[:MEASure]?

The command triggers a calibration measurement. The command triggers an event and thus has no *RST value.

Example: `:CAL:LPR:MEAS?`

Response: 0

:CALibration:LPReset:DATA?

The command queries the correction data. It returns all correction data in the format fixed in the `:FORMat` system.

Example: `:CAL:LPR:DATA?`

:CALibration:ROSCillator

The commands to calibrate the reference oscillator are under this node.

:CALibration:ROSCillator[:DATA] 0 to 4095

The command enters the correction data. For an exact definition of the calibration value, cf. Section 2.

Example: `:CAL:ROSC:DATA 2048`

:CALibration:VSUMmation

The commands to determine the support values for the frequency setting are under this node.

:CALibration:VSUMmation [:MEASure]?

The command triggers a calibration measurement. The command triggers an event and thus has no *RST value.

Example: :CAL:VSUM:MEAS?

Answer: 0

:CALibration:VSUMmation:OFFS?**:CALibration:VSUMmation:DAC?****:CALibration:VSUMmation:KOS?**

The commands query the calibration data (see service manual). they return all correction data in the format fixed in the :FORMat system.

Example: :CAL:VSUM:OFFS?

:CALibration:VMODulation[:MEASure]?

This command triggers a calibration measurement for the vector modulation. Since it triggers an event it has no default setting value.

Example: :CAL:VMOD:MEAS?

Answer: 0

3.5.5 DIAGnostic-System

The DIAGnostic system contains the commands for diagnostic test and service of the instrument. SCPI does not define DIAGnostic commands, the commands listed here are SMIQ-specific. All DIAGnostic commands are queries which are not influenced by *RST. Hence no default setting values are stated.

Command	Parameter	Default Unit	Remark
:DIAGnostic			
:INFO			
:CCOunt			
:ATTenuator1 2 3 4 5 6?			Query only
:POWer?			Query only
:MODules?			Query only
:OTIME?			Query only
:SDATe?			Query only
[:MEASure]			
:POINt?			Query only

:DIAGnostic:INFO

The commands which can be used to query all information which does not require hardware measurement are under this node.

:DIAGnostic:INFO:CCOunt

The commands which can be used to query all counters in the instrument are under this node (Cycle COunt).

:DIAGnostic:INFO:CCOunt:ATTenuator 1 | 2 | 3 | 4 | 5 | 6?

The command queries the number of switching processes of the different attenuator stages. The stages are designated with Z1 to Z6 within the instrument. In this command they are differentiated by a numeric suffix whose name corresponds to the number:

Suffix	Name	Function
1	Z1	40-dB stage
2	Z2	20-dB stage
3	Z3	5-dB stage
4	Z4	20-dB stage
5	Z5	10-dB stage
6	Z6	40-dB stage

Example: :DIAG:INFO:CCO:ATT1?

Response: 1487

:DIAGnostic:INFO:CCOunt:POWer?

The command queries the number of switch-on processes.

Example: :DIAG:INFO:CCO:POW?

Response: 258

:DIAGnostic:INFO:MODules?

The command queries the modules existing in the instrument with their model and state-of-modification numbers. The response supplied is a list in which the different entries are separated by commas. The length of the list is variable and depends on the equipment of the instrument. Each entry consists of three parts which are separated by means of blanks:

1. Name of module;
2. Variant of module in the form VarXX (XX = 2 digits)
3. Revision of module in the form RevXX (XX = 2 digits)

Example :DIAG:INFO:MOD? Response: FRO Var01 Rev00, DSYN Var03 Rev12, to

:DIAGnostic:INFO:OTIME?

The command reads out the internal operating-hours counter. The response supplies the number of hours the instrument has been in operation up to now.

Example: :DIAG:INFO:OTIM? Response: 19

:DIAGnostic:INFO:SDATe?

The command queries the date of software creation. The response is returned in the form year, month, day.

Example: :DIAG:INFO:SDAT? Response: 1992, 12, 19

:DIAGnostic[:MEASure]

The commands which trigger a measurement in the instrument and return the measured value are under this node.

:DIAGnostic[:MEASure]:POINT?

The command triggers a measurement at a measuring point and returns the voltage measured. The measuring point is specified by a numeric suffix (cf. service manual, stock no. 1106.3409.24).

Example: :DIAG:MEAS:POIN2? Response: 3.52

3.5.6 DISPLAY-System

This system contains the commands to configure the screen. If system security is activated using command `SYSTem:SECurity ON`, the display cannot be switched on and off arbitrarily (cf. below)

Command	Parameter	Default Unit	Remark
<code>:DISPlay</code>			
<code>:ANNotation</code>			
<code>[:ALL]</code>	ON OFF		
<code>:AMPLitude</code>	ON OFF		
<code>:FREQuency</code>	ON OFF		

`:DISPlay:ANNotation`

The commands determining whether frequency and amplitude are indicated are under this node.

Caution: *With SYSTem:SECurity ON, the indications cannot be switched from OFF to ON. In this case *RST does not influence the ANNotation settings either. With SYSTem:SECurity OFF, the *RST value is ON for all ANNotation parameters.*

`:DISPlay:ANNotation[:ALL] ON | OFF`

The command switches the frequency and amplitude indication on or off.

Command `:DISPlay:ANNotation:ALL ON` can only be executed if `SYSTem:SECurity` is set to OFF.

With `SECurity OFF` - *RST value is ON.

Example: `:DISP:ANN:ALL ON`

`:DISPlay:ANNotation:AMPLitude ON | OFF`

The command switches on or off the amplitude indication.

Command `:DISPlay:ANNotation:AMPLitude ON` can only be executed if `SYSTem:SECurity` is set to OFF.

With `SYSTem:SECurity OFF` - *RST value is ON.

Example: `:DISP:ANN:AMPL ON`

`:DISPlay:ANNotation:FREQuency ON | OFF`

The command switches on or off the frequency indication.

Command `:DISPlay:ANNotation:FREQuency ON` can only be executed if `SYSTem:SECurity` is set to OFF.

With `SYSTem:SECurity OFF` - *RST value is ON.

Example: `:DISP:ANN:FREQ ON`

3.5.7 FORMat-System

This system contains the commands determining the format of the data the SMIQ returns to the controller. All queries returning a list of numeric data or block data are concerned. With each of these commands, this connection is pointed to in the description.

Command	Parameter	Default Unit	Remark
<code>:FORMat</code> <code>[:DATA]</code> <code>:BORDer</code>	ASCIi PACKed NORMal SWAPPed		

:FORMat[:DATA] ASCII | PACKed

The command specifies the data format, that the SMIQ uses for returning the data. When data are transmitted from the controller to the SMIQ, the SMIQ recognizes the data format automatically. In this case, the value specified here has no significance.

Note: Settings using the FORMat:DATA command are only effective for commands with which this is stated in the command description.

ASCIi Numeric data are transmitted in plain text, separated by commas.

PACKed Numerical data are transmitted as binary block data. The format of the binary data itself is command-specific. Its description can be found in Section 3.4.5.

Example: :FORM:DATA ASC *RST value is ASCII

:FORMat:BORDer NORMAL | SWAPPed

This command defines the order of bytes inside a binary block. This concerns only blocks which use the IEEE754 format internally (see section 3.4.5, paragraph "Block Data").

NORMAL: The SMIQ expects (for setting commands) and sends (for queries) first the most significant byte of each IEEE-754 floating point number, last the least significant byte. For hosts based on a 80x86 processor this corresponds to the configuration of bytes in the main memory. Thus, no further conversion is required.

SWAPPed: The SMIQ expects (for setting commands) and sends (for queries) first the least significant byte of each IEEE754 floating point number, last the most significant byte.

Example: :FORMat:BORDer:NORMal *RST-value is NORMAL

3.5.8 MEMory System

This system contains the commands for the memory management of the SMIQ.

Command	Parameter	Default Unit	Remark
:MEMory :NSTates?			Query only

:MEMory:NSTates?

The command returns the number of *SAV/*RCL memories available. The SMIQ has 50 *SAV/*RCL memories in total.

Example: :MEM:NST?

Response: 50

3.5.9 OUTPut-System

This system contains the commands specifying the characteristics of the RF output socket and the BLANK socket. The characteristics of the LF socket are specified in the OUTPut2 system.

Command	Parameter	Default Unit	Remark
:OUTPut :AMODe :AFIXed :RANGe :UPPer? :LOWer? :BLANK :POLarity :IMPedance? :PROTection :CLEar :TRIPped? [:STATe] :PON	AUTO FIXed ELECTronic NORMal INVerted ON OFF OFF UNChanged		 Query only Query only Query only Query only

:OUTPut:AMODe AUTO | FIXed

The command switches over the operating mode of the attenuator at the RF output (Attenuator MODE).

AUTO The attenuator is switched whenever possible.

FIXed The attenuator is switched when certain fixed levels are exceeded/fallen below.

ELECTronic The level is additionally (without modifying the attenuator) changed via the IQ modulator.

Example: :OUTP:AMOD AUTO

*RST value is AUTO

:OUTPut:AFIXed RANGE UPPer?

This command queries the maximum level which can be set without modifying the attenuator (Attenuator FIXed).

Example: :OUTP:AFIX:RANG:UPP? Response: -27

:OUTPut:AFIXed RANGE LOWer?

This command queries the minimum level which can be set without modifying the attenuator (Attenuator FIXed).

Example: :OUTP:AFIX:RANG:UPP? Response: -50

:OUTPut:BLANK:POLarity NORMAL | INVerted

The command sets the polarity of the BLANK signal.

NORMAL The active BLANK state is indicated by the more positive or higher output voltage.

INVers The active BLANK state is indicated by the more negative or lower output voltage.

Example: :OUTP:BLAN:POL NORM RST value is NORM

:OUTPut:IMPedance?

The command queries the impedance of the RF output

. This permits converting the output level between units V and W. The impedances cannot be changed. With the SMIQ, this is the fixed value of 50 Ohm for the RF output.

Example: :OUTP:IMP? Response: 50

:OUTPut:PROTection

The commands to configure the protective circuit are under this node. The RF output is protected by a protective circuit which deactivates the output if an overvoltage is supplied from outside. This does not change the value of OUTPut:STATe.

:OUTPut:PROTection:CLEar

The command resets the protective circuit after it has been triggered. The state of the output is determined by OUTPut:STATe again. The command triggers an event and hence has no default setting value.

Example: :OUTP:PROT:CLE

:OUTPut:PROTection:TRIPped?

The command queries the state of the protective circuit. The responses mean:

"0" The protective circuit has not responded

"1" The protective circuit has responded

Example: :OUTP:PROT:TRIP? Response: "1"

:OUTPut[:STATe] ON | OFF

The command switches on or off the RF output. The RF output can also be switched off by the response of the protective circuit. But this has no influence on this parameter.

Note: *In contrast to the PRESET key, command *RST sets this value to OFF, the output is deactivated.*

Example: :OUTP:STAT ON

*RST value is OFF

:OUTPut[:STATe]:PON OFF | UNCHanged

This command selects the state the RF output is to assume after power-on of the unit. It only exists for the RF output. *RST does not influence the set value.

OFF Output is switched off.

UNCHanged Same state as before switch- off

Example: :OUTP:PON OFF

3.5.10 OUTPut2 System

This system contains the commands specifying the characteristics of the LF output socket

Command	Parameter	Default Unit	Remark
:OUTPut2 [:STATe] :VOLTage	ON OFF 0 V to 4 V	V	

:OUTPut2[:STATe] ON | OFF

The command switches the LF output on or off.

*RST value is OFF

Example: :OUTP2:STAT ON

:OUTPut2:VOLTage 0V to 4V

The command sets the voltage of the LF output.

*RST value is 1 V

Example: :OUTP2:VOLT 3.0V

3.5.11 SOURce-System

This system contains the commands to configure the RF signal source. Keyword SOURce is optional, i.e., it can be omitted. The LF signal source is configured in the SOURce2 system.

The following subsystems are realized in the instrument:

Subsystem	Settings
[:SOURce]	
:AM	Amplitude modulation
:CORRection	Correction of the output level
:DECT	Digital standard DECT
:DM	I/Q and digital standard modulations
:FM	Frequency modulation
:FREQuency	Frequencies including sweep
:FSIM	Fading simulator
:GSM	Digital standard GSM
:IS95	Digital standard IS-95 CDMA
:LIST	LIST mode
:MARKer	Marker generation with sweeps
:MBE	Marker signals (Marker Beacon)
:NADC	Digital standard NADC
:PDC	Digital standard PDC
:PHASe	Phase between output signal and reference oscillator signal
:PHS	Digital standard PHS
:PM	Phase modulation
:POWer	Output level, level control and level correction
:PULM	Pulse modulation
:ROSCillator	Reference oscillator
:SWEep	Sweeps

3.5.11.1 SOURce:AM Subsystem

This subsystem contains the commands to control the amplitude modulation. Part if the LF-generator settings is effected under SOURce2.

Command	Parameter	Default Unit	Remark
[:SOURce]			
:AM			
:BBAN			
[:STATe]	ON OFF		
[:DEPTh]	0 to 100 PCT	PCT	
:EXTernal			
:COUPling	AC DC		
:INTernal1 2			
:FREQUency	0.1 Hz to 1 MHz	Hz	
:SOURce	EXT INT EXT, INT		
:STATe	ON OFF		

[:SOURce]:AM:BBANd[:STATe] ON | OFF

The command switches on or off the BB-AM (through the I-input of the IQ-modulator).

Example: `:SOUR:AM:BBAN:STAT ON` *RST value is OFF

[:SOURce]:AM[:DEPTh] 0 to 100PCT

The command sets the modulation depth in percent.

Example: `:SOUR:AM:DEPT 15PCT` *RST value is 30PCT

[:SOURce]:AM:EXTernal:COUPling AC | DC

The command selects the type of coupling for the external AM input.

AC The d.c. voltage content is separated from the modulation signal.

DC The modulation signal is not altered.

Example: `:SOUR:AM:EXT:COUP AC` *RST value is AC

[:SOURce]:AM:INTernal

The settings for the internal AM inputs (LF generator) are effected under this node.

Here the same hardware is set for AM, PM, FM and SOURce2. This means that, for example, the following commands are coupled with each other and have the same effect:

`SOUR:FM:INT:FREQ; SOUR:PM:INT:FREQ; SOUR2:FREQ:CW`

[:SOURce]:AM:INTernal1|2:FREQUency 0.1 Hz to 1MHz

The command sets the modulation frequency.

Example: `:SOUR:AM:INT:FREQ 15kHz` *RST value is 1 kHz

[:SOURce]:AM:SOURce EXT | INT | EXT, INT

The command selects the modulation source. INT is the internal LF generator. The external and the internal modulation source can be indicated at the same time (see example).

Example: `:SOUR:AM:SOUR INT, EXT` *RST value is INT

[:SOURce]:AM:STATe ON | OFF

The command switches amplitude modulation on or off.

Example: `:SOUR:AM:STAT ON` *RST value is OFF

3.5.11.2 SOURce:CORRection Subsystem

The CORRection subsystem permits a correction of the output level. The correction is effected by adding user-defined table values to the output level as a function of the RF frequency. In the SMIQ, this subsystem serves to select, transmit and switch on USER-CORRECTION tables (see Chapter 2, Section "User Correction (UCOR)" as well).

Command	Parameter	Default Unit	Remark
[:SOURce] :CORRection [:STATe] :CSET :CATalog?	ON OFF		Query only
[:SElect] :DATA :FREquency :POWer :DElete	"Name of table" 300 kHz to 2.2 GHz {,300 kHz to 2.2 GHz} -40 dBto 6dB {,-40 dBto 6dB} "Name of table"	Hz dB	SMIQ03: to 3.3 GHz no query

[:SOURce]:CORRection[:STATe] ON | OFF

The command switches the table selected using SOURce:CORRection:CSET on or off.

Example: :SOUR:CORR:STAT ON *RST value is OFF

[:SOURce]:CORRection:CSET

The commands to select and edit the UCOR tables are under this node.

[:SOURce]:CORRection:CSET:CATalog?

The command requests a list of UCOR tables. The individual lists are separated by means of commas. This command is a query and has no *RST value.

Example: :SOUR:CORR:CAT? Answer: "UCOR1", "UCOR2", "UCOR3"

[:SOURce]:CORRection:CSET[:SElect] "Name of table"

The command selects a UCOR table. This command alone does not yet effect a correction. First the table selected must be activated (cf. :SOURce:CORRection:STATe). If there is no table of this name, a new table is created. The name may contain up to 7 letters. This command triggers an event and hence has no *RST value.

Example: :SOUR:CORR:CSET:SEL "UCOR1"

[[:SOURce]:CORRection:CSET:DATA

The commands to edit the UCOR tables are under this node.

[[:SOURce]:CORRection:CSET:DATA:FREQuency 300 kHz to 2.2 GHz {,300 kHz to 2.2 GHz}
(SMIQ03: to 3.3 GHz)

The command transmits the frequency data for the table selected using :SOURce:CORRection:CSET. *RST does not influence data lists.

Example: :SOUR:CORR:CSET:DATA:FREQ 100MHz,102MHz,103MHz,to

[[:SOURce]:CORRection:CSET:DATA:POWer -40dB to 6dB {,-40dB to 6dB}

The command transmits the level data for the table selected using :SOURce:CORRection:CSET. *RST does not influence data lists.

Example: :SOUR:CORR:CSET:DATA:POWer 1dB, 0.8dB, 0.75dB,to

[[:SOURce]:CORRection:CSET:DELeTe "Name of table"

The command deletes the table indicated from the instrument memory. This command triggers an event and hence has no *RST value.

Example: :SOUR:CORR:CSET:DEL "UCOR2"

3.5.11.3 SOURCE:DECT-Subsystem (Digital Standard)

Note #B0 to #BF are characters which are entered in binary form manually. SCPI (and IEEE 488.2) also accept the entry of non-decimal characters in octal and hexadecimal such as #H|h <0 to 9, A|a to F|f>, #Q|q <0 to 7> and #B|b <0|1>.
The characters are always output in Hex format after a query.

Command	Parameter	Default Unit	Remark
[:SOURCE]			
:DECT			
:STATe	ON OFF		
:STANdard			
:FORMat	GFSK P4DQpsk		
:FSK			
:DEVIation	100Hz to 1.2MHz	HZ	range 0.1 to 1 × symbol rate
:SRATe	2k to 1.2M / 1k to 0.6M Hz (GFSK/P4DQ)	Hz	
:FILTer			
:TYPE	GAUSs SCOSine COSine		
:PARAmeter	0.2 to 0.7		
:SEQuence	AUTO RETRigger AAUTO ARETrigger		
:TRIGger			
:SOURce	EXTernal INTernal		
:INHibit	0 to 67.1E6		
:DELay	0 to 65535		
:OUTPut[2]			
:DELay	0 to 11519		
:PERiod	1 to 67.1E6		
:CLOCK			
:SOURce	INTernal EXTernal		
:DELay	0 to 1.0		
:PRAMp			
:PRESet			no query
:TIME	0.25 to 16		
:DELay	-1.0 to +1.0		
:SHAPE	LINear COSine		
:ROFFset	-9 to +9		
:FOFFset	-9 to +9		
:SLOT			
:ATTenuation	0 to 70 dB	dB	

Command	Parameter	Default Unit	Remark
[:SOURce]			
:DECT			
:SIMulation			
:TADJustment	-4 to +4 (Bit)		
:JITTer	0 to 4 (Bit)		
:FLISt			
:PREDefined			
:CATalog?	⇒ name {,name} ...		query only
:LOAD	'name'		no query
:CATalog?	⇒ name {,name} ...		query only
:LOAD	'name'		no query
:STORE	'name'		no query
:DELeTe	'name'		no query
:DLISt			
:CATalog?	⇒ name {,name} ...		query only
:SLOT<i>			i=0,[1],...23 (Slot Selector)
:TYPE	FULL DOUBle ADATa		
:LEVel	OFF ATT FULL		
:PRESet			no query
:STSHift	-9 to +9	(Bit)	
:RAMP			
:CW	ON OFF		
:DATA	#B0 to #B11111111111111 (12 Bit)		
:PREamble			
:TYPE	NORMal PROLonged		
:DATA	#B0 to #B1111111111111111 (16 Bit)		
:PROLonged			
:DATA	#B0 to #B1111111111111111... (32 Bit)		
:SYNC	#B0 to #B1111111111111111 (16 Bit)		
:AFieLd	PN9 PN11 PN15 PN 16 PN20 PN21 PN23 DLISt SDATa		
:DLISt	'name'		
:BFieLd	PN9 PN11 PN15 PN 16 PN20 PN21 PN23 DLISt SDATa		
:DLISt	'name'		
:ZFieLd	ON OFF'		

[[:SOURCE]:DECT:STATe ON | OFF

The command switches the modulation on according to DECT standard. All other standards that might be switched on or digital modulation are automatically switched OFF.

Example: :SOUR:DECT:STAT ON *RST value is OFF

[[:SOURCE]:DECT:STANdard

The command sets all modulation parameters to the values of the DECT standard. It does not set the parameters selected with the :DECT:SLOT... commands described in the following. This command triggers an event and hence has no *RST value and no query.

Example: :SOUR:DECT:STAN

[[:SOURCE]:DECT:FORMat GFSK | P4DQpsk

The command selects the type of modulation.

Example: :SOUR:DECT:FORM P4DQ *RST value is GFSK

[[:SOURCE]:DECT:FSK:DEVIation 1kHz to 300 kHz

The command sets the modulation depth (only for DECT:FORMat GFSK). The range of values depends on the symbol rate (DECT:SRATe \times 0.1 to 1).

Example: :SOUR:DECT:FSK:DEV 300.6kHz *RST value is 288kHz

[[:SOURCE]:DECT:SRATe 1kHz to 1.2 MHz

The command sets the symbol rate. Permissible values for GFSK are 2 kHz to 1.2 MHz and 1 kHz to 0.6 MHz for P4Qpsk.

Example: :SOUR:DECT:SRAT 192.1 kHz *RST value is 1152/576kHz (GFSK/P4DQ)

[[:SOURCE]:DECT:FILTer

The commands for selecting a filter are under this node.

[[:SOURCE]:DECT:FILTer:TYPE GAUSs | SCOSine | COSine

The command selects the type of filter; SCOS and COS can be set for P4DQpsk. For DECT:FORMat GFSK, the GAUSs type is set automatically.

Example: :SOUR:DECT:FILT:TYPE COS *RST value is GAUS/SCOS (GFSK/P4DQ)

[[:SOURCE]:DECT:FILTer:PARAmeter 0.2 to 0.7

The command sets the filter parameter.

Example: :SOUR:DECT:FILT:PAR 0.2 *RST value is 0.5

[[:SOURCE]:DECT:SEQuence AUTO | RETRigger | AAUTo | ARETrigger

The command selects the trigger mode for the sequence.

AAUTo ARMED AUTO

ARETrigger ARMED RETRIG

Example: :SOUR:DECT:SEQ AAUT *RST value is AUTO

[[:SOURce]:DECT:TRIGger:SOURce EXTernal | INTernal

The command selects the trigger source. With INT selected, triggering is via IEC/IEEE bus or the Execute command in manual control.

Example: :SOUR:DECT:TRIG:SOUR EXT *RST value is INT

[[:SOURce]:DECT:TRIGger:INHibit 0 to 67.1E6

The command sets the retrigger inhibit duration (in number of symbols).

Example: :SOUR:DECT:TRIG:INH 1000 *RST value is 0

[[:SOURce]:DECT:TRIGger:DELay 0 to 65535

The command sets the trigger delay (in number of symbols).

Example: :SOUR:DECT:TRIG:DEL 200 *RST value is 0

[[:SOURce]:DECT:TRIGger:OUTPut[2]:DELay 0 to 11519

The command determines the delay of the signal at trigger output 2 in comparison with the start of the frames in number of symbols.

Example: :SOUR:DECT:TRIG:OUTP2:DEL 16 *RST value is 0

[[:SOURce]:DECT:TRIGger:OUTPut[2]:PERiod 1 to 67.1E6

The command sets the repeat rate (in number of frames) of the signal at trigger output 2.

Example: :SOUR:DECT:TRIG:OUTP:PER 8 *RST value is 1

[[:SOURce]:DECT:CLOCK

The commands for setting the data clock are under this node.

[[:SOURce]:DECT:CLOCK:SOURce INTernal | EXTernal

The command selects the source for the DM data clock.

INTernal The internal clock generator is used and output via the clock outputs of the serial and parallel interface.

EXTernal The clock is externally fed in via the serial interface and output via the parallel interface.

Example: :SOUR:DECT:CLOC:SOUR INT *RST value is INT

[[:SOURce]:DECT:CLOCK:DELay 0 to 1.0

The command sets the delay of the symbol clock (as a fraction of the length of a symbol).

Example: :SOUR:DECT:CLOC:DEL 0.75 *RST value is 0

[[:SOURce]:DECT:PRAMP

The commands for the level control of the burst are under this node.

[[:SOURce]:DECT:PRAMP:PRESet

This command sets the standard-stipulated values for the following commands of level control. It is an event and hence has no query and no *RST value.

Example: :SOUR:DECT:PRAMP:PRESet

[[:SOURce]:DECT:PRAMP:TIME 0.25 to 16.0

The command sets the cutoff steepness (in symbol clocks).

Example: :SOUR:DECT:PRAMP:TIME 2.5

*RST value is 2

[[:SOURce]:DECT:PRAMP:DELay -1.0 to +1.0

The command defines the shift of the envelope characteristic to the modulated signal. A positive value causes a delay of the envelope.

Example: :SOUR:DECT:PRAMP:DELay 0.2

*RST value is 0

[[:SOURce]:DECT:PRAMP:SHAPE LINear | COSine

The command selects the linear or cosine shape of the ramp-up and ramp-down (power burst).

Example: :SOUR:DECT:PRAMP:SHAPE LIN

*RST value is COS

[[:SOURce]:DECT:PRAMP:ROFFset -9 to +9

The command determines the timing of the ('R'ising) edge of a power burst to the beginning of the slot.

Example: :SOUR:DECT:PRAMP:ROFFset -3

*RST value is 0

[[:SOURce]:DECT:PRAMP:FOFFset -9 to +9

The command determines the timing of the ('F'alling) edge of a power burst to the data block.

Example: :SOUR:DECT:PRAMP:FOFFset 4

*RST value is 0

[[:SOURce]:DECT:SLOT:ATTenuation 0 to 70 dB

The command determines the amount by which the power of the slots marked by :DECT:SLOT:LEVEL ATT is reduced in comparison with the normal output power (attributed to :LEVEL FULL).

Example: :SOUR:DECT:SLOT:ATT 20 dB

*RST value is 0

[[:SOURce]:DECT:SIMulation:TADJustment -4 to +4 (in bit)

This command simulates the timing adjust by extending every 35th frame by the set number of bits (positive) or by reducing it (negative). 0 bit is off.

Example: :SOUR:DECT:SIM:TADJ 3

*RST value is 0

[[:SOURce]:DECT:SIMulation:JITTer 0 to 4 (in bit)

This command simulates the jitter by advancing even frames by the set number of bits and by delaying uneven frames. 0 bit is off.

Example: :SOUR:DECT:SIM:JITT 2 *RST value is 0

[[:SOURce]:DECT:FLISt

The commands for storing and reading complete frames including their bursts (slots) are under this node. Predefined and user-generated frames have to be distinguished.

[[:SOURce]:DECT:FLISt:PREDefined:CATalog?

The command returns a list of all predefined frames.

Example: :SOUR:DECT:FLIS:PRED:CAT?

[[:SOURce]:DECT:FLISt[:PREDefined]:LOAD 'name'

The command selects one of the predefined (fixed) frames (c.f. Chapter 2). This command triggers an event and hence has no *RST value.

Example: :SOUR:DECT:FLIS:PRED:LOAD 'test'

[[:SOURce]:DECT:FLISt:CATalog?

The command returns a list of all user-defined frames.

Example: :SOUR:DECT:FLIS:CAT?

[[:SOURce]:DECT:FLISt:LOAD 'name'

The command loads a user-defined frame. This command triggers an event and hence has no *RST value.

Example: :SOUR:DECT:FLIS:LOAD 'test'

[[:SOURce]:DECT:FLISt:STORe 'name'

The command stores the current frame under a name. This command triggers an event and hence has no *RST value and no query.

Example: :SOUR:DECT:FLIS:STOR 'test'

[[:SOURce]:DECT:FLISt:DELeTe 'name'

The command deletes the indicated frame. This command triggers an event and hence has no *RST value and no query.

Example: :SOUR:DECT:FLIS:DEL 'test1'

[[:SOURce]:DECT:DLISt:CATalog?

The command returns an enumeration of all data lists.

These data lists are selected by means of :DECT:SLOT:AFI:DLIS 'name' and . . . :BFI:DLIS 'name' and used if :DECT:SLOT:AFI:DLIS and . . . :BFI:DLIS are set.

Example: :SOUR:DECT:DLIS:CAT?

[:SOURce]:DECT:SLOT<i>

The commands for setting the slot characteristics are under this node. Since a frame contains 24 slots, suffix 'i' is used to select the slot to be changed. $i = [1 | 2 \text{ to } | 22 | 23]$. Slot 0 to 11 can be used for downlink and slot 12 to 23 for uplink. For double slot even numbers can be entered only since it occupies two full slots.

[:SOURce]:DECT:SLOT<i>:TYPE FULL | DOUBLE | ADATa

The command selects the type of burst (slot) defined in the standard.

ADATa is All Data; the data source set with `SLOT<i>:SOURce:BFIEld` is used.

Example: `:SOUR:DECT:SLOT2:TYPE ADAT` *RST value is FULL

[:SOURce]:DECT:SLOT<i>:LEVEl OFF | ATT | FULL

The command determines the power stage of the slot.

OFF The slot is inactive

ATT The power is reduced by the amount defined by `:DECT:SLOT:ATT`

FULL Full power (predefined by level setting).

Example: `:SOUR:DECT:SLOT2:LEV ATT` *RST value is FULL

[:SOURce]:DECT:SLOT<i>:PRESet

The command sets all the following parameters of the slot to the values defined by the standard as a function of the type set above. This command triggers an event and hence has no *RST value and no query.

Example: `:SOUR:DECT:SLOT2:PRES`

[:SOURce]:DECT:SLOT<i>:STSHift -9 to +9 (in bit)

This command allows a timing shift of the indicated slot by the set number of bits to simulate a wrong timing (positive = delay; negative = advance).

Example: `:SOUR:DECT:SLOT2:STSH -3` *RST value is 0

[:SOURce]:DECT:SLOT<i>:RAMP:CW ON | OFF

The command activates or deactivates the generation of unmodulated (CW) signal during the ramp time.

Example: `:SOUR:DECT:SLOT2:PRAM:CW ON` *RST value is OFF

[:SOURce]:DECT:SLOT<i>:RAMP:DATA #B0 to #B111 to (12bit)

The command sets the data used during the ramp time.

Example: `:SOUR:DECT:SLOT2:PRAM:DATA #B111100001111`

*RST value is 101010101010 / 010101010101 (downl./uplink)

[:SOURce]:DECT:SLOT<i>:PREamble:TYPE NORMAl | PROLonged

The command selects the 16-bit (NORMAl) or 32-bit (PROLonged) preamble.

Example: `:SOUR:DECT:SLOT2:PRE PROL PRO` *RST value is NORM

[[:SOURce]:DECT:SLOT<i>]:PREamble:DATA #B0 to #B111 to (16bit)

The command sets the data used for the 16-bit long preamble.

Example: :SOUR:DECT:SLOT2:PRE:DATA #B1111000011110000

*RST value is 1010101010101010 / 0101010101010101 (downlink/uplink)

[[:SOURce]:DECT:SLOT<i>]:PREamble:PROLonged:DATA #B0 to #B111 to (32bit)

The command sets the data used for the 32-bit long preamble.

Example: :SOUR:DECT:SLOT2:PRE:PROL:DATA #B1111

*RST value 10101010101010101010101010101010 (downlink)

*RST value 01010101010101010101010101010101 (uplink)

[[:SOURce]:DECT:SLOT<i>]:SYNC #B0 to #B111 to (16bit)

The command sets the data used for synchronization.

Example: :SOUR:DECT:SLOT2:SYNC #B0000111100001111

RST value is 1110100110001010 / 0001011001110101 (downl./uplink)

[[:SOURce]:DECT:SLOT<i>]:SOURce:AFieLd PN9 | PN11 | PN15 | PN16 | PN20 | PN21 | PN23 | DLIS | SDATa

The command defines the data source for the A field. It is either a PRBS generator (of different sequence length), a data list or the serial interface.

Example: :SOUR:DECT:SLOT3:SOUR:AFI PN15

*RST value is PN9

[[:SOURce]:DECT:SLOT<i>]:SOURce:AFieLd:DLIS 'name'

The command selects a data list. This list is used only if lists have been set as data source using the command :DECT:SLOT:SOUR:AFI DLIS. This command triggers an event and hence has no *RST value.

Example: :DECT:SLOT:SOUR:AFI:DLIS 'test'

[[:SOURce]:DECT:SLOT<i>]:SOURce:BFieLd PN9 | PN11 | PN15 | PN16 | PN20 | PN21 | PN23 | DLIS | SDATa

The command determines the data source for the B field. The data source set by means of this command is also used for SLOT:TYPE ADATa. It is either a PRBS generator (of different sequence length), a data list or the serial interface.

Example: :SOUR:DECT:SLOT3:SOUR:BFI PN15

*RST value is PN9

[[:SOURce]:DECT:SLOT<i>]:SOURce:BFieLd:DLIS 'name'

The command selects a data list. This list is used only if lists have been set as data source using the command :DECT:SLOT:SOUR:BFI DLIS. This command triggers an event and hence has no *RST value.

Example: :DECT:SLOT:SOUR:BFI:DLIS 'test'

[[:SOURce]:DECT:SLOT<i>]:ZFieLd ON | OFF

The command activates/deactivates the repetition of the content of the X field.

Example: :SOUR:DECT:SLOT2:ZFI ON

*RST value is ON

3.5.11.4 SOURce:DM Subsystem

In this subsystem, the types of digital standard modulation as well as vector modulation (I/Q modulation) are checked.

Vector Modulation

Command	Parameter	Default Unit	Remark
[:SOURce] :DM :IQ :STATe :PRAMp :IMPairment [:STATe] :LEAKage [:MAGNitude] :QUADrature :ANGLe :IQRatio [:MAGNitude] :IQSWap [:STATe]	ON OFF OFF AEXTernal ON OFF 0 to 50.0 PCT -10.0 to 10.0 DEG -12.0 to 12.0 PCT ON OFF	PCT DEG PCT	

[:SOURce]:DM:IQ:STATe ON | OFF

This command switches vector modulation (I/Q modulation) on or off.

Example: :SOUR:DM:IQ:STAT ON

*RST value: OFF

[:SOURce]:DM:IQ:PRAMp OFF | AEXTernal

This command switches the level control via the input socket (analog external).

Example: :SOUR:DM:IQ:PRAM AEXT

*RST value: OFF

[:SOURce]:DM:IQ:IMPairment[:STATe] ON | OFF

This command activates (ON) or deactivates (OFF) the three tuning or correction values LEAKage, QUADrature and IQRatio for I/Q modulation.

Example: :SOUR:DM:IQ:IMP OFF

*RST value: OFF

[:SOURce]:DM:LEAKage[:MAGNitude] 0 to 50.0 PCT

This command adjusts the residual carrier amplitude for I/Q modulation.

Example: :SOUR:DM:LEAK 3PCT

*RST value: 0

[[:SOURce]:DM:QUADrature:ANGLE] -10.0 to 10.0 degree

This command changes the quadrature offset for I/Q modulation.

Example: :SOUR:DM:QUAD:ANGL -5DEG

*RST value: 0

[[:SOURce]:DM:IQRatio[:MAGNitude] -12.0 to 12.0 PCT

This command adjusts the ratio of I and Q modulation (gain imbalance).

Example: :SOUR:DM:IQR 4PCT

*RST value: 0

[[:SOURce]:DM:IQSWap[:STATE] ON | OFF

This command interchanges the I and Q channels in position ON.

Example: :SOUR:DM:IQSW OFF

*RST value: OFF

Digital Modulation

Command	Parameter	Default unit	Remark
[[:SOURce]			
:DM			
:STATe	ON OFF		
:SEQuence	AUTO RETRigger AAUTo ARETrigger SINGLE		
:SOURce	PRBS PATtern DLISt SERial PARallel SDATa		
:PATtern	ZERO ONE ALTErnate		
:PRBS			
[:LENGth]	9 15 16 20 21 23		
:DLISt			
:DATA	0 1 {,0 1 } or block data		
:DATA?	[<start>[,<length>]]		query
:APPend	0 < 1 {,0 1 } or block data		no query
:CATalog?			query only
:SElect	'name'		
:DElete	'name'		no query
:COpy	'name'		no query
:FREE?			query only
:POINts	<n>		
:CLISt			
:CONTRol			
[:STATe]	ON OFF		
:DATA	<struc> {, <struc>}...		
:CATalog?			query only
:SElect	'name'		
:DElete	'name'		no query
:COpy	'name'		no query
:FREE?			query only
:POINts?			query only
:MLISt			
:DATA	A,B,C,D,E,F, I1, Q1, I2, Q2...		
:CATalog?			
:SElect	'name'		
:DElete	'name'		no query
:FREE?			query only
:POINts?			query only

Command	Parameter	Default unit	Remark
[:SOURce]			
:DM			
:STANdard	APCFm APCQpsk ICOBpsk ICOGmsk ICOQpsk CDPD CT2 DECT GSM IRIDium NADC PDC PHS TETRa TFTS PWT		
:FORMat	GMSK GFSK BPSK QPSK QIS95 QICO QINmarsat OQPSk OIS95 P4QPsK P4DQpsk PSK8 QAM16...256 FSK2 FSK4 AFSK4 USER		
:FSK			
:DEVIation	100 Hz to 2.5 MHz	Hz	
:SRATe	1kHz to 7 MHz	Hz	
:FILTer			
:TYPE	SCOSine COSine GAUSs BESS1 BESS2 IS95 EIS95 APCO TETRa WCDMa		
:PARAmeter	0.1...1.0		
:MODE	LACP LEVM		
:CODing	OFF GSM NADC PDC PHS TETRa PWT TFTS DIFF DGRay DPHS APCO25 INmarsat VDL		
:CLOCK			
:SOURce	INTernal EXTernal COUPlEd		
:MODE	BIT SYMBol		
:DELay	0 to 1.0		
:POLarity	NORMal INVerted		
:LDIStortion			
[:STATe]	ON OFF		
:PRAMP			
[:STATe]	ON OFF		
:SOURce	CLISt AEXTernal DEXTernal		
:TIME	0.25 to 32		
:DELay	-1.0 to 5.0		
:SHAPE	LINear COSine		
:ATTenuation	0 to 70 dB	dB	
:TRIGger			
:SOURce	EXTernal INTernal		
:INHibit	0 to 67.1E6		
:DELay	0 to 65535		
:SLOPe	POSitive NEGative		
:THReshold			
[:ALL]	-2,5 to +2,5 V	V	
:INPut			
:IMPedance	G1K G50 ECL		

[[:SOURce]:DM:STATe ON | OFF

The command switches the digital (user-defined, not stipulated by a standard) modulation on or off.

Example: :SOUR:DM:STAT ON

*RST value is OFF

[[:SOURce]:DM:SEQuence AUTO | RETRigger | AAUTo | ARETrigger | SINGle

This command selects the trigger mode:

AUTO The sequence is repeated cyclically.

RETRigger The sequence is repeated cyclically. After the start, the sequence is restarted with each new trigger even before it is completed.

AAUTo ARMED AUTO. The sequence waits for a trigger signal. After the start, the trigger mode is AUTO and the sequence can't be triggered anymore.

ARETrigger ARMED RETRIGGER. The sequence waits for a trigger signal. After the start, the sequence is restarted with each new trigger even before it is completed.

SINGle After a trigger event, the sequence is only run once.

Example :SOUR:DM:SEQ:REP SING

*RST value is AUTO

[[:SOURce]:DM:SOURce PRBS | PATTern | DLISt | SERial | PARallel | SDATa

The command selects the data source.

PRBS internally generated pseudo random bit sequences.

PATT internally generated (fixed) data pattern.

DLISt internal data generator (only with DGEN).

SERial external serial interface.

PARallel external parallel interface.

SDATa asynchronous serial data input SER DATA.

Example: :SOUR:DM:SOUR SER

*RST value is PRBS

[[:SOURce]:DM:PATTern ZERO | ONE | ALTErnate

The command selects the data pattern. The data range is alternately assigned with 0 and 1 by means of ALTErnate.

Example: :SOUR:DM:PATT ALT

*RST value is ZERO

[[:SOURce]:DM:PRBS[:LENGth] 9 | 15 | 16 | 20 | 21 | 23.

The command determines the length of the pseudo random sequence according to the following equation:

Length = (2^{LENGth}) - 1

Example: :SOUR:DM:PRBS 21

*RST value is 15

[[:SOURce]:DM:DLISt

The commands for the data are under this node. Data lists are not affected by *RST.

[[:SOURce]:DM:DLIS:DATA 0|1 {0|1}...

This command transmits the bit data to the selected data list which is thus overwritten. The data can also be transmitted as block data in binary or PACKed format (see section: Parameter, Block Data). Each byte will then be interpreted as made up of 8 data bits. Here, the command :SYSTem:COMMunicate:GPIB:LTERminator EOI should be used to set the delimiter mode to 'circuit message EOI only' so that an accidental LF within the data sequence is not first identified as a delimiter and thus momentarily interrupts the data transmission. The command ...LTERSTANDARD resets the delimiter mode. The data are not modified by *RST.

Example:

```
:SOUR:DM:DLIS:DATA 0,1,1,0,0,0,0,1,0,1,0,1,1,0,0,0,0,0,1,0,1,1,0,1
:SOUR:DM:DLIS:DATA #13aX-
```

[[:SOURce]:DM:DLIS:DATA? [<start> [<length>]]

The command reads out the data list. If the query is enhanced by the two parameters start and length, the list will be read out in smaller parts. Start and length are given in bits.

Without parameters the whole length will always be output from address 1.

The data format is selected by means of the :FORMat ASCii | PACKed command. The order of the bytes is stipulated in the IEC/IEEE-bus standard (MSbyte first).

Example: :SOUR:DM:DLIS:DATA? 2048,1024

[[:SOURce]:DM:DLIS:DATA:APPend 0|1 {0|1}...

The command allows to transmit the partly very long data lists (up to 20 Mbits = 2.5 Mbyte) in smaller parts. They are added to the end of already existing data.

First, the data list values have to be overwritten using the above DM:DLIS:DATA command. Further data can then be added using the DM:DLIS:DATA:APP commands. The data format is the same for the two commands.

```
Example: :SOUR:DM:DLIS:DATA:APP 0,1,1,0,0,0,0,0,1,0,1,1,0,1,0,0
:SOUR:DM:DLIS:DATA:APP #12aX
```

[[:SOURce]:DM:DLIS:CATalog?

The command returns a list of data list names separated by commas.

Example: :SOUR:DM:DLIS:CAT?

[[:SOURce]:DM:DLIS:SElect '<name>'

The command selects the indicated data list. This list will only take effect as data source with mode :DM:SOURce DLIS selected. The list can only be filled with values if it has been selected beforehand. If the indicated list does not exist, it will be generated. <name> has to be put in brackets (<>) and may have up to 7 characters.

Example: :SOUR:DM:DLIS:SEL 'test'

[[:SOURce]:DM:DLIS:DElete '<name>'

This command deletes the data list indicated by <name>. The name has to be put in brackets (<>) and may have up to 7 alphanumeric characters. This command triggers an event and hence has no *RST value and no query.

Example: :SOUR:DM:DLIS:DEL 'test1'

[[:SOURce]:DM:DLIS:COPIY <name>'

The command copies the selected list to the data list indicated by <name>. This command triggers an event and hence has no *RST value and no query.

Example: :SOUR:DM:DLIS:COPIY 'test1'

[[:SOURce]:DM:DLIS:FREE?

This command returns the available free space for digital data (in bits) and the length of the selected list. The 2 values are separated by a comma.

Example: :SOUR:DM:DLIS:FREE?

[[:SOURce]:DM:DLIS:POINts <n>

The command indicates the number of elements (in bits) of the currently selected data list. Since only multiples of 8 bits can be transmitted when using block data, the exact number of used bits can be set here. Overflow bits in the list are ignored.

Example: :SOUR:DM:DLIS:POIN 234

[[:SOURce]:DM:CLIS

The commands for processing the control list are under this node. The control list contains the switching signals for the burst, the level, the modulation etc. The list index is with reference to the symbols in the data list and the list only contains the status changes. Control lists are not affected by *RST.

[[:SOURce]:DM:CLIS:CONTRol[:STATe] ON | OFF

The command switches control on or off using the control list.

Example: :SOUR:DM:CLIS:CONT ON

*RST value is OFF

[[:SOURce]:DM:CLIS:DATA <struc>{,<struc>}...

The command transmits the bit data to the selected control list which is then overwritten.

struc>=: <symbol-index>, <bin>, <bin>, <bin>, <bin>, <bin>, <bin>

<symbol-index> =: numeric value: 1 to 2²⁶ (67108864)

<bin> =: numeric value: 0 | 1

The data can also be transmitted as a binary block with <struc> being a 4 byte value in which the 26 LSBs represent the symbol index and the remaining 6 bits the binary values (see also section parameter, block data). Each byte is interpreted as made up of 8 data bits. Here, the command :SYSTem:COMMunicate:GPIB:LTERminator EOI should be used to set the delimiter mode to 'circuit message EOI only' so that an accidental LF within the data sequence is not first identified as a delimiter and thus momentarily interrupts the data transmission. The command ...LTER STANdard resets the delimiter mode.

For the query, switchover between the two formats given above is possible by means of the :FORMat ASCii | PACKed command. The order of bytes is stipulated in the IEC/IEEE-bus standard (MSByte first).

It should be noted that in the binary form the symbol index starts with 0. In the binary format this means that each symbol index is less by 1 than actually indicated on the screen and input/output via IEC/IEEE-bus in the ASCII format.

Example:

:SOUR:DM:CLIS:DATA 12345678,0,1,1,0,0,0,23456789,1,0,0,1,0,0

:SOUR:DM:CLIS:DATA #18aX-'y\$?s

The first two positions of the list are filled with the examples (with different values).

[[:SOURce]:DM:CLIS:CATalog?

The command returns a list of data list names separated by commas.

Example: :SOUR:DM:CLIS:CAT?

[[:SOURce]:DM:CLIS:SElect '<name>'

The command selects the indicated control list. This list only becomes effective as control list if the :DM:PRAMP:SOURce CLIS mode has been selected. The list can only be filled with values if it has been selected beforehand. If the indicated list does not exist, it will be generated. <name> has to be put in brackets (< >) and may have up to 7 characters.

Example: :SOUR:DM:CLIS:SEL 'TEST2'

[[:SOURce]:DM:CLIS:DElete '<name>'

The command deletes the control list indicated by <name>. This command triggers an event and hence has no *RST value and no query

Example: :SOUR:DM:CLIS:DEL 'TEST2'

[[:SOURce]:DM:CLIS:COpy '<name>'

The command copies the selected list to the data list indicated by <name>. This command triggers an event and hence has no *RST value and no query.

Example: :SOUR:DM:CLIS:COpy 'TEST2'

[[:SOURce]:DM:CLIS:FREE?

This command returns the available free space for the control data (lines consisting of 4 bytes) in elements.

Example: :SOUR:DM:CLIS:FREE?

[[:SOURce]:DM:CLIS:POINts?

The command returns the number of elements (lines consisting of 4 bytes) of the currently selected list.

Example: :SOUR:DM:CLIS:POIN?

[[:SOURce]:DM:MLIS:DATA A,B,C,D,E,F,I1,Q1,I2,Q2...

The command transmits the mapping data to the selected list which is therefore overwritten. The command can be used only if a list has been selected beforehand (compare with `DM:MLIS:SElect`).

A: 1 for PSK modulation
2 for QAM modulation
3 for FSK modulation

B: 1 to 8, with $B = \log_2 m$ (mapping states)

C: 0 if no delay is to be used in the Q-path
1 if the Q-path is to be delayed by $T_{\text{symbol}}/2$ (e.g. for offset QPSK)

D: 0, reserved

E: 0, reserved

F: 0, reserved

I,Q: Floating point values for I and Q; m values for I and Q must be defined for PSK and QAM modulation. To define FSK all Q-values must be set to 0. The values have to be entered in ascending order starting with the least significant data symbol.

Example (for QPSK with $m = 4$):

```
:SOUR:DM:MLIS:DATA 1,2,0,0,0,0,0.7,0.7,0.7,-0.7,-0.7,0.7,-0.7,-0.7
```

The example results in the following IQ mapping

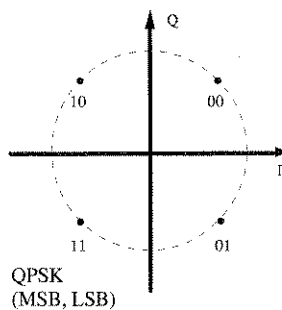

[[:SOURce]:DM:MLIS:CATalog?

The command returns a list of mapping list names separated by commas.

Example: `:SOUR:DM:MLIS:CAT?`

[[:SOURce]:DM:MLIS:SElect '<name>'

The command selects the indicated userdefined mapping list. This list only becomes effective as modulation if the `DM:FORMat USER` mode has been selected. The list can only be filled with values if it has been selected beforehand. If the indicated list does not exist, it will be generated. <name> has to be put in brackets (< >) and may have up to 7 characters.

Example: `:SOUR:DM:MLIS:SEL 'test'`

[[:SOURce]:DM:MLIS:DElete '<name>'

The command deletes the mapping list indicated by <name>. This command triggers an event and hence has no *RST value and no query

Example: `:SOUR:DM:MLIS:DEL 'TEST2'`

[[:SOURce]:DM:MLIS:FREE?

This command returns the available free space for the mapping data (lines consisting of 4 bytes) in elements.

Example: :SOUR:DM:MLIS:FREE?

[[:SOURce]:DM:MLIS:POINTs?

The command returns the number of elements (numbers) of the currently selected list.

Example: :SOUR:DM:MLIS:POIN?

[[:SOURce]:DM:STANdard APCFm | APCQpsk | CDPD | CT2 | DECT | GSM | IRIDium | NADC | PDC | PHS | TETRa | TFTS | PWT | ICOBpsk | ICOGmsk | ICOQpsk

The command adjusts the modulation parameters MODULATION, SYMBOL RATE, FILTER and CODING to the selected standard. The default setting is USER. This setting is always activated automatically if one of the modulation parameters is changed and does not correspond to the selected standard.

APCFm APCO4FM

APCQpsk APCOQPSK

Example: :SOUR:DM:STAN PHS *RST value USER

[[:SOURce]:DM:FORMat BPSK | GFSK | GMSK | QPSK | QIS95 | QINmarsat | QICO | OQPSk | OIS95 | P4Qpsk | P4DQpsk | PSK8 | FSK2 | FSK4 | AFSK4 | QAM16 | QAM32 | QAM64 | QAM256 | USER

The command selects the modulation.

P4DQpsk $\pi/4$ DQSPK

PSK2 is an alias for BPSK

PSK4 is alias for QPSK (according to SCPI).

QIS95 QPSK IS95

OIS95 OQPSK IS95

AFSK4 4FSK APCO

USER The list selected with DM:MLIS:SEL... and defined via DM:MLIS:DATA... is used.

Example: :SOUR:DM:FORM PSK8 *RST value is GMSK

[[:SOURce]:DM:FSK:DEViation 0 to 2.5

The command sets the deviation for FSK (only for DM:FORMat FSK2, FSK4 and GFSK).

Example: :SOUR:DM:FSK:DEV 9 kHz *RST value is 4.5 kHz

[[:SOURce]:DM:SRATe 1kHz to 7 MHz

The command sets the symbol rate.

Example: :SOUR:DM:SRAT 200 kHz *RST value is 24.3 kHz

[[:SOURce]:DM:FILTer

The filter selection commands are under this node.

[[:SOURce]:DM:FILTer:TYPE SCOSine | COSine | GAUSs | BESS1 | BESS2 | IS95 | EIS95 | APCO | TETRa | WCDMa

The command selects the type of filter.

BESS1 BESSEL B*T 1.25

BESS2 BESSEL B*T 2.50

EIS95 IS-95+EQUALIZER

APCO filter according to standard APCO modulation C4FM

Example: :SOUR:DM:FILT:TYPE BESS

*RST value is SCOS

[[:SOURce]:DM:FILTer:PARAmeter 0.1 ... 1.0

The command sets the filter parameter (Roff Off or BxT rate).

Example: :SOUR:DM:FILT:PAR 1

*RST value is 0.35

[[:SOURce]:DM:FILTer:MODE LACP | LEVM

The command selects the filter mode.

Example: :SOUR:DM:FILT:MODE LEVM

*RST value is LACP

[[:SOURce]:DM:CODing OFF | GSM | NADC | PDC | PHS | TETRa | TFTS | PWT | INMarsat | DIFF | DPHS | DGRay | APCO25 | VDL

The command selects the modulation coding (standard) .

DPHS PHASE DIFF

DGRay DIFF + DGRAY

Example: :SOUR:DM:COD NADC

*RST value is OFF

[[:SOURce]:DM:CLOCK

The commands for setting the data clock are under this node.

[[:SOURce]:DM:CLOCK:SOURce INTernal | EXTernal | COUPled

The command selects the source for the clock of the digital modulation.

INTernal The internal clock generator is used.

EXTernal The clock is fed externally.

COUPled The clock comes from the same source as the data. Selection is determined by :DM:SOURce.

Example: :SOUR:DM:CLOC:SOUR INT

*RST value is COUPled

[[:SOURce]:DM:CLOCK:MODE BIT | SYMBol

The command selects the clock mode for :DM:CLOCK:SOURce EXTernal

BIT Only the input D_CLOCK is used.

SYMBol Only the input S_CLOCK is used.

The bit and symbol clock only differ for modulations with more than two states, ie modulations for which more than one bit is required to code each state.

Example: :SOUR:DM:CLOC:MODE BIT

*RST value is SYMBol

[[:SOURce]:DM:CLOCK:DELay 0 to 1.0

The command sets the delay of the symbol clock.

Example: :SOUR:DM:CLOC:DEL 0.2

*RST value is 0

[[:SOURce]:DM:CLOCK:POLarity NORMAL | INVerted

The command selects the active slope for the clock.

NORMAL SLOPE POS.

INVert SLOPE NEG

Example: :SOUR:DM:CLOC:POL INV

*RST value is NORMAL

[[:SOURce]:DM:LDISortion[:STATe] ON | OFF

The command sets the reduced level for the low-distortion mode.

Example: :SOUR:DM:LDIS ON

*RST value is OFF

[[:SOURce]:DM:PRAMP

The commands for the level control of the burst are under this node.

[[:SOURce]:DM:PRAMP[:STATe] ON | OFF

The command switches the level control on or off.

Example: :SOUR:DM:PRAM ON

*RST value is OFF

[[:SOURce]:DM:PRAMP:SOURce CLISt | AEXTernal | DEXTernal

The command selects the level control.

CLISt The control list defined under :DM:CLISt controls the level (INT).

AEXT Analog signal at the burst control input controls the level.

DEXT Digital signals BURSt-GATE and LEV-ATT control the level.

Example: :SOUR:DM:PRAM:SOUR DEXT

*RST value is CLISt

[[:SOURce]:DM:PRAMP:TIME 0.25 to 32

The command sets the steep cutoff (as multiple of symbol length).

Example: :SOUR:DM:PRAM:TIME 2.5

*RST value is 3.0

[[:SOURce]:DM:PRAMP:DELay -1.0 to +5.0

The command defines the shift of the envelope characteristic to the modulated signal. A positive value causes a delay of the envelope.

Example: :SOUR:DM:PRAM:DEL 0.2

*RST value is 0

[[:SOURce]:DM:PRAMP:SHAPE LINear | COSine

The command selects the linear or cosine-square shape of the ramp-up and ramp-down (power burst).

Example: :SOUR:DM:PRAM:SHAP COS

*RST value is COS

[[:SOURce]:DM:PRAMp:ATTenuation 0 to 70 dB

The command sets the level reduction value.

Example: :SOUR:DM:PRAM:ATT 12 dB

*RST value is 0 dB

[[:SOURce]:DM:TRIGger:SOURce EXTernal | INTernal

The command selects the trigger source.

EXT Triggering via external trigger input.

INT Triggering via IEC/IEEE bus or the Execute command of manual control.

Example: :SOUR:DM:TRIG: EXT

*RST value is INTernal

[[:SOURce]:DM:TRIGger:INHibit 0 to 67.1E6

The command sets the retrigger inhibit duration in number of symbols.

Example: :SOUR:DM:TRIG:INH 12000

*RST value is 0

[[:SOURce]:DM:TRIGger:DELay 0 to 65535

The command sets the trigger delay in number of symbols.

Example: :SOUR:DM:TRIG:DEL 10

*RST value is 0

[[:SOURce]:DM:TRIGger:SLOPe POSitive | NEGative

The command selects the active slope of the external trigger signal.

Example: :SOUR:DM:TRIG:SLOP NEG

*RST value is POSitive.

[[:SOURce]:DM:THReshold[:ALL] -2.5 to +2.5V

The command sets the voltage threshold of the digital data and clock inputs.

Example: :SOUR:DM:THR 1 V

*RST value is 1.0 V

[[:SOURce]:DM:INPut:IMPedance G1K | G50 | ECL

The command sets the impedance of all the data and clock inputs:

G1K 1 kOhm to ground

G50 50 Ohm to ground

ECL ECL-compatible input

Example: :SOUR:DM:INP:IMP G50

*RST value is G1K

3.5.11.5 SOURce:FM Subsystem

This subsystem contains the commands to check the frequency modulation and to set the parameters of the modulation signal. The SMIQ can be equipped with two independent frequency modulators (option SM-B5). They are differentiated by a suffix after FM.

SOURce:FM1
SOURce:FM2

Command	Parameter	Default Unit	Remark
[[:SOURce] :FM1 2 [:DEVIation] :EXTernal1 2 :COUPling :INTernal :FREQuency :PREEmphasis :SOURce :STATe	0 to 1MHz AC DC 0.1 Hz to 1 MHz 0 50us 75us INT EXT1 EXT2 ON OFF	Hz Hz	Option SM-B5

[[:SOURce]:FM1|2[:DEVIation] 0 to 1 MHz

The command specifies the frequency variation caused by the FM. Although the LF generator is used as modulation sources, the frequency variation is independent of the voltage at the LF output. The maximally possible DEVIation depends on SOURce:FREQuency (cf. data sheet).

Example: :SOUR:FM1:DEV 5kHz *RST value is 10 kHz

[[:SOURce]:FM1|2:EXTernal1|2

The commands to set the external FM input are under this node. The settings under EXTernal for modulations AM, FM and PM are independent of each other. The settings are always related to the socket which is determined by the numeric suffix after EXTernal. The suffix after FM is ignored then. With the following commands, e.g., the settings are both related to EXT2 input:

```
:SOUR:FM1:EXT2:COUP AC
:SOUR:FM2:EXT2:COUP AC
```

A command without suffix is interpreted like a command with suffix 1.

[[:SOURce]:FM1|2:EXTernal1|2:COUPling AC | DC

The command selects the type of coupling for the external FM input.

AC The d.c. voltage content is separated from the modulation signal.

DC The modulation signal is not altered.

*RST value is AC

Example: :SOUR:FM:EXT:COUP AC

[[:SOURce]:FM1|2:INTernal

The settings for the internal FM generators are effected under this node. For FM1, this is always the internal LF generator. Here the same hardware is set for FM1, PM1, AM:INT as well as SOURce2. For FM2, only the external sources can be used (not the internal LF generator).

This means that, e.g., the following commands are coupled with each other and have the same effect:

SOUR:AM:INT:FREQ

SOUR:FM:INT:FREQ

SOUR:PM:INT:FREQ

SOUR2:FREQ:CW

[[:SOURce]:FM1|2:INTernal:FREQuency 0.1 Hz to 1 MHz

The command sets the modulation frequency.

Example: :SOUR:FM:INT:FREQ 10kHz

*RST value is 1 kHz

[[:SOURce]:FM1|2:PREEmphasis 0 | 50us | 75us

The command selects the preemphasis

0 No preemphasis

50 us 50 μ s, European standard 50 μ s

75 us 75 μ s, American standard 75 μ s

*RST value is 0

Example: :SOUR:FM:PRE 50us

[[:SOURce]:FM1|2:SOURce INTernal | EXTernal1 | EXTernal2

The command selects the modulation source. A command without suffix is interpreted like a command with suffix 1. The LF generator is INT for FM1. The external and the internal modulation source can be indicated at the same time (see example)

Example: :SOUR:FM:SOUR INT1, EXT2

*RST value for FM1: INT
for FM2:EXT2

[[:SOURce]:FM1|2:STATe ON | OFF

The command switches the frequency modulation on or off.

Example: SOUR:FM:STAT OFF

*RST value is OFF.

3.5.11.6 SOURce:FREQUENCY Subsystem

This subsystem contains the commands for the frequency settings of the RF source including the sweeps.

Command	Parameter	Default Unit	Remark
[[:SOURce]			
:FREQUency			SMIQ03
:CENTer	300 kHz to 2.2 GHz	Hz	300 kHz to 3.3 GHz
[[:CW :FIXed]	300 kHz to 2.2 GHz	Hz	300 kHz to 3.3 GHz
:RCL	INCLude EXCLude		
:MANual	300 kHz to 2.2 GHz	Hz	300 kHz to 3.3 GHz
:MODE	CW FIXed SWEep LIST		
:OFFSet	-50 to +50 GHz	Hz	
:SPAN	0 to 2.2 GHz	Hz	0 to 3.3 GHz
:START	300 kHz to 2.2 GHz	Hz	300 kHz to 3.3 GHz
:STOP	300 kHz to 2.2 GHz	Hz	300 kHz to 3.3 GHz
:STEP		Hz	
[[:INCRement]	0 to 1 GHz		

[[:SOURce]:FREQUency:CENTer 300 kHz to 2.2 GHz (SMIQ03 300 kHz to 3.3 GHz)

The command sets the sweep range by means of the center frequency. This command is coupled to commands :SOURce:FREQUency:START and :SOURce:FREQUency:STOP.

In this command, value OFFSet is considered as with input value FREQUENCY in the FREQUENCY menu. Thus the specified range indicated is only valid for OFFSet = 0. The specified range with other OFFSet values can be calculated according to the following formula (cf. Chapter 2, Section "Frequency Offset" as well):

$$300 \text{ kHz} + \text{OFFSet} \text{ to } 2.2 \text{ GHz} + \text{OFFSet} \quad \text{*RST value is } (\text{START} + \text{STOP})/2$$

Example: :SOUR:FREQ:CENT 100kHz

[[:SOURce]:FREQUency[:CW]:FIXed] 300 kHz to 2.2 GHz (SMIQ03: 300 kHz to 3.3 GHz)

The command sets the frequency for CW operation. This value is coupled to the current sweep frequency. In addition to a numeric value, UP and DOWN can be indicated. The frequency is increased or reduced by the value set under :SOURce:FREQUency:STEP. (As to specified range, cf. FREQUency:CENTer).

Example: :SOUR:FREQ:CW 100kHz *RST value is 100 MHz

[[:SOURce]:FREQUency[:CW]:FIXed]:RCL INCLude | EXCLude

The command determines the effect of the recall function on the frequency. *RST value has no effect to this setting.

INCLude The saved frequency is loaded when instrument settings are loaded with the [RECALL] key or with a memory sequence.

EXCLude The RF frequency is not loaded when instrument settings are loaded, the current settings are maintained.

Example: :SOUR:FREQ:RCL INCL

[:SOURce]:FREQuency:MANual 300 kHz to 2.2 GHz (SMIQ03: 300 kHz to 3.3 GHz)

The command sets the frequency if `SOURce:SWEep:MODE` `MANual` and `SOURce:FREQuency:MODE` `SWEep` are set. Only frequency values between the settings with `:SOURce:FREQuency:START` and `:SOURce:FREQuency:STOP` are permitted. (As to specified range, cf. `FREQuency:CENTer`) *RST value is 100 MHz

Example: `:SOUR:FREQ:MAN 500MHz`

[:SOURce]:FREQuency:MODE CW | FIXed | SWEep | LIST

The command specifies the operating mode and hence also specifies which commands check the `FREQuency` subsystem. The following allocations are valid

CW | FIXed CW and FIXed are synonyms. The output frequency is specified by means of `:SOURce:FREQuency:CW | FIXed`.

SWEep The instrument operates in the `SWEep` operating mode. The frequency is specified by means of commands `SOURce:FREQuency:START`; `STOP`; `CENTer`; `SPAN`; `MANual`.

LIST The instrument processes a list of frequency and level settings. The settings are effected in the `SOURce:LIST` subsystem. Setting `SOURce:FREQuency:MODE` `LIST` automatically sets command `SOURce:POWER:MODE` to `LIST` as well.

Example: `:SOUR:FREQ:MODE SWE` *RST value is CW.

[:SOURce]:FREQuency:OFFSet -50 to + 50 GHz

The command sets the frequency offset of an instrument which might be series-connected, e.g. a mixer. (cf. Chapter 2, Section "Frequency Offset"). If a frequency offset is entered, the frequency entered using `SOURce:FREQuency:to` does no longer correspond to the RF output frequency. The following connection is true:

$SOURce:FREQuency:to = \text{RF output frequency} + SOURce:FREQuency:OFFSet.$

Entering an offset does not alter the RF output frequency but the query value of `SOURce:FREQuency:..`

Example: `:SOUR:FREQ:OFFS 100MHz` *RST value is 0

[:SOURce]:FREQuency:SPAN 0 to 2.2 GHz (SMIQ03: 0 kHz to 3.3 GHz)

This command indicates the frequency range for the sweep. This parameter is coupled to the start and stop frequency. Negative values for `SPAN` are permitted, then `STARTt > STOP` is true. There is the following connection:

`STARTt` = `CENTer` - `SPAN/2`

`STOP` = `CENTer` + `SPAN/2`

*RST value is (STOP - START)

Example: `:SOUR:FREQ:SPAN 1GHz`

[:SOURce]:FREQuency:STARt 300 kHz to 2.2 GHz (SMIQ03: 300 kHz to 3.3 GHz)

This command indicates the starting value of the frequency for the sweep operation. Parameters `STARt`, `STOP`, `SPAN` and `CENTer` are coupled to each other. `STARt` may be larger than `STOP`. (As to specified range, cf. `FREQuency:CENTer`). *RST value is 100MHz

Example: `:SOUR:FREQ:STAR 1MHz`

[[:SOURce]:FREQuency:STOP 300 kHz to 2.2 GHz (SMIQ03: 300 kHz to 3.3 GHz)

This command indicates the final value of the frequency for the sweep operation (see START as well). (As to specified range, cf. FREQuency:CENTer). *RST value is 500MHz

Example: :SOUR:FREQ:STOP 100MHz

[[:SOURce]:FREQuency:STEP

The command to enter the step width for the frequency setting if frequency values UP or DOWN are used is under this node. This command is coupled to the KNOB STEP command in manual control. Only linear step widths can be set.

[[:SOURce]:FREQuency:STEP[:INCRement] 0 to 1 GHz

The command sets the step width for the frequency setting.

Example: :SOUR:FREQ:STEP:INCR 1MHz

*RST value is 1MHz

3.5.11.7 SOURce:FSIM -Subsystem

The FSIM system comprises the commands for the fading simulator (options SMIQ-B14 and SMIQB15).

Command	Parameter	Default Unit	Remark
[[:SOURce]			
:FSIMulator			Option SMIQB14
[:STATe]	ON OFF		
:CONFig	S6Path S12Path D6Path		S12P and D6P only with option SMIQB15
:SEquence	RUN STOP		
:RESet			
:STANdard	CDMA8 CDMA30 CDMA100 NADC8 NADC50 NADC100 GTU3 G6TU3 GTU50 G6TU50 GHT100 G6HT100 GRA250 GET50 GET100 PTU1 P6TU1 PTU50 P6TU50 PHT100 P6HT100 PRA130 PET50 PET100 TTU THT TET		
:SPEed			
:UNIT	MPS KMPH MPH		
:PATH<i>	<i> = 1 to 6 (12)		7 to 12 only with SMIQB15
:STATe	ON OFF		
:PROFile	PDOPpler RAYLeigh RICE		
:DCOMponent			
:STATe	ON OFF		
:PRATio	-30.0 to +30.0 dB	dB	
:FRATio	-1.0 to +1.0		
:SPEed	0.005 to 27 777 MPS		depending on FSIM:SPE:UNIT
:FDOPpler	0.1 to 1600.0 Hz	Hz	
:LOSS	0 to 50.0 dB	dB	
:DELay	0 to 1638.0E-6	s	
:CORRelation			
:PATH	0 7 to 12		
:COEFFicient	0 to 1.0		
:PHASe	0 to 359	DEG	
:LOGNormal			
:STATe	ON OFF		
:LCONstant	1 to 99 999		
:CSTD	0 to 12.0	dB	

[[:SOURce]:FSIMulator[:STATe] ON | OFF

Switches the fading simulator on or off.

*RST value: OFF

Example: :SOUR:FSIM ON

[[:SOURce]:FSIMulator:CONFig S6Path | S12Path | D6Path

Defines the number of active paths and channels. S12Path and D6Path are only possible with option SMIQ-B15.

S6Path Single channel, 6 active paths

S12Path Single channel, 12 active paths

D6Path Dual channel, 6 active paths

Example: :SOUR:FSIM:CONF S6P *RST value: S6P/S12P (without/with option SMIQB15)

[[:SOURce]:FSIMulator:SEQuence RUN | STOP

This command starts (RUN) or stops (STOP) the Pseudo Noise Generator for generating the fading process.

*RST value: STOP

Example: :SOUR:FSIM:SEQ RUN

[[:SOURce]:FSIMulator:SEQuence:RESet

This command resets the pseudo random sequence for the fading to its original value. FSIMulator:SEQuence is set to STOP (and has to be restarted with RUN). Since this command triggers an event it has no *RST value.

Example: :SOUR:FSIM:SEQ:RES

[[:SOURce]:FSIMulator:STANdard CDMA8 | CDMA30 |

Selects the fading standard. All subsequent FSIM commands are set to a predefined value. The parameters with a '6' as second character select the 6-path mode (this mode must be set if option SMIQB15, Second Fading Generator is not available).

CDMA8, CDMA30, CDMA100

NADC8, NADC50, NADC100

GTU3, G6TU2, GTU50, G6TU50

GHT100, G6HT100

GRA250

GET50, GET100

PTU1, P6TU1, PTU50, P6TU50

PHT100, P6HT100

PRA130

PET50, PET100

TTU

THT

TET

GSM Typical Urban

GSM Hilly Terrain

GSM Rural Area

GSM Equal Test

DCS1800/PCS1900 Typical Urban

DCS1800/PCS1900 Hilly Terrain

DCS1800/PCS1900 Rural Area

DCS1800/PCS1900 Equal Test

Tetra Typical Urban

Tetra Hilly Terrain,

Tetra Equal Test

Example: :SOUR:FSIM:STAN NADC50

*RST value: CDMA8

[[:SOURce]:FSIMulator:SPEed:UNIT MPS | KMPH | MPH

This command selects the speed unit.

MPS m/s, meter per second
 KMPH km/h, kilometer per hour
 MPH miles per hour

Example: :SOUR:FSIM:SPE:UNIT MPH

*RST value: MPS

[[:SOURce]:FSIMulator:ILOSs:MODE NORMAl | LACP

This command sets the insertion loss of the fading simulator.

NORMAl The insertion loss is fixed to 18 dB, which is ideal for BER measurements.
 LACP The insertion loss is between 12 and 14 dB to obtain a better S/N ratio, for instance during adjacent-channel measurements.

Example: :SOUR:FSIM:ILOS:MODE LACP

*RST value is NORMAl

[[:SOURce]:FSIMulator:POWER?

This command returns the total average power of all the paths at the RF output.

Example: :SOUR:FSIM:POW?

[[:SOURce]:FSIMulator:DEFault

This command selects the default setting of the path parameters. Path 1 is switched on; all other paths are switched off. This command triggers an event and hence has no *RST value and no query.

Example: :SOUR:FSIM:DEF

[[:SOURce]:FSIMulator:PATH<i>

The following commands can be separately set for each path. The path is selected with the suffix <i>; <i> being assigned a value from 1 to 6 (one fading simulator) or 1 to 12 (two fading simulators).

[[:SOURce]:FSIMulator:PATH<i>:STATE ON | OFF

This command switches the selected path on or off.

Example: :SOUR:FSIM:PATH3:STAT ON

*RST value: OFF

[[:SOURce]:FSIMulator:PATH<i>:PROFile PDOPpler | RAYLeigh | RICE

This command assigns a fading profile (scattering image) to the selected path.

PDOPpler pure doppler profile.
 RAYLeigh standard Rayleigh profile
 RICE standard Rice profile

Example: :SOUR:FSIM:PATH3:PROF RICE

*RST value: RAYL

[[:SOURce]:FSIMulator:PATH<i>:DCOMponent:STATe ON | OFF

This command switches the discrete components on or off.

*RST value: OFF

Example: :SOUR:FSIM:PATH3:CCOM:STAT ON

[[:SOURce]:FSIMulator:PATH<i>:PRATio -30 to +30 dB

This command sets the power ratio (for RICE profile only). The resolution is 0.1 dB.

Example: :SOUR:FSIM:PATH3:PRAT -20

*RST value: 0

[[:SOURce]:FSIMulator:PATH<i>:FRATio -1.0 to +1.0

The command sets the frequency ratio (for RICE profile only). The resolution is 0.1.

Example: :SOUR:FSIM:PATH3:FRAT 0.5

*RST value: 1

[[:SOURce]:FSIMulator:PATH<i>:SPEed 0.005 to 27 777 (in MPS (m/s))

This command sets the vehicle speed. The unit is defined separately with the command FSIM:SPEed:UNIT.

Example: :SOUR:FSIM:PATH3:SPE 10.0

*RST value: 20 MPS

[[:SOURce]:FSIMulator:PATH<i>:FDOPpler 0.1 to 1600 Hz

This command specifies the Doppler frequency (coupled to the vehicle speed). The resolution is 0.1 Hz.

Example: :SOUR:FSIM:PATH3:FDOP 100

*RST value: 6.7

[[:SOURce]:FSIMulator:PATH<i>:LOSS 0 to 50.0 dB

This command sets the path loss. The resolution is 0.1 dB.

*RST value: 0

Example: :SOUR:FSIM:PATH3:LOSS 20

[[:SOURce]:FSIMulator:PATH<i>:DELay 0 to 1638.0E-6

This command sets the signal delay in the path. The resolution is 50 ns.

*RST value: 0

Example: :SOUR:FSIM:PATH3:DEL 123E-6

[[:SOURce]:FSIMulator:PATH<i>:CORRelation

This node provides the commands for setting the correlation to another path (only with option SMIQB15).

[[:SOURce]:FSIMulator:PATH<i>:CORRelation:PATH 0 | 7 to 12

This command defines the correlating path 7 to 12 for path <n>. If no correlation exists, 0 is selected.

Example: :SOUR:FSIM:PATH3:CORR:PATH 12

*RST value: 0

[[:SOURce]:FSIMulator:PATH<i>:CORRelation:COEFFicient 0 to 1.0

This command sets the correlation coefficient. The resolution is 0.05.

*RST value: 1

Example: :SOUR:FSIM:PATH3:CORR:COEF 0.3

[[:SOURce]:FSIMulator:PATH<i>:CORRelation:PHASe 0 to 359 degree

This command sets the correlation phase. The resolution is 1 degree.

*RST value: 0

Example: :SOUR:FSIM:PATH3:CORR:PHAS 180

[[:SOURce]:FSIMulator:PATH<i>:LOGNormal

This node provides the commands for setting the lognormal fading.

[[:SOURce]:FSIMulator:PATH<i>:LOGNormal:STATe ON | OFF

This command switches lognormal fading on or off.

*RST value: OFF

Example: :SOUR:FSIM:PATH3:LOGN:STAT OFF

[[:SOURce]:FSIMulator:PATH<i>:LOGNormal:LCONstant 1 to 99 999

This command enters the local constant in meters. The unit is not a component of this command. The resolution is 0.1 m.

*RST value: 200

Example: :SOUR:FSIM:PATH3:LOGN:LCON 50

[[:SOURce]:FSIMulator:PATH<i>:LOGNormal:CSTD 0 to 12.0 dB

This command sets the standard deviation of lognormal fading. The resolution is 1 dB.

Example: :SOUR:FSIM:PATH3:LOGN:CSTD 2.0

*RST value: 0

3.5.11.8 SOURce:GSM Subsystem (Digital Standard)

Note: #B0 to #B1 are characters which are entered in binary form manually. SCPI (and IEEE 488.2) also accept the entry of non-numeric characters in octal and hex such as #H|h <0 to 9, A|a to F|f>, #Q|q <0 to 7> and #B|b <0|1>. The characters are always output in binary format after a query.

Command	Parameter	Default unit	Remark
[[:SOURce]]			
:GSM			
:STATe	ON OFF		
:STANdard			no query
:FORMat	GMSK GFSK		
:FSK			
:DEViation	1kHz to 300 kHz	Hz	
:SRATe	1kHz to 300 kHz	Hz	
:FILTer			
:PARAmeter	0.2 to 0.7		
:SEQuence	AUTO RETRigger AAUTO ARETrigger		
:TRIGger			
:SOURce	EXTernal INTernal		
:INHibit	0 to 67.1E6		
:DELay	0 to 65535		
:OUTPut[2]			
:DELay	0 to 1249		
:PERiod	1 to 67.1E6		
:CLOCK			
:SOURce	INTernal EXTernal		
:DELay	0 to 1.0		
:PRAMP			
:PRESet			no query
:TIME	0.25 to 16		
:SHAPE	LINear COSine		
:DELay	-1.0 to +1.0		
:ROFFset	-9 to +9		
:FOFFset	-9 to +9		
:SLOT			
:ATTenuation	0 to 70 dB	dB	

Command	Parameter	Default unit	Remark
[[:SOURCE]]			
:GSM			
:FLIST			
:PREDEFINED			
:CATALOG?			query only
:LOAD	'name'		
:CATALOG?			query only
:LOAD	'name'		
:STORE	'name'		no query
:DELETE	'name'		no query
:DLIST			
:CATALOG?			query only
:SLOT<i>			i=0,[1],2 to 7 (Slot Selector)
:TYPE	NORMAL DUMMY ADATA		
:LEVEL	OFF ATT FULL		
:PRESET			
:HOPPING			
:TRIGGER	ON OFF		
:SOURCE	PN9 PN11 PN15 PN 16 PN20 PN21 PN23 DLIST SDATA		
:DATA	'name'		
:DLIST	0 1		
:SF			
:TSC	T0 to T7 USER		
:SELECT	#B0 to #B1111 to (26 bits)		
:USER			

[[:SOURCE]]:GSM:STATE ON | OFF

The command switches the modulation on according to GSM standard. All other standards that might be switched on or digital modulation are automatically switched OFF.

Example: : SOUR : GSM : STAT ON

*RST value is OFF

[[:SOURCE]]:GSM:STANDARD

The command sets all modulation parameters to the values of the GSM standard. I.e., all values that have been selected by the :GSM:SLOT... commands described in the following are not valid. This command triggers an event and hence has no *RST value and no query.

Example: : SOUR : GSM : STAN

[:SOURCE]:GSM:FORMat GMSK | GFSK

This command selects the modulation type.

Example: :SOUR:GSM:FORM GFSK

*RST value is GMSK

[:SOURCE]:GSM:FSK:DEVIation 1kHz to 300 kHz

This command sets the deviation for GSM:FORMat GFSK. The range of values depends on the symbol rate (GSM:SRATe).

Example: :SOUR:GSM:FSK:DEV 37.6kHz

*RST value is 67.708 kHz

[:SOURCE]:GSM:SRATe 1kHz to 300 kHz

The command sets the symbol rate.

Example: :SOUR:GSM:SRAT 270.9 kHz

*RST value is 270.833 kHz

[:SOURCE]:GSM:FILTer:PARAmeter 0.2 to 0.7

The command sets the filter parameter.

Example: :SOUR:GSM:FILT:PAR 0.4

*RST value is 0.3

[:SOURCE]:GSM:SEQuence AUTO | RETRigger | AAUTo | ARETrigger

The command selects the trigger mode for the sequence.

AAUTo is ARMED AUTO

ARETrigger is ARMED RETRIG

Example: :SOUR:GSM:SEQ AAUT

*RST value is AUTO

[:SOURCE]:GSM:TRIGger:SOURce EXTernal | INTernal

The command selects the trigger source. With INT selected, triggering is via IEC/IEEE bus or the Execute command in manual control.

Example: :SOUR:GSM:TRIG:SOUR EXT

*RST value is INT

[:SOURCE]:GSM:TRIGger:INHibit 0 to 67.1E6

The command sets the retrigger inhibit duration (in number of symbols).

Example: :SOUR:GSM:TRIG:INH 1000

*RST value is 0

[:SOURCE]:GSM:TRIGger:DELay 0 to 65535

The command sets the trigger delay (in number of symbols).

Example: :SOUR:GSM:TRIG:DEL 200

*RST value is 0

[:SOURCE]:GSM:TRIGgerOUTPut[2]:DELay 0 to 1249

The command determines the delay of the signal at trigger output 2 in comparison with the start of the frames in number of symbols.

Example: :SOUR:GSM:TRIG:OUTP2:DEL 16

*RST value is 0

[[:SOURce]:GSM:TRIGger:OUTPut[2]:PERiod 1 to 67.1E6

The command sets the repeat rate (in number of frames) of the signal at trigger output 2.

Example: :SOUR:GSM:TRIG:OUTP:PER 8 *RST value is 1

[[:SOURce]:GSM:CLOCK

The commands for setting the data clock are under this node.

[[:SOURce]:GSM:CLOCK:SOURce INTERNAL | EXTERNAL

The command selects the source for the DM data clock.

INTERNAL The internal clock generator is used and output via the clock outputs of the serial and parallel interface.

EXTERNAL The clock is externally fed in via the serial interface and output via the parallel interface.

Example: :SOUR:GSM:CLOC:SOUR INT *RST value is INT

[[:SOURce]:GSM:CLOCK:DELay 0 to 1.0

The command sets the delay of the symbol clock (as a fraction of the length of a symbol).

Example: :SOUR:GSM:CLOC:DEL 0.75 *RST value is 0

[[:SOURce]:GSM:PRAMP

The commands for the level control of the burst are under this node.

[[:SOURce]:GSM:PRAMP:PRESet

This command sets the standard-stipulated values for the following commands of level control. It is an event and hence has no query and no *RST value.

Example: :SOUR:GSM:PRAM:PRES

[[:SOURce]:GSM:PRAMP:TIME 0.25 to 16.0

The command sets the cutoff steepness (in symbol clocks).

Example: :SOUR:GSM:PRAM:TIME 2.5 *RST value is 3

[[:SOURce]:GSM:PRAMP:DELay -1.0 to + 1.0

The command defines the shift of the envelope characteristic to the modulated signal. A positive value causes a delay of the envelope.

Example: :SOUR:GSM:PRAM:DEL 0.2 *RST value is 0

[[:SOURce]:GSM:PRAMP:SHAPE LINear | COSine

The command selects the linear or cosine shape of the ramp-up and ramp-down (power burst).

Example: :SOUR:GSM:PRAM:SHAP COS *RST value is COS

[[:SOURCE]:GSM:PRAMP:ROFFset -9 to +9

The command determines the timing of the ('R'ising) edge of a power burst to the beginning of the block.

Example: :SOUR:GSM:PRAM:ROFF -3 *RST value is 0

[[:SOURCE]:GSM:PRAMP:FOFFset -9 to +9

The command determines the timing of the ('E'alling) edge of a power burst to the data block

Example: :SOUR:GSM:PRAM:FOFF 4 *RST value is 0

[[:SOURCE]:GSM:SLOT:ATTenuation 0 to -70 dB

The command determines the amount by which the power of the slots marked by :GSM:SLOT:LEVEL ATT is reduced in comparison with the normal output power (Attribut to :LEVEL FULL).

Example: :SOUR:GSM:SLOT:ATT 20 dB *RST value is 0

[[:SOURCE]:GSM:FLIST

The commands for storing and reading complete frames including their bursts (slots) are under this node. Predefined and user-generated frames have to be distinguished.

[[:SOURCE]:GSM:FLIST:PREDefined:CATalog?

The command returns a list of all predefined frames.

Example: :SOUR:GSM:FLIS:PRED:CAT?

[[:SOURCE]:GSM:FLIST[:PREDefined]:LOAD 'name'

The command selects one of the predefined (fixed) frames (c.f. Chapter 2). This command triggers an event and hence has no *RST value.

Example: :SOUR:GSM:FLIS:PRED:LOAD 'NB0'

[[:SOURCE]:GSM:FLIST:CATalog?

The command returns a list of all user-defined frames.

Example: :SOUR:GSM:FLIS:CAT?

[[:SOURCE]:GSM:FLIST:LOAD 'name'

The command loads a user-defined frame. This command triggers an event and hence has no *RST value.

Example: :SOUR:GSM:FLIS:LOAD 'test'

[[:SOURCE]:GSM:FLIST:STORE 'name'

The command stores the current frame under a name. This command triggers an event and hence has no *RST value.

Example: :SOUR:GSM:FLIS:STOR 'test'

[[:SOURCE]:GSM:FLIST:DELETE 'name']

The command deletes the indicated frame. This command triggers an event and hence has no *RST value and no query.

Example: :SOUR:GSM:FLIS:DEL 'test1'

[[:SOURCE]:GSM:DLIST:CATALOG?]

The command returns an enumeration of all data lists.

These data lists are selected by means of :GSM:SLOT:SOUR:DATA 'name' and used if :GSM:SLOT:SOUR:DATA DLIST is set.

Example: :SOUR:GSM:DLIS:CAT?

[[:SOURCE]:GSM:SLOT<i>]

The commands for setting the slot characteristics are under this node. Since a frame contains 8 slots, suffix 'i' is used to select the slot to be changed. i = 0 | [1] | 2 | 3 | 3 | 5 | 6 | 7

[[:SOURCE]:GSM:SLOT<i>:TYPE NORM | DUMMY | ADATA]

The command selects the type of burst (slot) defined in the standard.

ADATa is All Data

Example: :SOUR:GSM:SLOT2:TYPE DUMM

*RST value is NORM

[[:SOURCE]:GSM:SLOT<i>:LEVEL OFF | ATT | FULL]

The command determines the power stage of the slot.

OFF The slot is inactive

ATT The power is reduced by the amount defined by :GSM:SLOT:ATT

FULL Full power (predefined by level setting)

Example: :SOUR:GSM:SLOT2:LEV ATT

Slot 0: *RST value is FULL

Slot 1 to 7: *RST value is OFF

[[:SOURCE]:GSM:SLOT<i>:PRESET]

The command sets all the parameters of the slot to the values defined by the standard as a function of the type set above. This command triggers an event and hence has no *RST value and no query.

Example: :SOUR:GSM:SLOT2:PRES

[[:SOURCE]:GSM:SLOT<i>:HOPPING:TRIGGER ON | OFF]

This command provides a trigger signal at the PARData connector (ON). This signal can be used to perform frequency hopping in the LIST MODE.

Example: :SOUR:GSM:SLOT2:HOPP:TRIG ON

*RST value is OFF

[[:SOURCE]:GSM:SLOT<i>:SOURCE:DATA PN9 | PN15 | PN16 | PN20 | PN21 | PN23 | DLIST | SDATa]

The command determines the data source for the data words (for :SLOT:TYPE NORM and ADATa)

Example: :SOUR:GSM:SLOT2:SOUR:DATA PN15

*RST value is PN9

[[:SOURce]:GSM:SLOT<i>:SOURce:DATA:DLIS 'name'

The command selects a data list. This list will not be used unless it is set as a data source by means of the :GSM:SLOT:SOUR:DATA:DLIS command. This command triggers an event and hence has no *RST value.

Example: :GSM:SLOT:SOUR:DATA:DLIS 'test'

[[:SOURce]:GSM:SLOT<i>:SF 0 | 1

This command sets the stealing flag (GSM:SLOT:TYPE NORM only)

Example: :SOUR:GSM:SLOT2:SFR:STAT ON

*RST value is OFF

[[:SOURce]:GSM:SLOT<i>:TSC:SELEct T0 to T7 | USER

This commands selects the training sequence code. 0 to 7 are the BCC values stipulated by GSM 5.02. With USER selected as parameter, the given value described with the following ...:TSC:USER command will be used.

Example: :GSM:SLOT:TSC:SEL 3

*RST value is 0

[[:SOURce]:GSM:SLOT<i>:TSC:USER #B0 to #B1111... (26 bits)

The TSC value is determined by the user by means of this command. TSC will be used if the parameter (!) USER is set by means of the above-mentioned :GSM:SLOT:TSC command.

Example: :GSM:SLOT:TSC:USER #B01101100110011100011111100

*RST value is 111111111

3.5.11.9 SOURce:IS95 Subsystem (Digital Standard IS-95/CDMA)

Command	Parameter	Default unit	Remark
[:SOURce]			
:IS95			
:STATe	ON OFF		
:MODE	FLINK18 FLINK64 RLINK		
:PRESet			
:CRATe	1kHz to 7 MHz	Hz	
:FILTer			
:FTYPE	SCOSine COSine IS95 EIS95		
:RTYPE	SCOSine COSine IS95 EIS95		
:PARAmeter	0.1 to 0.7		
:MODE	LACP LEVM		
:LDISortion			
[:STATe]	ON OFF		
:SEQuence	AUTO RETRigger AAUTO ARETrigger		
:TRIGger			
:SOURce	EXTernal INTernal		
:INHibit	0 to 67108863		
:DELAy	0 to 65535		
:OUTPut[1] 2	TFRame SSRollover SFRame ESECond		
:POLarity	POSitive NEGative		
:CLOCK			
:MODE	CHIP CHIP4 CHIP8 CHIP16		
:SOURce	INTernal EXTernal		
:DELAy	-32768 to 32768		
:POWER?			query only
:ADJust	-		
:MAPPING			
:PREDefined			
:CATalog?	⇒ name {,name}		query only
:SELEct	'name'		
:CATalog?	⇒ name {,name}		query only
:LOAD	'name'		No query
:STORE	'name'		No query
:DELeTe	'name'		No query
:CHANnel<0..63>		dB	
:WALShcode	0 to 63		
:POWER	-30 dB to 0 dB		
:DATA	ZERO ONE ALTErnate PRBS		
:STATe	ON OFF		
:RATE	FULL HALF		
:RANDomizer			
[:STATe]	ON OFF		
:DATA	ZERO ONE ALTErnate PRBS		

Command	Parameter	Default unit	Remark
[:SOURce]			
:IS95			
:DLISt	'name'		
:CATalog?	⇒ name {,name}...		query only
:RLCoded			
:CTYPe	TRAF14400 TRAF7200 TRAF3600 TRAF1800 ACC4800 TRAF9600 TRAF4800 TRAF2400 TRAF1200		
:DATA	PN9 PN11 PN15 PN 16 PN20 PN21 PN23 DLISt		
:DLISt	'name'		
:FQINdicator	ON OFF		
:CENCoder	ON OFF		
:BINTerleaver	ON OFF		
:EBIT	0 1		

[:SOURce]:IS95:STATe ON | OFF

The command switches the modulation on according to the IS95 standard which is a CDMA method. All other standards or digital modulation that might be switched on are automatically switched off (OFF).

Example: `:SOUR:IS95:STAT ON`

*RST value is OFF

[:SOURce]:IS95:MODE FLINK18 | FLINK64 | RLINk | RLCoded

The command selects the operating mode.

FLINK18 Forward Link with 18 code channels

FLINK64 Forward Link with 64 code channels

RLINk Reverse Link (from mobile station to base station)

RLCoded Reverse Link Coded

Example: `:SOUR:IS95:MODE RLIN`

[:SOURce]:IS95:PRESet

The command sets all the following settings into a defined default state (as with to *RST). It can thus be guaranteed that a signal is generated at all and that it is in line with standard. This command triggers an event and hence has no *RST value and no query.

Example: `:SOUR:IS95:MAPP:PRESet`

[:SOURce]:IS95:CRATe 1 kHz to 7 MHz

The command sets the chip rate.

Example: `:SOUR:IS95:CRAT 1.21 MHz`

*RST value is 1.2288 MHz

[[:SOURCE]:IS95:FILTer

The commands for selecting a filter are under this node.

[[:SOURCE]:IS95:FILTer:FTYPE SCOSine | COSine | IS95 | EIS95

The command selects the type of filter for the Forward Link Mode (IS95:FLINK18 or IS95:FLINK64).

SCOSine Square root cosine (root Nyquist) filter

COSine Cosine (Nyquist)-filter

IS95 Filter according to Interim Standard 95

EIS95 IS-95+EQUALIZER

Example: :SOUR:IS95:FILT:FTYP COS

*RST value is EIS95

[[:SOURCE]:IS95:FILTer:RTYPE SCOSine | COSine | IS95 | EIS95

The command selects the type of filter for the Reverse Link Mode.

SCOSine Square root cosine (root Nyquist) filter

COSine Cosine (Nyquist)-filter

IS95 Filter according to Interim Standard 95

EIS95 IS-95+EQUALIZER

Example: :SOUR:IS95:FILT:RTYP COS

*RST value is EIS95

[[:SOURCE]:IS95:FILTer:PARAmeter 0.1 to 0.7

The command sets the roll-off factor for the COS filters.

Example: :SOUR:IS95:FILT:PAR 0.5

*RST value is 0.5

[[:SOURCE]:IS95:FILTer:MODE LACP | LEVM

This command selects one of the "L"ow filter modes.

Example: :SOUR:IS95:FILT:MODE LEVM

*RST value is LACP

[[:SOURCE]:IS95:LDISortion[:STATe] ON | OFF

The command sets the reduced level for the low-distortion mode.

ON Low-distortion mode

OFF Normal level

Example: :SOUR:IS95:LDIS ON

*RST value is OFF

[.:SOURce]:IS95:SEQuence AUTO | RETRigger | AAUTo | ARETrigger

The command selects the trigger mode for the sequence..

AUTOContinuously repeated

RETRigger Continuously repeated; new start after a trigger

AAUTo ARMED AUTO; waits for trigger, then switches over to AUTO and can no longer be triggered;

ARETrigger ARMED RETRIG; a trigger event is required to start, each new trigger causes a restart

Example: :SOUR:IS95:SEQ AAUT *RST value is AUTO

[.:SOURce]:IS95:TRIGger:SOURce EXTernal | INTernal

The command selects the trigger source. With INT selected, triggering is via remote control using the trigger command or via EXECUTE TRIGGER in case of manual control.

EXT The trigger signal is fed in via input TRIGIN

INT A start is only possible manually or via the remote control command TRIG:DM:IMM

Example: :SOUR:IS95:TRIG:SOUR EXT *RST value is INTI

[.:SOURce]:IS95:TRIGger:INHibit 0 to 67108863

The command sets the retrigger inhibit duration (in number of chips).

Example: :SOUR:IS95:TRIG:INH 1000 *RST value is 0

[.:SOURce]:IS95:TRIGger:DELAy 0 to 65535

The command defines the trigger delay (in number of chips).

Example: :SOUR:IS95:TRIG:DEL 200 *RST value is 0

[.:SOURce]:IS95:TRIGger:OUTPut[1]2 TFRame | SSRollover | SFRame | ESECond | GATE

The command defines the output signal at trigger output 1 or 2. The following times can be selected:

TFRame Traffic Frame/ 20 ms

SSRollover Short Sequence Rollover 80/3 ms

SFRame Super Frame 80 ms

ESECond Even Second 2 s

GATE

The indicated times apply to a chip rate of 1.2288 Mcps

Example: :SOUR:IS95:TRIG:OUTP1 SFR output1: *RST value is ESECond
output2: *RST value is SSRollover

[.:SOURce]:IS95:TRIGger:OUTPut[1]2:DELAy -32768 to 32768

The command defines the delay of trigger signals in IC.

Example: :SOUR:IS95:TRIG:OUTP2:DEL -50 *RST value is 0

[[:SOURce]:IS95:TRIGger:OUTPut[1]2:POLarity POSitive | NEGative

The commands defines the polarity of the signals at the trigger outputs.

Example: :SOUR:IS95:TRIG:OUTP2:POL NEG

*RST value is POS

[[:SOURce]:IS95:CLOCK

The commands for setting the chip clock are under this node.

[[:SOURce]:IS95:CLOCK:MODE CHIP | CHIP4 | CHIP8 | CHIP16

The command sets the divider for the clock. With CHIP selected, the external clock is in the symbol mode, otherwise in the bit mode.

Example: :SOUR:IS95:CLOC:MODE CHIP8

*RST value is CHIP

[[:SOURce]:IS95:CLOCK:SOURce INTernal | EXTernal

The command selects the clock source.

INTernal The internal clock generator is used and output via clock outputs SYMBOL CLOCK and BIT CLOCK.

EXTernal The clock is fed externally via connector SYMBOL CLOCK.

Example: :SOUR:IS95:CLOC:SOUR EXT

*RST value is INT

[[:SOURce]:IS95:CLOCK:DELay 0 to 1.00

The command sets the delay of the chip clock with a high resolution.

Example: :SOUR:IS95:CLOC:DEL 0.75

*RST value is 0

[[:SOURce]:IS95:POWER?

The command queries the total power for the CDMA signal.

Example: :SOUR:IS95:POW?

[[:SOURce]:IS95:POWER:ADJust

The command modifies the power of each active code channel. This means that the total power is set equal to the power in the level display. The command triggers an action and hence has no *RST value assigned.

Example: :SOUR:IS95:POW:ADJ

[[:SOURce]:IS95:MAPPING

The command for storing and reading the complete channel assignments and settings are under this node. These mappings are not affected by *RST.

[[:SOURce]:IS95:MAPPING:PREDefined:CATalog?

The command returns a list of all predefined mappings.

Example: :SOUR:IS95:MAPP:PRED:CAT?

[[:SOURce]:IS95:MAPPING[:PREDefined]:LOAD 'name'"]

The command selects one of the predefined channel configurations (c.f. Chapter 2). This command triggers an event and hence has no *RST value.

Example: `:SOUR:IS95:MAPP:SEL 'PILOT'`

[[:SOURce]:IS95:MAPPING:CATalog?]

The command returns an enumerated list of all user-defined mappings.

Example: `:SOUR:IS95:MAPP:CAT?` Answer: 'test1', 'test2'

[[:SOURce]:IS95:MAPPING:LOAD 'name']

The command loads a user-defined channel assignment and setting (mapping). The name may have a maximum of 7 characters. This command triggers an action and hence has no *RST value.

Example: `:SOUR:IS95:MAPP:LOAD 'test'`

[[:SOURce]:IS95:MAPPING:STORE 'name']

The command stores the current mapping under a name. The name may have a maximum of 7 characters. This command triggers an action and hence has no *RST value and no query.

Example: `:SOUR:IS95:MAPP:STOR 'test'`

[[:SOURce]:IS95:MAPPING:DELETE 'name']

The command deletes the indicated mapping. This command triggers an action and hence has no *RST value and no query.

Example: `:SOUR:IS95:MAPP:DEL 'test1'`

[[:SOURce]:IS95:CHANNEL<0 to 63>]

The commands for specifying the channel configuration for the 18-channel Forward Link (channel 0 to 17) and 64-channel Forward Link (channel 0 to 63) are under this node. Channel 0 for which only the power can be set is the pilot channel.

[[:SOURce]:IS95:CHANNEL<1 to 17>:WALShcode 0 to 63]

This command assigns a Walsh code to a channel. This applies to FLINK18 only; for FLINK64, the Walsh code corresponding to its channel number is assigned to every channel. The command is not available in this case.

Example: `:SOUR:IS95:CHAN2:WALS 23`

[[:SOURce]:IS95:CHANNEL<0 to 3>:POWER -30 dB to 0 dB]

This command determines the power of a channel. For Flink18 the power for channels 0, 1 and 2 can be set separately. The power setting for channel 3 is also valid for the subsequent channels. For Flink64 the power setting for channel 1 is valid for all subsequent channels (except for the pilot channel)

Example: `:SOUR:IS95:CHAN2:POW -22 DB`

[[:SOURce]:IS95:CHANnel<1 to 63>:DATA ZERO | ONE | ALternate | PRBS

This command determines the data source of the channel.

ZERO0000..., sequence of zeros

ONE 1111..., sequence of ones

ALT 1010..., alternating sequence, starting with 1

PRBS Pseudo Random Bit sequence

Example: :SOUR:IS95:CHAN2:DATA PRBS

[[:SOURce]:IS95:CHANnel<0 to 63>:STATe ON | OFF

The command switches the channel on or off.

Flink18: channels 0 to 8 are switched on and channels 9 to 17 are switched off.

Flink64: all channels are switched on.

Example: :SOUR:IS95:CHAN17:STAT ON

*RST value: see text

[[:SOURce]:IS95:RATE FULL | HALF

The command sets the data rate for operating mode Reverse Link (IS95:MODE RLINK).

Example: :SOUR:IS95:RATE HALF

*RST value is FULL

[[:SOURce]:IS95:RANDomizer[:STATe] ON | OFF

The command switches the burst randomizer for operating mode Reverse Link (IS95:MODE RLINK) on or off. The bursts are distributed at pseudo random within a 20-ms frame.

Example: :SOUR:IS95:RAND ON

*RST value is OFF

[[:SOURce]:IS95:DATA ZERO | ONE | ALternate | PRBS | DLIS

This command determines the data source for operating mode Reverse Link (IS95:MODE RLINK).

ZERO0000..., sequence of zeros

ONE 1111..., sequence of ones

ALT 1010..., alternating sequence, starting with 1

PRBS Pseudo Random Bit Sequence

DLIS The data list selected with IS95:DLIS 'name' is used.

Example: :SOUR:IS95:DATA ZERO

*RST value is PRBS

[[:SOURce]:IS95:DLIS 'name'

The command selects a data list. This list is used if DLIS is selected as the data source (IS95:DATA DLIS).

Example: :SOUR:IS95:DLIS 'test'

[[:SOURce]:IS95:DLIS:CATalog?

The command queries the available data lists. (Only query, no *RST value)

Example: :SOUR:IS95:DLIS:CAT?

[:SOURce]:IS95:RLCoded:CTYPe TRAF14400 | TRAF7200 | TRAF3600 | TRAF1800 | ACC4800 | TRAF9600 | TRAF4800 | TRAF2400 | TRAF1200

The command defines the data rate and the channel type. It is only available with `IS95:MODE RLCoded` selected.

Example: : SOUR: IS95: RLC: CTYP TRAF1800 *RST value is TRAF14400

[:SOURce]:IS95:RLCoded:DATA PN9 | PN11 | PN15 | PN 16 | PN20 | PN21 | PN23 | DLIS

The command selects the data source. PN.. represent the PRBS generators, DLIS the data list selected with the following command. The command is only available with `IS95:MODE RLCoded` selected.

Example: : SOUR: IS95: RLC: DATA DLIS *RST value is PN9

[:SOURce]:IS95:RLCoded:DLIS 'name'

The command selects a data list. This list is used if DLIS is selected as the data source. The command is only available with `IS95:MODE RLCoded` selected.

Example: : SOUR: IS95: RLC: DLIS 'test'

[:SOURce]:IS95:RLCoded:FQINdicator ON | OFF

The command switches the frame quality indicator (a CRC of the data) on or off. If the frame quality indicator is switched off, only zeros are transmitted. The command is only available with `IS95:MODE RLCoded` selected.

Example: : SOUR: IS95: RLC: FQIN OFF *RST value is ON

[:SOURce]:IS95:RLCoded:CENCoder ON | OFF

The command switches the convolutional encoder on or off. If the convolutional encoder is off, the required data rate is attained by repeating the symbols. The command is only available with `IS95:MODE RLCoded` selected.

Example: : SOUR: IS95: RLC: CENC OFF *RST value is ON

[:SOURce]:IS95:RLCoded:BINTerleaver ON | OFF

The command selects the block interleaver function. It is only available with `IS95:MODE RLCoded` selected.

Example: : SOUR: IS95: RLC: BINT OFF *RST value is ON

[:SOURce]:IS95:RLCoded:EBIT 0 | 1

The command sets the value of the erasure bit. It is only available with `IS95:MODE RLCoded` selected.

Example: : SOUR: IS95: RLC: EBIT 0 *RST value is 1

3.5.11.10 SOURce:LIST Subsystem

This subsystem contains the commands for the LIST operating mode of the RF generator. Processing the lists is controlled by the TRIGger:LIST subsystem. Each list consists of a FREQuency, POWer and DWELI content. The list contents must all be of the same length except for contents of length 1. This is interpreted as if the content had the same length as the other contents and all values were equal to the first value. After a list has been created and changed, command :LIST:LEARn has to be entered to have the settings transferred to the hardware.

The LIST mode is activated by command SOURce:FREQuency:MODE LIST.

Note: SCPI designates the individual lists as segments.

Command	Parameter	Default unit	Remark
[:SOURce] :LIST			
:CATalog?			Query only
:DELeTe	'Name of list'		
:ALL			
:DWELI	1ms to 1 s {, 1 ms to 1 s}	s	Query only
:POINts?			Query only
:FREE?			
:FREQuency	300 kHz to 2.2GHz {, 300 kHz to 2.2GHz} block data	Hz	SMIQ03: to 3.3 GHz Query only
:POINts?			No query
:LEARn			
:MODE	AUTO STEP		
:POWer	-144 to 16 dBm {, -144 to 16 dBm} block data	dBm	
:POINts?			Query only
:SELEct	'Name of list'		

[:SOURce]:LIST:CATalog?

The command requests a list of the lists available separated by commas. The command is a query and hence has no *RST value.

Example: :SOUR:LIST:CAT?

Answer: 'MYLIST', 'LIST1', 'LIST2'

[:SOURce]:LIST:DELeTe 'Name of list'

The command deletes the list indicated. *RST has no influence on data lists.

Example: :SOUR:LIST:DEL 'LIST2'

[:SOURce]:LIST:DELeTe:ALL

The command deletes all lists. As a possibly selected list is deleted as well, the LIST mode must be switched off (SOURce:FREQuency:MODE CW or SWEep). *RST has no influence on data lists.

Example: :SOUR:LIST:DEL:ALL

[[:SOURce]:LIST:DWELI 1 ms to 1 s {, 1 ms to 1 s}

For every item of the FREQUency or POWer/VOLTage list contents, the command contains the time the instrument 'dwells' at this item.

Note: *The RF generator is not in a position to allocate different times to the individual items of the FREQUency and POWer list contents. Thus the DWELI part of the list should have length 1; the value is then valid for all items. If a list containing more than one element is indicated, all values must be equal.*

Example: :SOUR:LIST:DWEL 0.15

[[:SOURce]:LIST:DWELI:POINTs?

The command queries the length (in items) of the DWELI-part of the list. The command is a query and thus has no *RST value.

Example: :SOUR:LIST:DWEL:POIN? Answer: 1

[[:SOURce]:LIST:FREE?

The command queries two values. The first one indicates the space still vacant for lists (in items), the second one the space already occupied, also in items. The command is a query and thus has no *RST value.

Example: :SOUR:LIST:FREE? Answer: 2400, 200

[[:SOURce]:LIST:FREQUency 300 kHz to 2.2 GHz {, 300 kHz to 2.2 GHz}| block data
(SMIQ03: 300 kHz to 3.3 GHz)

The command fills the FREQUency part of the list selected with data. The data can either be indicated as a list of numbers (separated by commas) of arbitrary length or as binary block data. In the case of block data transmission, always 8 (4) bytes are interpreted as a floating-point number of double accuracy (cf. command FORMat :DATA). *RST does not influence data lists.

Example: :SOUR:LIST:FREQ 1.4GHz, 1.3GHz, 1.2GHz, ...

[[:SOURce]:LIST:FREQUency:POINTs?

The command queries the length (in items) of the FREQUency part of the list presently selected. The command is a query and thus has no *RST value.

Example: :SOUR:LIST:FREQ:POIN? Answer: 327

[[:SOURce]:LIST:LEARn

The command learns the list selected. I.e., it determines the hardware setting for the entire list. The data thus determined are stored together with the list. The command triggers an event and thus has no *RST value.

Example: :SOUR:LIST:LEAR

Caution: *This command has to be given after every creating and changing of a list. The list must be learned as well after temperature changes or after calling internal calibration routines, as all parameters usually controlled are replaced by stored values in the LIST mode.*

[[:SOURce]:LIST:MODE AUTO | STEP

The command indicates the mode in which the list is to be processed (by analogy with SOURce:SWEEP:MODE).

AUTO Each trigger event triggers a complete list run.

STEP Each trigger event triggers only one step in processing the list.

Example: :SOUR:LIST:MODE STEP *RST value is AUTO

[[:SOURce]:LIST:POWER -144 to 16 dBm {, -144 to 16 dBm} | block data

The command fills the LEVEL part of the RF list selected with data. The data can either be indicated as a list of numbers (separated by commas) of arbitrary length or as binary block data. As to the format of the data, cf. command :SOURce:LIST:FREQ. *RST does not influence data lists.

Example: :SOUR:LIST:POW 0dBm, -2dBm, -2dBm, -3dBm, ...

[[:SOURce]:LIST:POWER:POINTS?

The command queries the length (in items) of the LEVEL part of the list presently selected. The command is a query and thus has no *RST value

Example: :SOUR:LIST:POW:POIN? Answer: 32

[[:SOURce]:LIST:SElect 'Name of list

The command selects the list indicated. If there is no list of this name, a new list is created. The name may contain up to 7 letters. The command triggers an event and thus has no *RST value

Example: :SOUR:LIST:SEL 'LIST1'

3.5.11.11 SOURce:MARKer Subsystem

This subsystem contains the commands to check the marker generation with sweeps. The SMIQ has three markers each for frequency and level sweeps which are differentiated by a numeric suffix after MARKer. The settings for frequency sweep and level sweep marker are independent of each other.

Command	Parameter	Default Unit	Remark
[:SOURce] :MARKer1 2 3 [:FSWweep] :AMPLitude :AOFF :FREQuency [:STATe] :PSweep :AOFF :POWer [:STATe] :POLarity	ON OFF 300 kHz to 2.2 GHz ON OFF -144 to+16 dBm ON OFF NORMal INVerted	Hz dBm	No query SMIQ03 300 kHz to 3.3 GHz No query

[:SOURce]:MARKer1|2|3[:FSWweep]

The commands for the markers with frequency sweep are under this node. Keyword :FSWweep can be omitted, then the command conforms to SCPI regulations.

[:SOURce]:MARKer1|2|3[:FSWweep]:AMPLitude ON | OFF

The command specifies whether the marker influences the signal level.

ON The output level is reduced by a constant value when the marker frequency is executed.

OFF The output level remains unchanged. *RST value is OFF

Example: :SOUR:MARK1:FSW:AMP ON

[:SOURce]:MARKer1|2|3[:FSWweep]:AOFF

Command (All markers off) switches off all frequency markers. This command triggers an event, thus it has no *RST value and no query form.

Example: :SOUR:MARK:FSW:AOFF

[:SOURce]:MARKer1|2|3[:FSWweep]:FREQuency 300 kHz to 2.2 GHz (SMIQ03: 300 kHz to 3.3 GHz)

The command sets the marker selected by the numeric suffix with MARKer to the frequency indicated.

In this command, the OFFSet value of the subsystem (menu) FREQuency is considered as with input value MARKer in the SWEEP-FREQ menu. Thus the specified range indicated is only valid for SOURce:FREQuency:OFFSet = 0. The specified range with other OFFSet values can be calculated according to the following formula (cf. Chapter 2, Section "Frequency Offset", as well):

300 kHz - OFFSet to 2.2/3.3 GHz - OFFSet *RST value for MARK1: 100 MHz
MARK2: 200 MHz
MARK3: 300 MHz

Example: :SOUR:MARK1:FSW:FREQ 30MHz

[[:SOURCE]:MARKer1|2|3[:FSweep][:STATe] ON | OFF

The command switches the marker selected by the numeric suffix with MARKer on or off.

Example: :SOUR:MARK1:FSW:STAT ON *RST value is OFF

[[:SOURCE]:MARKer1|2|3:PSweep

The commands for the markers with level sweep are under this node (Power sweep). The three markers are differentiated by a numeric suffix after MARKer.

[[:SOURCE]:MARKer1|2|3:PSweep:AOff

The command switches all level markers off. This command is an event and thus has no *RST value and no query form.

Example: :SOUR:MARK:PSW:AOff

[[:SOURCE]:MARKer1|2|3:PSweep:POWer -144 dBm to +16 dBm

The command sets the marker selected by the numeric suffix with MARKer to the level indicated.

In this command, the OFFSet value of subsystem (menu) POWER (LEVEL) is considered in correspondence with input value MARKer in the SWEEP LEVEL menu. Thus the specified range indicated is only valid for SOURCE:POWer:OFFSet = 0. The specified range with other OFFSet values can be calculated according to the following formula (cf. Chapter 2, Section "Level Offset" as well):

-144 dBm OFFSet to 16 dBm OFFSet *RST value for MARK1: 1 dBm

MARK2: 2 dBm

MARK3: 3 dBm

Example: :SOUR:MARK1:PSW:POW -2dBm

[[:SOURCE]:MARKer1|2|3:PSweep[:STATe] ON | OFF

The command switches the marker selected by the numeric suffix with MARKer on or off.

Example: :SOUR:MARK1:PSW:STAT ON *RST value is OFF

[[:SOURCE]:MARKer1|2|3:POLarity NORMal | INVerted

The command specifies the polarity of the marker signal.

NORMal When running through the marker condition, TTL level is applied at the marker output, otherwise 0 V.

INVerted When running through the marker condition, 0 V is applied at the marker output, otherwise TTL level. *RST value is NORM

Example: :SOUR:MARK:POL INV

3.5.11.12 SOURce:NADC Subsystem (Digital Standard)

Note #H0 to #HF are characters which are entered in alphanumeric Hex form manually. SCPI (and IEEE 488.2) also accept the entry of non-decimal characters in octal and binary such as
 #H|h <0 to 9, A|a to F|f>,
 #Q|q <0 to 7> and
 #B|b <0|1>.
 The characters are always output in Hex format after a query.

Command	Parameter	Default unit	Remark
[:SOURce]			
:NADC			
:STATe	ON OFF		
:STANdard	-		No query
:SRATe	1kHz to 200 kHz	Hz	
:FILTer			
:TYPE	SCOSine COSine		
:PARAmeter	0.1 to 0.7		
:MODE	LACP LEVM		
:LDISortion			
[:STATe]	ON OFF		
:SEQuence	AUTO RETRigger AAUTO ARETrigger		
:TRIGger			
:SOURce	EXTernal INTernal		
:INHibit	0 to 67.1E6		
:DELay	0 to 65535		
:OUTPut[2]			
:DELay	0 to 971		
:PERiod	1 to 67.1E6		
:CLOCK			
:SOURce	INTernal EXTernal		
:MODE	BIT SYMBol		
:DELay	0 to 1.0		
:PRAMp			
:PRESet			no query
:TIME	0.25 to 16		
:SHAPE	LINear COSine		
:ROFFset	-9 to +9		
:FOFFset	-9 to +9		
:LINK	UP DOWN		
:RCONfiguration	AHALf FULL1 FULL2 FULL3 FULL12 FULL13 FULL23 AFULI		

Command	Parameter	Default unit	Remark
[:SOURce]			
:NADC			
:FLISt			
:PREDeFined			
:CATalog?	⇒ name {,name}...		query only
:LOAD	'name'		
:CATalog?	⇒ name {,name}...		query only
:LOAD	'name'		
:STORe	'name'		no query
:DELete	'name'		no query
:DLISt			
:CATalog?	⇒ name {,name}...		query only
:SLOT<i>		dB	i=[1],2 to 8 (Slot Selector)
:ATTenuation	0 to 70 dB		
:TYPE	TCH SHORt ADATa		
:LEVel	OFF ATT FULL		no query
:PRESet	-		
:SOURce			
:SACChannel	PN9 PN11 PN15 PN 16 PN20 PN21 PN23 DLISt SDATa		
:DLISt	'name'		
:DATA	PN9 PN11 PN15 PN 16 PN20 PN21 PN23 DLISt SDATa		
:DLISt	'name'		
:SYNC	#H0 to #HFFFFFF (28 bit)		
:CDVCC	#H1 to #HFFF (8 bit)		
:RSVD	#H800 to #HFFF (12/11 bit)		

[:SOURce]:NADC:STATe ON | OFF

The command switches the modulation on according to NADC standard. All other standards that might be switched on or digital modulation are automatically switched OFF.

Example: : SOUR : NADC : STAT ON

*RST value is OFF

[:SOURce]:NADC:STANdard

The commands sets all modulation parameters to the values of the NADC standard. I.e., all values that have been selected by the :NADC:SLOT... commands described in the following are not valid. This command triggers an event and hence has no *RST value and no query.

Example: : SOUR : NADC : STAN

[[:SOURce]:NADC:SRATe 1kHz to 200 kHz

The command sets the symbol rate.

Example: :SOUR:NADC:SRAT 192.1 kHz

*RST value is 192 kHz

[[:SOURce]:NADC:FILTer

The commands for selecting a filter are under this node.

[[:SOURce]:NADC:FILTer:TYPE SCOSine|COSine

The command selects the type of filter.

Example: :SOUR:NADC:FILT:TYPE COS

*RST value is SCOS

[[:SOURce]:NADC:FILTer:PARAmeter 0.1 to 0.7

The command sets the filter parameter entry (Roll Off factor).

Example: :SOUR:NADC:FILT:PAR 0.5

*RST value is 0.35

[[:SOURce]:NADC:FILTer:MODE LACP | LEVM

This command selects one of the "L"ow filter modes.

Example: :SOUR:NADC:FILT:MODE LEVM

*RST value is LACP

[[:SOURce]:NADC:LDISortion[:STATe] ON | OFF

The command sets the reduced level for the low-distortion mode.

Example: :SOUR:NADC:LDIS ON

*RST value is OFF

[[:SOURce]:NADC:SEQuence AUTO | RETRigger | AAUTo | ARETrigger

The command selects the trigger mode for the sequence.

AAUTo is ARMED AUTO

ARETrigger is ARMED RETRIG

Example: :SOUR:NADC:SEQ AAUT

*RST value is AUTO

[[:SOURce]:NADC:TRIGger:SOURce EXTernal | INTernal

The command selects the trigger source. With INT selected, triggering is via IEC/IEEE bus or the Execute command in manual control.

Example: :SOUR:NADC:TRIG:SOUR EXT

*RST value is INT

[[:SOURce]:NADC:TRIGger:INHibit 0 to 67.1E6

The command sets the retrigger inhibit duration (in number of symbols).

Example: :SOUR:NADC:TRIG:INH 1000

*RST value is 0

[[:SOURce]:NADC:TRIGger:DELay 0 to 65535

The command sets the trigger delay (in number of symbols).

Example: :SOUR:NADC:TRIG:DEL 200

*RST value is 0

[[:SOURce]:NADC:TRIGgerOUTPut[2]:DELay 0 to 971

The command determines the delay of the signal at trigger output 2 in comparison with the start of the frames in number of symbols.

Example: :SOUR:NADC:TRIG:OUTP2:DEL 16

*RST value is 0

[[:SOURce]:NADC:TRIGger:OUTPut[2]:PERiod 1 to 67.1E6

The command sets the repeat rate (in number of frames) of the signal at trigger output 2.

Example: :SOUR:NADC:TRIG:OUTP:PER 8

*RST value is 1

[[:SOURce]:NADC:CLOCK

The commands for setting the data clock are under this node.

[[:SOURce]:NADC:CLOCK:SOURce INTernal | EXTernal

The command selects the source for the DM data clock.

INTernal The internal clock generator is used and output via the clock outputs of the serial and parallel interface.

EXTernal The clock is externally fed in via the serial interface and output via the parallel interface.

Example: :SOUR:NADC:CLOC:SOUR INT

*RST value is INT

[[:SOURce]:NADC:CLOCK:MODE BIT | SYMBol

The command sets the clock mode for :NADC:CLOCK:SOURce EXTernal.

BIT The external clock has to be a bit clock.

SYMBol The external clock has to be a symbol clock.

The bit and symbol clock only differ for this modulation, because it has more than two states, ie more than one bit is required to code each state.

Example: :SOUR:NADC:CLOC:MODE BIT

*RST value is SYMB

[[:SOURce]:NADC:CLOCK:DELay 0 to 1.0

The command sets the delay of the symbol clock (as a fraction of the length of a symbol).

Example: :SOUR:NADC:CLOC:DEL 0.75

*RST value is 0

[[:SOURce]:NADC:PRAMP

The commands for the level control of the burst are under this node.

[[:SOURce]:NADC:PRAMP:PRESet

This command sets the standard-stipulated values for the following commands of level control. It is an event and hence has no query and no *RST value.

Example: :SOUR:NADC:PRAM:PREs

[[:SOURce]:NADC:PRAMP:TIME 0.25 to 16.0

The command sets the cutoff steepness (in symbol clocks).

Example: :SOUR:NADC:PRAM:TIME 2.5 *RST value is 3

[[:SOURce]:NADC:PRAMP:DELay -1.0 to + 1.0

The command defines the shift of the envelope characteristic to the modulated signal. A positive value causes a delay of the envelope.

Example: :SOUR:NADC:PRAM:DEL 0.2 *RST value is 0

[[:SOURce]:NADC:PRAMP:SHAPe LINear | COSine

The command selects the linear or cosine shape of the ramp-up and ramp-down (power burst).

Example: :SOUR:NADC:PRAM:SHAP COS *RST value is COS

[[:SOURce]:NADC:PRAMP:ROFFset -9 to +9

The command determines the timing of the ('R'ising) edge of a power burst to the beginning of the block.

Example: :SOUR:NADC:PRAM:ROFF -3 *RST value is 0

[[:SOURce]:NADC:PRAMP:FOFFset -9 to +9

The command determines the timing of the ('F'alling) edge of a power burst to the data block

Example: :SOUR:NADC:PRAM:FOFF 4 *RST value is 0

[[:SOURce]:NADC:LINK UP | DOWN

The command determines the burst type which differs depending on the transmit direction. The structure of the frames is different and thus has an effect on the selection of possible :NADC:SLOT commands. This command is stored as a part of the :NADC:FLIST configurations described below.

UP From mobile part to fixed part

DOWN From fixed part to mobile part

Example: :SOUR:NADC:LINK DOWN *RST value is DOWN

[[:SOURce]:NADC:RCONfiguration AHAlf | FULL1 | FULL2 | FULL3 | FULL12 | FULL13 | FULL23 | AFUL

This configuration setup determines how the FULL- and HALF-rate channels (slots) are distributed among the frames. This command is stored as a part of the :NADC:FLISt configurations described below.

AHALf	All Half
FULL1	FULL (1 & 4)
FULL2	FULL (2 & 5)
FULL3	FULL (3 & 6)
FULL12	FULL (1 & 4), (2 & 5)
FULL13	FULL (1 & 3), (3 & 6)
FULL23	FULL (2 & 5), (3 & 6)
AFUL	All Full

Example: :SOUR:NADC:RCON FULL3

*RST value is AFUL

[[:SOURce]:NADC:FLISt

The commands for storing and reading complete frames including their bursts (slots) are under this node. Predefined and user-generated frames have to be distinguished.

[[:SOURce]:NADC:FLISt:PREDefined:CATalog?

The command returns a list of all predefined frames.

Example: :SOUR:NADC:FLIS:PRED:CAT?

[[:SOURce]:NADC:FLIS[:PREDefined]:LOAD 'name'

The command selects one of the predefined (fixed) frames (c.f. Chapter 2). This command triggers an event and hence has no *RST value and no query.

Example: :SOUR:NADC:FLIS:PRED:LOAD 'test'

[[:SOURce]:NADC:FLIS:CATalog? =>name, {name}...

The command returns a list of all user-defined frames.

Example: :SOUR:NADC:FLIS:CAT?

[[:SOURce]:NADC:FLIS:LOAD 'name'

The command loads a user-defined frame. This command triggers an event and hence has no *RST value and no query.

Example: :SOUR:NADC:FLIS:LOAD 'dn_tch'

[[:SOURce]:NADC:FLIS:STORE 'name'

The command stores the current frame under a name. This command triggers an event and hence has no *RST value and no query.

Example: :SOUR:NADC:FLIS:STOR 'test'

[[:SOURce]:NADC:FLIS:DELe] 'name'

The command deletes the indicated frame. This command triggers an event and hence has no *RST value and no query.

Example: :SOUR:NADC:FLIS:DEL 'test1'

[[:SOURce]:NADC:DLIS:CATalog?]

The command returns an enumeration of all data lists.

These data lists are selected by means of :NADC:SLOT:SOUR:SACC:DLIS 'name' and ...:DATA:DLIS 'name' and used if :NADC:SLOT:SOUR:SACC DLIS and ...:DATA DLIS are set.

Example: :SOUR:NADC:DLIS:CAT?

[[:SOURce]:NADC:SLOT<i>]

The commands for setting the slot characteristics are under this node. Since a frame contains 6 slots, suffix 'i' is used to select the slot to be changed. i = [1] | 2 | 3 | 3 | 5 | 6

[[:SOURce]:NADC:SLOT:ATTenuation 0 to -70 dB]

The command determines the amount by which the power of the slots marked by :NADC:SLOT:LEVEL ATT is reduced in comparison with the normal output power (Attribut to :LEVEL FULL).

Example: :SOUR:NADC:SLOT:ATT 20 dB *RST value is 0

[[:SOURce]:NADC:SLOT<i>:TYPE TCH | SHORt | ADATa]

The command selects the type of burst (slot) defined in the standard.

TCH Normal communication channel with the fields defined by the standard.

ADATa All data (without predefined SYNC, SACCh, CDVCC and RSVD fields)

SHORt Only used for uplink to set up TCH.

Example: :SOUR:NADC:SLOT2:TYPE TCH *RST value is TCH

[[:SOURce]:NADC:SLOT<i>:LEVe] OFF | ATT | FULL]

The command determines the power stage of the slot.

OFF The slot is inactive.

For UPLINK, the source is always at full power. Therefore, in the case of an DOWNLINK TCH burst, only a series of 1's is sent instead of the data.

ATT The power is reduced by the amount defined by :NADC:SLOT:ATT
For an DOWNLINK TCH burst this setting is not valid.

FULL Full power (predefined by level setting)

Example: :SOUR:NADC:SLOT2:LEV ATT *RST value is FULL

[[:SOURce]:NADC:SLOT<i>:PRESet]

The command sets all the parameters of the slot to the values defined by the standard as a function of the type set above and the direction (LINK). This command triggers an event and hence has no *RST value and no query.

Example: :SOUR:NADC:SLOT2:PRES

[[:SOURce]:NADC:SLOT<i>]:SOURce

The commands for determining the source for the data contents are under this node. The source is either a PRBS generator (with different sequence length), the data input SER DATA or a data list.

Selection of data source for the data fields of the burst:

PN9 to 23 PRBS generator has been selected
 DLIS Data of a programmable data list
 SDATa Data from data input SER DATA

[[:SOURce]:NADC:SLOT<i>]:SOURce:SACChannel PN9 | PN11 | PN15 | PN16 | PN20 | PN21 | PN23 | DLIS | SDATa

The command determines the data source for the data words.

Example: :NADC:SLOT3:SOUR:SACC PN15 *RST value is PN9

[[:SOURce]:NADC:SLOT<i>]:SOURce:SACChannel:DLIS 'name'

The command selects a data list. This list will not be used unless it is set as a data source by means of the :NADC:SLOT:SOUR:SACC DLIS command. This command triggers an event and hence has no *RST value.

Example: :NADC:SLOT:SOUR:SACC:DLIS 'test'

[[:SOURce]:NADC:SLOT<i>]:SOURce:DATA PN9 | PN11 | PN15 | PN16 | PN20 | PN21 | PN23 | DLIS | SDATa

The command determines the data source for the data words.

Example: :SOUR:NADC:SLOT2:SOUR:DATA DLIS *RST value is PN9

[[:SOURce]:NADC:SLOT<i>]:SOURce:DATA:DLIS 'name'

The command selects a data list. This list will not be used unless it is set as a data source by means of the :NADC:SLOT:SOUR:DATA DLIS command. This command triggers an event and hence has no *RST value.

Example: :NADC:SLOT:SOUR:DATA:DLIS 'test'

[[:SOURce]:NADC:SLOT<i>]:SYNC #H0 to #FFFFFFF (28 bit)

The command changes the sync word predefined by the standard.

Example: :SOUR:NADC:SLOT2:SYNC #HC7E3C0C *RST value depends on SLOT:TYPE

[[:SOURce]:NADC:SLOT<i>]:CDVCC #H1 to #HFFF (8 bit)

This command sets the Coded Digital Verification Color Code.

Example: :SOUR:NADC:SLOT2:CDVCC #H3F *RST value is 1

[[:SOURce]:NADC:SLOT<i>]:RSVD #H800 to #HFFF (12/11 bit)

The command sets the reserved word (only for TCH and LINK DOWN). The MSBit is normally set.

Example: :SOUR:NADC:SLOT2:RSVD #H80F *RST value is #H800

3.5.11.13 SOURce:PDC Subsystem (Digital Standard)

Note: #H0 to #HF are characters which are entered in alphanumeric Hex form manually. SCPI (and IEEE 488.2) also accept the entry of non-numeric characters in octal and binary such as #H|h <0 to 9, A|a to F|f>, #Q|q <0 to 7> and #B|b <0|1>. The characters are always output in Hex format after a query.

Command	Parameter	Default unit	Remark
[:SOURce]			
:PDC			
:STATe	ON OFF		
:STANdard			No query
:SRATe	1kHz to 200 kHz	Hz	
:FILTer			
:TYPE	SCOSine COSine		
:PARAmeter	0.1 to 0.7		
:MODE	LACP LEVM		
:LDISortion			
[:STATe]	ON OFF		
:SEQuence	AUTO RETRigger AAUTo ARETrigger		
:TRIGger			
:SOURce	EXTernal INTernal		
:INHibit	0 to 67.1E6		
:DELay	0 to 65535		
:OUTPut[2]			
:DELay	0 to 839		
:PERiod	1 to 67.1E6		
:CLOCK			
:SOURce	INTernal EXTernal		
:MODE	BIT SYMBol		
:DELay	0 to 1.0		
:PRAMp			no query
:PRES			
:TIME	0.25 to 16		
:SHAPE	LINear COSine		
:ROFFset	-9 to +9		
:FOFFset	-9 to +9		
:SLOT			
:ATTenuation	0 to 70 dB	dB	
:LINK	UP DOWN		
:RCONfiguration	AHALf FULL0 FULL1 FULL2 FULL10 FULL20 FULL21 AFUL		

Command	Parameter	Default unit	Remark
[:SOURCE]			
:PDC			
:FLISt			
:PREDeFined			query only
:CATalog?			query only
:LOAD	'name'		no query
:CATalog?			no query
:LOAD	'name'		
:STORe	'name'		
:DELeTe	'name'		
:DLISt			query only
:CATalog?			
:SLOT<1 to 8>			
:TYPE	TCH SYNC VOX ADATa		
:LEVeI	OFF ATT FULL		No query
:PRESet			
:SCRamble			
:STATe	ON OFF		
:STARt	#H1 to #H1FF (9 bits)		
:SFRame			
:STATe	ON OFF		
:RCHPosition	1 to 17		
:SOURce			
:DATA	PN9 PN11 PN15 PN16 PN20 PN21 PN23 DLISt SDATa		
:DLISt	'name'		
:SACChannel	PN9 PN11 PN15 PN16 PN20 PN21 PN23 DLISt SDATa		
:DLISt	'name'		
:RCHannel	PN9 PN11 PN15 PN16 PN20 PN21 PN23 DLISt SDATa		
:DLISt	'name'		
:SI	PN9 PN11 PN15 PN16 PN20 PN21 PN23 DLISt SDATa		
:DLISt	'name'		
:PREAmble	#H0 to #HFF... (2/6/48/102 bits)		
:SYNC	#H0 to #HFF... (20/32 bits)		
:SYNC2	#H0 to #HFF... (20/32 bits)		
:CCODE	#H0 to #HFF (8 bits)		
:POSTamble	#H0 to #H3FF... (78 bits)		
:SF	0 1		

[[:SOURce]:PDC:STATe ON | OFF

The command switches the modulation on according to PDC standard. All other standards that might be switched on or digital modulation are automatically switched OFF.

Example: :SOUR:PDC:STAT ON *RST value is OFF

[[:SOURce]:PDC:STANdard

The commands sets all modulation parameters to the values of the PDC standard. I.e., all values that have been selected by the :PDC:SLOT... commands described in the following are not valid. This command triggers an event and hence has no *RST value and no query.

Example: :SOUR:PDC:STAN

[[:SOURce]:PDC:SRATe 1kHz to 200 kHz

The command sets the symbol rate.

Example: :SOUR:PDC:SRAT 21.1 kHz *RST value is 21.0 kHz

[[:SOURce]:PDC:FILTer

The commands for selecting a filter are under this node.

[[:SOURce]:PDC:FILTer:TYPE SCOSine|COSine

The command selects the type of filter.

Example: :SOUR:PDC:FILT:TYPE COS *RST value is SCOS

[[:SOURce]:PDC:FILTer:PARAmeter 0.1 to 0.7

The command sets the filter parameter entry (Roll Off factor).

Example: :SOUR:PDC:FILT:PAR 0.51 *RST value is 0.5

[[:SOURce]:PDC:FILTer:MODE LACP | LEVM

This command selects one of the "L"ow filter modes.

Example: :SOUR:PDC:FILT:MODE LEVM *RST value is LACP

[[:SOURce]:PDC:LDIStortion[:STATe] ON | OFF

The command sets the reduced level for the low-distortion mode.

Example: :SOUR:PDC:LDIS ON *RST value is OFF

[[:SOURce]:PDC:SEQuence AUTO | RETRigger | AAUTo | ARETrigger

The command selects the trigger mode for the sequence.

AAUTo is ARMED AUTO

ARETrigger is ARMED RETRIG

Example: :SOUR:PDC:SEQ AAUT *RST value is AUTO

[[:SOURce]:PDC:TRIGger:SOURce EXTernal | INTernal

The command selects the trigger source. With INT selected, triggering is via IEC/IEEE bus or the Execute command in manual control.

Example: :SOUR:PDC:TRIG:SOUR EXT *RST value is INT

[[:SOURce]:PDC:TRIGger:INHibit 0 to 67.1E6

The command sets the retrigger inhibit duration (in number of symbols).

Example: :SOUR:PDC:TRIG:INH 1000 *RST value is 0

[[:SOURce]:PDC:TRIGger:DELAy 0 to 65535

The command sets the trigger delay (in number of symbols).

Example: :SOUR:PDC:TRIG:DEL 200 *RST value is 0

[[:SOURce]:PDC:TRIGgerOUTPut[2]:DELAy 0 to 839

The command determines the delay of the signal at trigger output 2 in comparison with the start of the frames in number of symbols.

Example: :SOUR:PDC:TRIG:OUTP2:DEL 16 *RST value is 0

[[:SOURce]:PDC:TRIGger:OUTPut[2]:PERiod 1 to 67.1E6

The command sets the repeat rate (in number of frames) of the signal at trigger output 2.

Example: :SOUR:PDC:TRIG:OUTP:PER 8 *RST value is 1

[[:SOURce]:PDC:CLOCK

The commands for setting the data clock are under this node.

[[:SOURce]:PDC:CLOCK:SOURce INTernal | EXTernal

The command selects the source for the DM data clock.

INTernal The internal clock generator is used and output via the clock outputs of the serial and parallel interface.

EXTernal The clock is externally fed in via the serial interface and output via the parallel interface.

Example: :SOUR:PDC:CLOC:SOUR INT *RST value is INT

[[:SOURce]:PDC:CLOCK:MODE BIT | SYMBol

The command sets the clock mode for :PDC:CLOCK:SOURce EXTernal.

BIT The external clock has to be a bit clock.

SYMBol The external clock has to be a symbol clock.

The bit and symbol clock only differ for modulations with more than two states, ie modulations for which more than one bit is required to code each state.

Example: :SOUR:PDC:CLOC:MODE BIT *RST value is SYMB

[[:SOURCE]:PDC:CLOCK:DELay 0 to 1.0

The command sets the delay of the symbol clock (as a fraction of the length of a symbol).

Example: :SOUR:PDC:CLOC:DEL 0.75 *RST value is 0

[[:SOURCE]:PDC:PRAMP

The commands for the level control of the burst are under this node.

[[:SOURCE]:PDC:PRAMP:PRESet

This command sets the standard-stipulated values for the following commands of level control. It is an event and hence has no query and no *RST value.

Example: :SOUR:PDC:PRAM:PRES

[[:SOURCE]:PDC:PRAMP:TIME 0.25 to 16.0

The command sets the cutoff steepness (in symbol clocks).

Example: :SOUR:PDC:PRAM:TIME 2.5 *RST value is 2

[[:SOURCE]:PDC:PRAMP:DELay -1.0 to + 1.0

The command defines the shift of the envelope characteristic to the modulated signal. A positive value causes a delay of the envelope.

Example: :SOUR:PDC:PRAM:DEL 0.2 *RST value is 0

[[:SOURCE]:PDC:PRAMP:SHAPE LiNear | COSine

The command selects the linear or cosine shape of the ramp-up and ramp-down (power burst).

Example: :SOUR:PDC:PRAM:SHAP COS *RST value is COS

[[:SOURCE]:PDC:PRAMP:ROFFset -9 to +9

The command determines the timing of the ('R'ising) edge of a power burst to the beginning of the block.

Example: :SOUR:PDC:PRAM:ROFF -3 *RST value is 0

[[:SOURCE]:PDC:PRAMP:FOFFset -9 to +9

The command determines the timing of the ('F'alling) edge of a power burst to the data block

Example: :SOUR:PDC:PRAM:FOFF 4 *RST value is 0

[[:SOURCE]:PDC:SLOT:ATTenuation 0 to 70 dB

The command determines the amount by which the power of the slots marked by :PDC:SLOT:LEVEL ATT is reduced in comparison with the normal output power (Attribut to :LEVEL FULL).

Example: :SOUR:PDC:SLOT:ATT 20 dB *RST value is 0

[:SOURCE]:PDC:LINK UP | DOWN

The command determines the burst type which differs depending on the transmit direction. The structure of the frames is different and thus has an effect on the selection of possible :PDC:SLOT commands. This command is stored as a part of the :PDC:FLIST configurations described below.

UP From mobile part to fixed part

DOWN From fixed part to mobile part

Example: :SOUR:PDC:LINK DOWN

*RST value is DOWN

[:SOURCE]:PDC:RCONfiguration AHALf | FULL1 | FULL2 | FULL3 | FULL12 | FULL13 | FULL23 | AFUL

This configuration setup determines how the FULL- and HALF-rate channels (slots) are distributed among the frames. This command is stored as a part of the :PDC:FLIST configurations described below.

AHALf All Half

FULL0 FULL (0 & 3)

FULL1 FULL (1 & 4)

FULL2 FULL (2 & 5)

FULL10 FULL (1 & 4), (0 & 3)

FULL20 FULL (2 & 5), (0 & 3)

FULL21 FULL (2 & 5), (1 & 4)

AFUL All Full

Example: :SOUR:PDC:RCON FULL0

*RST value is AFUL

[:SOURCE]:PDC:FLIST

The commands for storing and reading complete frames including their bursts (slots) are under this node. Predefined and user-generated frames have to be distinguished.

[:SOURCE]:PDC:FLIST:PREDEFINED:CATalog?

The command returns a list of all predefined frames.

Example: :SOUR:PDC:FLIS:PRED:CAT?

[:SOURCE]:PDC:FLIST[:PREDEFINED]:LOAD 'name''

The command selects one of the predefined (fixed) frames (c.f. Chapter 2). This command triggers an event and hence has no *RST value.

Example: :SOUR:PDC:FLIS:PRED:LOAD 'dn_tch'

[:SOURCE]:PDC:FLIST:CATalog?

The command returns a list of all user-defined frames.

Example: :SOUR:PDC:FLIS:CAT?

[[:SOURce]:PDC:FLIS:LOAD 'name']

The command loads a user-defined frame. This command triggers an event and hence has no *RST value.

Example: :SOUR:PDC:FLIS:LOAD 'test'

[[:SOURce]:PDC:FLIS:STORe 'name']

The command stores the current frame under a name. This command triggers an event and hence has no *RST value and no query.

Example: :SOUR:PDC:FLIS:STOR 'test'

[[:SOURce]:PDC:FLIS:DELeTe 'name']

The command deletes the indicated frame. This command triggers an event and hence has no *RST value and no query.

Example: :SOUR:PDC:FLIS:DEL 'test1'

[[:SOURce]:PDC:DLIS:CATalog?]

The command returns an enumeration of all data lists.

These data lists are selected by means of :PDC:SLOT:SOUR:SACC:DLIS, ...:RCH:DLIS, ...:SI:DLIS, or ...:DATA:DLIS 'name' and used if :PDC:SLOT:SOUR:SACC, ...:RCH, SI, or ...:DATA DLIS are set.

Example: :SOUR:PDC:DLIS:CAT?

[[:SOURce]:PDC:SLOT<i>]

The commands for setting the slot characteristics are under this node. Since a frame contains 8 slots, suffix 'i' is used to select the slot to be changed. i = 0 | [1] | 2 | 3 | 3 | 5 | 6 | 7

[[:SOURce]:PDC:SLOT<i>:TYPE TCH | SYNC | VOX | ADATa]

The command selects the type of burst (slot) defined in the standard.

ADATa is All Data

Example: :SOUR:PDC:SLOT2:TYPE TCH *RST value is TCH

[[:SOURce]:PDC:SLOT<i>:LEVeL OFF | ATT | FULL]

The command determines the power stage of the slot.

OFF The slot is inactive
For UPLINK, the source is always at full power. Therefore, in the case of an DOWNLINK TCH burst, only a series of 1's is sent instead of the data.

ATT The power is reduced by the amount defined by :PDC:SLOT:ATT
For an DOWNLINK TCH burst this setting is not valid.

FULL Full power (predefined by level setting)

Example: :SOUR:PDC:SLOT2:LEV ATT *RST value is FULL

[:SOURCE]:PDC:SLOT<i>:PRESet

The command sets all the parameters of the slot to the values defined by the standard as a function of the type set above. This command triggers an event and hence has no *RST value and no query.

Example: :SOUR:PDC:SLOT2:PRES

[:SOURCE]:PDC:SLOT<i>:SCRamble

The commands for setting the scramble method are under this node.

[:SOURCE]:PDC:SLOT<i>:SCRamble:STATe ON | OFF

The command switches scrambling for data fields DATA, SI and SACCH on or off.

Example: :SOUR:PDC:SLOT2:SCR:STAT ON *RST value is OFF

[:SOURCE]:PDC:SLOT<i>:SCRamble:STARt #H1 to #H1FF (9 bits)

The command sets the start value for the scramble sequence.

Example: :SOUR:PDC:SLOT2:SCR:STAR #H12 *RST value is 1

[:SOURCE]:PDC:SLOT<i>:SFRame:STATe ON | OFF

This command switches the superframe on or off. When switched on, RCD data will be inserted instead of SACCH data in some slots and SYNC2 will be used instead of SYNC in the first slot of the superframe.

Example: :SOUR:PDC:SLOT2:SFR:STAT ON *RST value is OFF

[:SOURCE]:PDC:SLOT<i>:SFRame:RCHPosition 1 to 17

The command determines the position of the second RCH.

Example: :SOUR:PDC:SLOT2:SFR:RCHP 10 *RST value is 1

[:SOURCE]:PDC:SLOT<i>:SOURCE

The commands for determining the source for the data contents are under this node. The source is either a PRBS generator (with different sequence length), the data input SER DATA or a data list.

Selection of data source for the data fields of the burst:

PN9 to 23 PRBS generator has been selected

DLISt Data from a programmable data list

SDATa Data from data input SER DATA

[:SOURCE]:PDC:SLOT<i>:SOURCE:DATA PN9 | PN11 | PN15 | PN16 | PN20 | PN21 | PN23 | DLISt | SDATa

The command determines the data source for the data words.

Example: :SOUR:PDC:SLOT3:DATA PN15 *RST value is PN9

[:SOURce]:PDC:SLOT<i>:SOURce:DATA:DLIS 'name'

The command selects a data list. This list will not be used unless it is set as a data source by means of the `:PDC:SLOT:SOUR:DATA:DLIS` command. This command triggers an event and hence has no *RST value.

Example: `:PDC:SLOT:SOUR:DATA:DLIS 'test'`

[:SOURce]:PDC:SLOT<i>:SOURce:SACChannel PN9 | PN11 | PN15 | PN16 | PN20 | PN21 | PN23 | DLIS | SDATa

The command determines the data source for the slow associated control channel (for `:SLOT:TYPE TCH...` and `VOX`).

Example: `:SOUR:PDC:SLOT3:SOUR:SACC PN15` *RST value is PN9

[:SOURce]:PDC:SLOT<i>:SOURce:SACChannel:DLIS 'name'

The command selects a data list. This list will not be used unless it is set as a data source by means of the `:PDC:SLOT:SOUR:SACC:DLIS` command. This command triggers an event and hence has no *RST value.

Example: `:PDC:SLOT:SOUR:SACC:DLIS 'test'`

[:SOURce]:PDC:SLOT<i>:SOURce:RChannel PN9 | PN11 | PN15 | PN16 | PN20 | PN21 | PN23 | DLIS | SDATa

The command determines the data source for the housekeeping channel (for `:SLOT:FRAME:STATE ON`).

Example: `:SOUR:PDC:SLOT2:RCH:DLIS` *RST value is PN9

[:SOURce]:PDC:SLOT<i>:SOURce:RChannel:DLIS 'name'

The command selects a data list. This list will not be used unless it is set as a data source by means of the `:PDC:SLOT:SOUR:RCH:DLIS` command. This command triggers an event and hence has no *RST value.

Example: `:PDC:SLOT:SOUR:RCH:DLIS 'test'`

[:SOURce]:PDC:SLOT<i>:SOURce:SI PN9 | PN11 | PN15 | PN16 | PN20 | PN21 | PN23 | DLIS | SDATa

The command determines the data source for the sync information field (for `:SLOT:TYPE SYNC`).

Example: `:SOUR:PDC:SLOT2:SI:DLIS` *RST value is PN9

[:SOURce]:PDC:SLOT<i>:SOURce:SI:DLIS 'name'

The command selects a data list. This list will not be used unless it is set as a data source by means of the `:PDC:SLOT:SOUR:SI:DLIS` command. This command triggers an event and hence has no *RST value.

Example: `:PDC:SLOT:SOUR:SI:DLIS 'test'`

[:SOURce]:PDC:SLOT<i>:PREamble #H0 to #H... (2/6/48/102 bits)

The command sets the value of the 'P' bits. The length and the *RST value depend on the slot type and the link direction:

:SLOT:TYPE	:LINK	Length (bits)	*RST value.
TCH	UP	2	2
SYNC	UP	48	9999 9999 9999
VOX	UP	6	26
TCH	DOWN	2	2
SYNC	DOWN	102	26 6666 6666 6666 6666 6666 6666

Example: :SOUR:PDC:SLOT2:PRE #H1 For *RST value see above

[:SOURce]:PDC:SLOT<i>:SYNC #H0 to #FFFFFF/FFFFFFFF (20/32 bits)

The command sets the value of the sync word. The length 32bit is only available for SLOT:TYPE SYNC.

Example: :SOUR:PDC:SLOT2:SYNC #H1A *RST value depends on SLOT

[:SOURce]:PDC:SLOT<i>:SYNC2 #H0 to #HFF... (20/32 bits)

The command sets the value for the sync word in the superframe (only available for :PDC:SFRA:STAT ON).

Example: :SOUR:PDC:SLOT2:SYNC2 #H1AB *RST value is 0

[:SOURce]:PDC:SLOT<i>:CCODE #H0 to #HFF (8 bits)

The command sets the value for the color code.

Example: :SOUR:PDC:SLOT2:CCOD #H1F *RST value is 0

[:SOURce]:PDC:SLOT<i>:POSTamble #H0 to 3FF... (78 bits)

The command sets the value for postamble (only valid for SLOT:TYP SYNC and LINK DOWN).

Example: :SOUR:PDC:SLOT2:POST #HF2 *RST value is 2666 6666 6666 6666 6666

[:SOURce]:PDC:SLOT<i>:SF 0 | 1

The command sets the state of the steal flag.

Example: :SOUR:PDC:SLOT2:SF 1 *RST value is 0

3.5.11.14 SOURce:PHASe Subsystem

Command	Parameter	Default Unit	Remark
[:SOURce] :PHASe [:ADJust] :REFerence	-360 deg to +360 deg	rad	No query

[:SOURce]:PHASe[:ADJust] -360 deg to +360 deg

The command indicates the phase between output signal and reference oscillator signal. This setting is only accepted using `SOURce:PHASe:REFerence` (cf. below). An indication in RADian is possible.

Example: `:SOUR:PHAS:ADJ 2DEG`

`:SOUR:PHAS:ADJ 0.1RAD`

*RST value is 0.0 DEG

[:SOURce]:PHASe:REFerence

The command accepts the phase set using `SOURce:PHASe:ADJust` as a new reference phase. The command has no *RST value.

Example: `:SOUR:PHAS:REF`

3.5.11.15 SOURce:PHS Subsystem (Digital Standard)

Note #H0 to #HF are characters which are entered in alphanumeric Hex form manually. SCPI (and IEEE 488.2) also accept the entry of non-decimal characters in octal and binary such as
 #H|h <0 to 9, A|a to F|f>,
 #Q|q <0 to 7> and
 #B|b <0|1>.
 The characters are always output in Hex format after a query.

Command	Parameter	Default unit	Remark
[:SOURce]			
:PHS			
:STATe	ON OFF		
:STANdard			No query
:SRATe	1kHz to 200 kHz	Hz	
:FILTer			
:TYPE	SCOSine COSine		
:PARAmeter	0.1 to 0.7		
:MODE	LACP LEVM		
:LDISortion			
[:STATe]	ON OFF		
:SEQuence	AUTO RETRigger AAUTO ARETrigger		
:TRIGger			
:SOURce	EXTernal INTernal		
:INHibit	0 to 67.1E6		
:DELay	0 to 65535		
:OUTPut[2]			
:DELay	0 to 959		
:PERiod	1 to 67.1E6		
:CLOCK			
:SOURce	INTernal EXTernal		
:MODE	BIT SYMBol SBIT		
:DELay	0 to 1.0		
:PRAMp			No query
:PRESet			
:TIME	0.25 to 16		
:DELay	1.0 to +1.0		
:SHAPe	LINear COSine		
:ROFFset	-9 to +9		
:FOFFset	-9 to +9		

Command	Parameter	Default unit	Remark
[[:SOURce]]			
:PHS			
:FLISt			
:PREDeFined			
:CATalog?	⇒ name {,name}...		query only
:LOAD	'name'		
:CATalog?	⇒ name {,name}...		query only
:LOAD	'name'		
:STORe	'name'		no query
:DELeTe	'name'		no query
:DLISt			
:CATalog?			query only
:SLOT<1 to 8>			
:ATTenuation	0 to 70 dB	dB	
:TYPE	TCHFull TCHHalf SYNC VOX ADATa		
:LEVel	OFF ATT FULL		
:PRESet	-		No query
:SCRamble			
:STATe	ON OFF		
:CODE	#H0 to #H3FF (10 bit)		
:ENCRyption			
:STATe	ON OFF		
:KEY	#H0 to #HFFFF (16 bits)		
:UWORd	#H0 to #HFFFFFFF (16 or 32 bits)		
:CSID	#H0 to #H3FFFFFFFFF (42 bits)		
:PSID	#H0 to #HFFFFFFF (28 bits)		
:IDLe	#H0 to #H3FFFFFFFF (34 bits)		
:SOURce			
:SACChannel	PN9 PN11 PN15 PN 16 PN20 PN21 PN23 DLISt SDATa		
:DLISt	'name'		
:TCHannel	PN9 PN11 PN15 PN 16 PN20 PN21 PN23 DLISt SDATa		
:DLISt	'name'		

[[:SOURce]]:PHS:STATe ON | OFF

The command switches the modulation on according to PHS standard. All other standards that might be switched on or digital modulation are automatically switched OFF.

Example: : SOUR:PHS:STAT ON

*RST value is OFF

[[:SOURce]:PHS:STANdard

The commands sets all modulation parameters to the values of the PHS standard. I.e., all values that have been selected by the :PHS:SLOT... commands described in the following are not valid. This command triggers an event and hence has no *RST value and no query.

Example: :SOUR:PHS:STAN

[[:SOURce]:PHS:SRATe 1kHz to 200 kHz

The command sets the symbol rate.

Example: :SOUR:PHS:SRAT 192.1 kHz *RST value is 192 kHz

[[:SOURce]:PHS:FILTer

The commands for selecting a filter are under this node.

[[:SOURce]:PHS:FILTer:TYPE SCOSine|COSine

The command selects the type of filter.

Example: :SOUR:PHS:FILT:TYPE COS *RST value is SCOS

[[:SOURce]:PHS:FILTer:PARAmeter 0.1 to 0.7

The command sets the filter parameter entry (Roll Off factor).

Example: :SOUR:PHS:FILT:PAR 0.5 *RST value is 0.5

[[:SOURce]:PHS:FILTer:MODE LACP | LEVM

This command selects one of the "L"ow filter modes.

Example: :SOUR:PHS:FILT:MODE LEVM *RST value is LACP

[[:SOURce]:PHS:LDISortion[:STATe] ON | OFF

The command sets the reduced level for the low-distortion mode.

Example: :SOUR:PHS:LDIS ON *RST value is OFF

[[:SOURce]:PHS:SEQuence AUTO | RETRigger | AAUTo | ARETrigger

The command selects the trigger mode for the sequence.

AAUTo is ARMED AUTO

ARETrigger is ARMED RETRIG

Example: :SOUR:PHS:SEQ AAUT *RST value is AUTO

[[:SOURce]:PHS:TRIGger:SOURce EXTernal | INTernal

The command selects the trigger source. With INT selected, triggering is via IEC/IEEE bus or the Execute command in manual control.

Example: :SOUR:PHS:TRIG:SOUR EXT *RST value is INT

[[:SOURce]:PHS:TRIGger:INHibit 0 to 67.1E6

The command sets the retrigger inhibit duration (in number of symbols).

Example: :SOUR:PHS:TRIG:INH 1000 *RST value is 0

[[:SOURce]:PHS:TRIGger:DELay 0 to 65535

The command sets the trigger delay (in number of symbols).

Example: :SOUR:PHS:TRIG:DEL 200 *RST value is 0

[[:SOURce]:PHS:TRIGgerOUTPut[2]:DELay 0 to 959

The command determines the delay of the signal at trigger output 2 in comparison with the start of the frames in number of symbols.

Example: :SOUR:PHS:TRIG:OUTP2:DEL 16 *RST value is 0

[[:SOURce]:PHS:TRIGger:OUTPut[2]:PERiod 1 to 67.1E6

The command sets the repeat rate (in number of frames) of the signal at trigger output 2.

Example: :SOUR:PHS:TRIG:OUTP:PER 8 *RST value is 1

[[:SOURce]:PHS:CLOCK

The commands for setting the data clock are under this node.

[[:SOURce]:PHS:CLOCK:SOURce INTernal | EXTernal

The command selects the source for the DM data clock.

INTernal The internal clock generator is used and output via the clock outputs of the serial and parallel interface.

EXTernal The clock is externally fed in via the serial interface and output via the parallel interface.

Example: :SOUR:PHS:CLOC:SOUR INT *RST value is INT

[[:SOURce]:PHS:CLOCK:MODE BIT | SYMBol

The command sets the clock mode for :PHS:CLOCK:SOURce EXTernal.

BIT The external clock has to be a bit clock.

SYMBol The external clock has to be a symbol clock.

The bit and symbol clock only differ for modulations with more than two states, ie modulations for which more than one bit is required to code each state.

Example: :SOUR:PHS:CLOC:MODE BIT *RST value is SYMB

[[:SOURce]:PHS:CLOCK:DELay 0 to 1.0

The command sets the delay of the symbol clock (as a fraction of the length of a symbol).

Example: :SOUR:PHS:CLOC:DEL 0.75 *RST value is 0

[[:SOURce]:PHS:PRAMp

The commands for the level control of the burst are under this node.

[[:SOURce]:PHS:PRAMp:PRESet

This command sets the standard-stipulated values for the following commands of level control. It is an event and hence has no query and no *RST value.

Example: :SOUR:PHS:PRAM:PRES

[[:SOURce]:PHS:PRAMp:TIME 0.25 to 16.0

The command sets the cutoff steepness (in symbol clocks).

Example: :SOUR:PHS:PRAM:TIME 2.5 *RST value is 0

[[:SOURce]:PHS:PRAMp:DELay -1.0 to +1.0

The command defines the shift of the envelope characteristic to the modulated signal. A positive value causes a delay of the envelope.

Example: :SOUR:PHS:PRAM:DEL 0.2 *RST value is 0

[[:SOURce]:PHS:PRAMp:SHAPE LINear | COSine

The command selects the linear or cosine shape of the ramp-up and ramp-down (power burst).

Example: :SOUR:PHS:PRAM:SHAP COS *RST value is LIN

[[:SOURce]:PHS:PRAMp:ROFFset -9 to +9

The command determines the timing of the ('R'ising) edge of a power burst to the beginning of the slot.

Example: :SOUR:PHS:PRAM:ROFF -3 *RST value is 0

[[:SOURce]:PHS:PRAMp:FOFFset -9 to +9

The command determines the timing of the ('E'alling) edge of a power burst to the data block

Example: :SOUR:PHS:PRAM:FOFF 4 *RST value is 0

[[:SOURce]:PHS:FLISt

The commands for storing and reading complete frames including their bursts (slots) are under this node. Predefined and user-generated frames have to be distinguished.

[[:SOURce]:PHS:FLISt:PREDefined:CATalog?

The command returns a list of all predefined frames.

Example: :SOUR:PHS:FLIS:PREDEF:CAT?

[[:SOURce]:PHS:FLIS[:PREDeFined]:LOAD 'name']

The command selects one of the predefined (fixed) frames (c.f. Chapter 2). This command triggers an event and hence has no *RST value.

Example: :SOUR:PHS:FLIS:PRED:LOAD 'test' *RST value is 0

[[:SOURce]:PHS:FLIS:CATalog?]

The command returns a list of all user-defined frames.

Example: :SOUR:PHS:FLIS:CAT?

[[:SOURce]:PHS:FLIS:LOAD 'name']

The command loads a user-defined frame. This command triggers an event and hence has no *RST value.

Example: :SOUR:PHS:FLIS:LOAD 'test'

[[:SOURce]:PHS:FLIS:STORe 'name']

The command stores the current frame under a name. This command triggers an event and hence has no *RST value and no query.

Example: :SOUR:PHS:FLIS:STOR 'test'

[[:SOURce]:PHS:FLIS:DELeTe 'name']

The command deletes the indicated frame. This command triggers an event and hence has no *RST value and no query.

Example: :SOUR:PHS:FLIS:DEL 'test1'

[[:SOURce]:PHS:DLIS:CATalog?]

The command returns an enumeration of all data lists.

These data lists are selected by means of :PHS:SLOT:SOUR:SACC:DLIS 'name' and ...:TCH:DLIS 'name' and used if :PHS:SLOT:SOUR:SACC DLIS and ...:TCH DLIS are set.

Example: :SOUR:PHS:DLIS:CAT?

[[:SOURce]:PHS:SLOT<i>]

The commands for setting the slot characteristics are under this node. Since a frame contains 8 slots, suffix 'i' is used to select the slot to be changed. i = [1] | 2 | 3 | 3 | 5 | 6 | 7 | 8

[[:SOURce]:PHS:SLOT:ATTenuation 0 to 70 dB]

The command determines the amount by which the power of the slots marked by :PHS:SLOT:LEVEL ATT is reduced in comparison with the normal output power (Attribut to :LEVEL FULL).

Example: :SOUR:PHS:SLOT:ATT 20 dB *RST value is 0

[:SOURCE]:PHS:SLOT<i>:TYPE TCHFull | TCHHalf | SYNC | VOX | ADATa

The command selects the type of burst (slot) defined in the standard.

ADATa All Data

Example: :SOUR:PHS:SLOT2:TYPE TCHH

Slot1: *RST value is SYNC
Slot2 to 8: *RST value is TCHF

[:SOURCE]:PHS:SLOT<i>:LEVEL OFF | ATT | FULL

The command determines the power stage of the slot.

OFF The slot is inactive

For UPLINK, the source is always at full power. Therefore, in the case of an DOWNLINK TCH burst, only a series of 1's is sent instead of the data.

ATT The power is reduced by the amount defined by :PHS:SLOT:ATT

For an DOWNLINK TCH burst this setting is not valid.

FULL Full power (predefined by level setting)

Example: :SOUR:PHS:SLOT2:LEV ATT

slot1: *RST value is FULL
slot2 to slot8: *RST value is OFF

[:SOURCE]:PHS:SLOT<i>:PRESet

The command sets all the parameters of the slot to the values defined by the standard as a function of the type set above. This command triggers an event and hence has no *RST value and no query.

Example: :SOUR:PHS:SLOT2:PRES

[:SOURCE]:PHS:SLOT<i>:SCRamble

The commands for setting the scramble method are under this node.

[:SOURCE]:PHS:SLOT<i>:SCRamble:STATe ON | OFF

The command switches scrambling on or off.

Example: :SOUR:PHS:SLOT2:SCR:STAT ON

*RST value is OFF

[:SOURCE]:PHS:SLOT<i>:SCRamble:CODE #H0 to #H3FF

The command sets the 10-bit scramble value.

Example: :SOUR:PHS:SLOT2:SCR:CODE #H123

*RST value is 0

[:SOURCE]:PHS:SLOT<i>:ENCRyption

The commands to determine encryption are under this node.

[:SOURCE]:PHS:SLOT<i>:ENCRyption:STATe ON | OFF

This command defines whether or not the data are to be encrypted according to the predefined method.

Example: :SOUR:PHS:SLOT2:ENCR:STAT ON

*RST value is OFF

[:SOURCE]:PHS:SLOT<i>:ENCRyption:KEY #H0 to #HFFFF

The command enters the 16-bit code for encryption or decryption.

Example: :SOUR:PHS:SLOT2:KEY #H1234

*RST value is 0

[[:SOURce]:PHS:SLOT<i>:UWORD #H0 to #FFFFFFF

The command enters the 16/32-bit synchronization value (unique word). The number of bits depends on the type of slot. *RST value depends on SLOT:TYPE

Example: :SOUR:PHS:SLOT2:UWOR #HA1B2C3D4

[[:SOURce]:PHS:SLOT<i>:CSID #H0 to #H3FFFFFFF

The command enters the 42-bit cell station ID code .

Example: :SOUR:PHS:SLOT2:CSID #H12345FEDCBA

[[:SOURce]:PHS:SLOT<i>:PSID #H0 to #FFFFFFF

The command enters the 28-bit personal station ID code.

Example: :SOUR:PHS:SLOT2:PSID #H1234567

[[:SOURce]:PHS:SLOT<i>:IDLe #H0 to #FFFFFFF

The command enters the 24-bit Idle bit.

Example: :SOUR:PHS:SLOT2:PSID #H1234567

[[:SOURce]:PHS:SLOT<i>:SOURce

The commands for determining the source for the data contents are under this node. The source is either a PRBS generator (with different sequence length) or a data list.

Selection of data source for the data fields of the burst:

PN9 to 23 PRBS generator has been selected

DLIS Data of a programmable data list

SDATa Data from data input SER DATA

[[:SOURce]:PHS:SLOT<i>:SOURce:SACChannel PN9 | PN11 | PN15 | PN16 | PN20 | PN21 | PN23 | DLIS | SDATa

The command determines the data source for the slow associated control channel (for :SLOT:TYPE TCH... and VOX).

Example: :SOUR:PHS:SLOT3:SACC PN15 *RST value is PN9

[[:SOURce]:PHS:SLOT<i>:SOURce:SACChannel:DLIS 'name'

The command selects a data list. This list will not be used unless it is set as a data source by means of the :PHS:SLOT:SOUR:SACC DLIS command. This command triggers an event and hence has no *RST value.

Example: :PHS:SLOT:SOUR:SACC:DLIS 'test'

[[:SOURce]:PHS:SLOT<i>:SOURce:TChannel PN9 | PN11 | PN15 | PN16 | PN20 | PN21 | PN23 | DLIS | SDATa

The command determines the data source for the traffic channel (for :SLOT:TYPE TCH... and VOX).

Example: :SOUR:PHS:SLOT2:TCH PN9 *RST value is PN9

[[:SOURce]:PHS:SLOT<i>:SOURce:TChannel:DLIS 'name'

The command selects a data list. This list will not be used unless it is set as a data source by means of the :PHS:SLOT:SOUR:TCH DLIS command. This command triggers an event and hence has no *RST value.

Example: :PHS:SLOT:SOUR:TCH:DLIS 'test'

3.5.11.16 SOURce:PM Subsystem

This subsystem contains the commands to check the phase modulation and to set the parameters of the modulation signal. The SMIQ can be equipped with two independent phase modulators (option SM-B5). They are differentiated by a suffix after PM.

SOURce:PM1
SOURce:PM2

Command	Parameter	Default Unit	Remark
[:SOURce] :PM1 2 [:DEVIation] :EXTernal1 2 :COUPling :INTernal :FREQUency :SOURce :STATe	-360 deg to +360 deg AC DC 0.1Hz to 1 MHz INT EXT1 EXT2 ON OFF	rad Hz	Option SM-B5

[:SOURce]:PM1|2[:DEVIation] -360 to +360 deg

The command sets the modulation depth in Radian. DEGREE are accepted.

*RST value is 1 rad

Example: SOUR:PM:DEV 20DEGR

[:SOURce]:PM1|2:EXTernal1|2

The commands to check the external input of the PM modulators are under this node. The settings under EXTernal for modulations AM, FM and PM are independent of each other. The settings are always related to the socket determined by the suffix after EXTernal. The suffix after PM is ignored then. With the following commands, e.g., the settings are both related to socket EXT2:

```
:SOUR:PM1:EXT2:COUP AC
```

```
:SOUR:PM2:EXT2:COUP AC
```

A command without suffix is interpreted like a command with suffix 1.

[:SOURce]:PM1|2:EXTernal1|2:COUPling AC | DC

The command selects the type of coupling for the external PM input.

AC The d.c. voltage content is separated from the modulation signal.

DC The modulation signal is not changed.

*RST value is AC

Example: :SOUR:PM:COUP DC

[[:SOURce]:PM1|2:INTernal

The settings for the internal PM generators are effected under this node. For PM1, this is always LF generator 1, for PM2, always LF generator 2. Here the same hardware is set for FM1, PM1, AM::INT1 as well as SOURce0, for FM2, PM2 and AM:INT2 and SOURce2 as well. This means that, e.g., the following commands are coupled with each other and have the same effect:

```
SOUR:AM:INT2:FREQ
SOUR:FM2:INT:FREQ
SOUR:PM2:INT:FREQ
SOUR2:FREQ:CW
```

[[:SOURce]:PM1|2:INTernal:FREQuency 0.1 Hz to 1 MHz

The command sets the modulation frequency.

*RST value is 1 kHz

Example: :SOUR:PM:INT:FREQ 10kHz

[[:SOURce]:PM1|2:SOURce INTernal | EXTernal1 | EXTernal2

The command selects the modulation source. A command without suffix is interpreted like a command with suffix 1. For PM1 the LF generator is INTernal. For PM2, only the external sources can be used (not the internal LF generator).

The external and the internal modulation source can be indicated at the same time (see example)

*RST value for PM1: INT

Example: :SOUR:PM:SOUR INT; PM2:SOUR EXT2

for PM2:EXT2

[[:SOURce]:PM1|2:STATe ON | OFF

The command switches the phase modulation selected by the numeric suffix with PM on or off.

Example: :SOUR:PM1:STAT OFF

*RST value is OFF

3.5.11.17 SOURce:POWER Subsystem

This subsystem contains the commands to set the output level, the level control and the level correction of the RF signal. Other units can be used instead of dBm:

- by indication directly after the numeric value (Example :POW 0.5V),
- by altering the DEFault unit in the UNIT system (see Command :UNIT:POWER)

Command	Parameter	Default Unit	Remark
[:SOURce] :POWER :ALC [:STATe] :SEARch :TABLE [:MEASure]?	ON OFF AUTO ON OFF ONCE		query only
[:LEVel] [:IMMediate] [:AMPLitude]	-144 to +16 dBm	dBm	
:OFFSet	-100 to +100 dB	dB	
:RCL	INCLude EXCLude		
:LIMit [:AMPLitude]	-144 to +16 dBm	dBm	
:MANual	-144 to +16 dBm	dBm	
:MODE	FIXed SWEEp LIST		
:PEP?			
:STARt	-144 to +16 dBm	dBm	
:STOP	-144 to +16 dBm	dBm	
:STEP [:INCRement]	0.1 to 10 dB	dB	

[:SOURce]:POWER:ALC

The commands checking the automatic level control are under this node.

[:SOURce]:POWER:ALC:TABLE[:MEASure]?

The command starts a calibration measurement. It fills the level table for the POW:ALC:SEARCH OFF mode.

Example: :SOUR:POW:ALC:TABLE:MEAS?

Answer: 0

[:SOURce]:POWER:ALC[:STATe] ON | OFF | AUTO

The command switches level control on or off.

ON Level control is permanently switched on.

OFF Level control is handled depending on POW:ALC:SEAR described below.

AUTO Depending on the operating mode, level control is automatically switched on or off.

Example: :SOUR:POW:ALC:STAT ON

*RST value is ON

[[:SOURce]:POWer:ALC:SEARCh ON | OFF | ONCE

This command is only valid with level control switched off.

ON Level control is switched on briefly after a level or frequency change (SAMPLE & HOLD).

OFF Level control is never switched on (TABLE mode).

ONCE Level control is briefly switched on for calibration.

Example: :SOUR:POW :ALC:SEAR ONCE *RST value: OFF

[[:SOURce]:POWer[:LEVel][:IMMediate][:AMPLitude] -144 to +16 dBm

The command sets the RF output level in operating mode CW. UP and DOWN can be indicated in addition to numeric values. Then the level is increased or reduced by the value indicated under :SOURce:POWer:STEP.

In this command, the OFFSet value is considered as with input value AMPLITUDE in the LEVEL-LEVEL menu. Thus the specified range indicated is only valid for :POWer:OFFSet = 0. The specified range with other OFFSet values can be calculated according to the following formula (cf. Chapter 2, Section "Level Offset" as well):

$$-144\text{dBm} + \text{OFFSet} \text{ to } +16\text{dBm} + \text{OFFSet}$$

The keywords of this command are optional to a large extent, thus the long as well as the short form of the command is shown in the example. *RST value is -30 dBm

Example: :SOUR:POW:LEV:IMM:AMPL 15 or
:POW 15

[[:SOURce]:POWer[:LEVel][:IMMediate][:AMPLitude]:OFFSet -100 to +100 dB

The command enters the constant level offset of a series-connected attenuator/ amplifier (cf. Chapter 2, Section "Level Offset"). If a level offset is entered, the level entered using :POWer:AMPLitude does no longer conform to the RF output level. The following connection is true:

$$\text{:POWer} = \text{RF output level} + \text{POWer:OFFSet.}$$

Entering a level offset does not change the RF output level but only the query value of :POWer:AMPLitude.

Only dB is permissible as a unit here, linear units (V, W etc.) are not permitted.

Caution: The level offset is also valid in the case of level sweeps!

Example: :SOUR:POW:LEV:IMM:AMPL:OFFS 0 oder *RST value is 0
:POW:OFFS 0

[[:SOURce]:POWer[:LEVel][:IMMediate][:AMPLitude]:RCL INCLude | EXCLude

The command determines the effect of the recall function on the RF level.*RST value has no effect to this setting.

INCLude The saved RF level is loaded when instrument settings are loaded with the [RECALL] key or with a memory sequence.

EXCLude The RF level is not loaded when instrument settings are loaded, the current settings are maintained.

Example: :SOUR:POW:RCL INCL

[[:SOURce]:POWer:LIMit[:AMPLitude]] -144 to + 16 dBm

The command limits the maximum Rf output level in operating mode CW and SWEEP. It does not influence the display LEVEL and the answer to query POW?.

Example: :SOUR:POW:LIM:AMPL 15 *RST value is +16 dBm

[[:SOURce]:POWer:MANual] -144 to +16 dBm

The command sets the level if SOURce:POWer:MODE is set to SWEep and SOURce:SWEep:MODE to MANual. Only level values between START and STOP are permissible. (As to specified range, cf. :POWer).

Example: :SOUR:POW:MAN 1dBm

*RST value is -30 dBm

[[:SOURce]:POWer:MODE] FIXed | SWEep | LIST

The command specifies the operating mode and thus also by means of which commands the level setting is checked.

FIXed The output level is specified by means of commands under :SOURce:POWer:LEVel.

SWEep The instrument operates in the SWEep mode. The level is specified by means of :SOURce:POWer;STARt; STOP; CENTer; SPAN and MANual.

LIST The instrument processes a list of frequency and level settings. The settings are effected in the SOURce:LIST subsystem.

Setting :SOURce:POWer:MODE LIST automatically sets command :SOURce:FREQuency :MODE to LIST as well.

Example: :SOUR:POW:MODE FIX

*RST value is FIXed

[[:SOURce]:POWer:PEP?]

This command returns the peak envelope power in dBm (Digital Modulation and Digital Standards)

Example: :POW:PEP?

[[:SOURce]:POWer:STARt] -144 to +16 dBm

The command sets the starting value for a level sweep. STARt may be larger than STOP, then the sweep runs from the high to the low level (As to specified range, cf. :POWer:AMPLitude).

Example: :SOUR:POW:STAR -20

*RST value is -30dBm

[[:SOURce]:POWer:STOP] -144 to +16 dBm

The command sets the final value for a level sweep. STOP may be smaller than STARt. (As to specified range, cf. :POWer:AMPLitude).

Example: :SOUR:POW:STOP 3

*RST value is -10dBm

[[:SOURce]:POWer:STEP[:INCRement]] 0.1 to 10 dB

The command sets the step width with the level setting if UP and DOWN are used as level values. The command is coupled with KNOB STEP in the manual control, i.e., it also specifies the step width of the shaft encoder.

Only dB is permissible as a unit here, the linear units (V, W etc.) are not permitted.

Example: :SOUR:POW:STEP:INCR 2

*RST value is 1dB

3.5.11.18 SOURce:PULM Subsystem

This subsystem contains the commands to check the external pulse modulation

Command	Parameter	Default Unit	Remark
[:SOURce] :PULM :POLarity :STATE	NORMal INVerted ON OFF		

[:SOURce]:PULM:POLarity NORMal | INVerted

The command specifies the polarity between modulating and modulated signal.

NORMal The RF signal is suppressed during the interpulse period.

INVerted The RF signal is suppressed during the pulse.

Example: :SOUR:PULM:POL INV

*RST value is NORMal

[:SOURce]:PULM:STATE ON | OFF

The command switches on or off the pulse modulation.

Example: :SOUR:PULM:STAT ON

*RST value is OFF

3.5.11.19 SOURce:ROSCillator Subsystem

This subsystem contains the commands to set the external and internal reference oscillator.

Command	Parameter	Default Unit	Remark
[:SOURce] :ROSCillator :EXTernal :FREQuency [:INTernal] :ADJust [:STATe] :VALue :SOURce	1 to 16 MHz ON OFF 0 to 4095 INTernal EXTernal	Hz	

[:SOURce]:ROSCillator:EXTernal

The commands to set the external reference oscillator are under this node.

[:SOURce]:ROSCillator:EXTernal:FREQuency 1 to 16 MHz

The command informs the instrument about at which frequency the external reference oscillator oscillates.

Example: :SOUR:ROSC:FREQ 5MHz *RST value is 10 MHz

[:SOURce]:ROSCillator[:INTernal]:ADJust

The commands for frequency correction (fine adjustment of the frequency) are under this node.

[:SOURce]:ROSCillator[:INTernal]:ADJust[:STATe] ON | OFF

The command switches the fine adjustment of the frequency on or off.

Example: :SOUR:ROSC:INT:ADJ:STAT ON *RST value is OFF

[:SOURce]:ROSCillator[:INTernal]:ADJust:VALue 0 to 4095

The command indicates the frequency correction value (tuning value). For a detailed definition, cf. Chapter 2, Section "Reference Frequency Internal/External".

Example: :SOUR:ROSC:INT:ADJ:VAL 2048 *RST value is 2048

[:SOURce]:ROSCillator:SOURce INTernal | EXTernal

The command selects the reference source.

INTernal The internal oscillator is used.

EXTernal The reference signal is fed externally.

*RST value is INTernal

Example: :SOUR:ROSC:SOUR EXT

3.5.11.20 SOURce:SWEEP Subsystem

This subsystem contains the commands to check the RF sweep, i.e., sweeps of the RF generators. Sweeps are triggered on principle. The frequency sweep is activated by command SOURce:FREQUENCY:MODE SWEEP, the level sweep by command SOURce:POWER:MODE SWEEP.

Command	Parameter	Default Unit	Remark
[:SOURce] :SWEEP :BTIME [:FREQUENCY] :DWELL :MODE :POINTS :SPACING :STEP [:LINEAR] :LOGARITHMIC :POWER :DWELL :MODE :POINTS :STEP [:LOGARITHMIC]	NORMAL LONG 10 ms to 5 s AUTO MANUAL STEP Number LINEAR LOGARITHMIC 0 to 1 GHz 0.01 to 50 PCT 10 ms to 5 s AUTO MANUAL STEP Number 0 to 10 dB	 s Hz PCT s dB	

[:SOURce]:SWEEP:BTIME NORMAL | LONG
The command sets the blank time (Blank TIME) of the sweep. The setting is valid for all sweeps, i.e., also for LF sweeps.
NORMAL Blank time as short as possible.
LONG Blank time long enough to permit an XY recorder to return to 0.
Example: :SOUR:SWEEP:BTIME LONG *RST value is NORM

[:SOURce]:SWEEP[:FREQUENCY]
The commands to set the frequency sweeps are under this node. Keyword [:FREQUENCY] can be omitted (cf. examples). The commands are SCPI compatible then unless stated otherwise.

[:SOURce]:SWEEP[:FREQUENCY]:DWELL 10 ms to 5 s
The command sets the dwell time per frequency step.
Example: :SOUR:SWEEP:DWELL 12ms *RST value is 15 ms

[[:SOURce]:SWEep[:FREQUENCY]:MODE AUTO | MANual | STEP

The command specifies the run of the sweep.

AUTO Each trigger triggers exactly one entire sweep cycle.

MANual Each frequency step of the sweep is triggered by means of manual control or a `SOURce:FREQUENCY:MANual` command, the trigger system is not active. The frequency increases or decreases (depending on the direction of the shaft encoder) by the value indicated under `[[:SOURce]:FREQUENCY:STEP:INCREMENT]`.

STEP Each trigger triggers only one sweep step (single-step mode). The frequency increases by the value indicated under `[[:SOURce]:SWEep:STEP:LOGarithmic]`.

Example: `:SOUR:SWE:MODE AUTO` *RST value is AUTO

[[:SOURce]:SWEep[:FREQUENCY]:POINTS Number

The command determines the number of steps in a sweep.

Instead of this command, commands `SOURce:SWEep:FREQUENCY:STEP:LINear` and `SOURce:SWEep:FREQUENCY:STEP:LOGarithmic` should be used, as `SOURce:SWEep:FREQUENCY:POINTS` has been adapted to the instrument characteristics in comparison to the SCPI command.

The value of `POINTS` depends on `SPAN` and `STEP` according to the following formulas..

The following is true for linear sweeps : $POINTS = SPAN / STEP:LIN + 1$

The following is true for logarithmic sweeps and `START < STOP`:

$$POINTS = ((\log STOP - \log START) / \log (1 + STEP:LOG))$$

Two independent `POINTS` values are used for `SPACING LOG` and `SPACING LIN`. I.e., before `POINTS` is changed, `SPACING` must be set correctly. A change of `POINTS` results in an adaptation of `STEP`, but not of `START`, `STOP` and `SPAN`.

Example: `:SOUR:SWE:POIN 100`

[[:SOURce]:SWEep[:FREQUENCY]:SPACING LINear | LOGarithmic

The command selects whether the steps have linear or logarithmic spacings.

Example: `:SOUR:SWE:SPAC LIN` *RST value is LINear

[[:SOURce]:SWEep[:FREQUENCY]:STEP[:LINear] 0 to 1 GHz

The command sets the step width with the linear sweep. If `STEP[:LINear]` is changed, the value of `POINTS` valid for `SPACING:LINear` also changes according to the formula stated under `POINTS`. A change of `SPAN` does not result in a change of `STEP[:LINear]`. Keyword `[:LINear]` can be omitted, then the command conforms to SCPI regulations (see example).

Example: `:SOUR:SWE:STEP 1MHz` *RST value is 1 MHz

[[:SOURce]:SWEep[:FREQUENCY]:STEP:LOGarithmic 0.01 to 50 PCT

The command indicates the step width factor for logarithmic sweeps. The next frequency value of a sweep is calculated according to

new frequency = prior frequency + `STEP:LOG` x prior frequency (if `START < STOP`)

`STEP:LOG` indicates the fraction of the prior frequency by which this is increased for the next sweep step. Usually `STEP:LOG` is indicated in percent, with the suffix `PCT` having to be used explicitly. If `STEP:LOG` is changed, the value of `POINTS` valid for `SPAC:LOG` also changes according to the formula stated under `POINTS`. A change of `START` or `STOP` does not result in a change of `STEP:LOG`.

Example: `:SOUR:SWE:STEP:LOG 10PCT` *RST value is 1 PCT

[:SOURce]:SWEep:POWer:DWELI 10 ms to 5 s

The command sets the dwell time per level step.

Example: `:SOUR:SWE:POW:DWEL 12ms`

*RST value is 15 ms

[:SOURce]:SWEep:POWer:MODE AUTO | MANual | STEP

The command specifies the run of the sweep.

AUTO Each trigger triggers exactly one entire sweep cycle.

MANual Each level step of the sweep is triggered by means of manual control or a `SOURce:POWer:MANual` command, the trigger system is not active. The level increases or decreases (depending on the direction of the shaft encoder) by the value stated under `:SOURce:POWer:STEP:INCRement`.

STEP Each trigger triggers only one sweep step (single-step mode). The level increases by the value indicated under `:SOURce:POWer:STEP:INCRement`.

Example: `:SOUR:SWE:POW:MODE AUTO`

*RST value is AUTO

[:SOURce]:SWEep:POWer:POINts Number

The command determines the number of steps in a sweep. Instead of this command, command `SOURce:SWEep:POWer:STEP:LOGarithmic` should be used, as **POINts** has been adapted to the instrument characteristics in comparison to the SCPI command.

The value of `:POINts` depends on `.SPAN` and `:STEP` according to the following formulas:

$$\text{POINts} = ((\log \text{STOP} - \log \text{START}) / \log \text{STEP:LOG}) + 1$$

A change of **POINts** results in an adaptation of `STEP` but not of `START` and `STOP`.

Example: `:SOUR:SWE:POW:POIN 100`

[:SOURce]:SWEep:POWer:STEP[:LOGarithmic] 0 to 10 dB

The command indicates the step width factor for logarithmic sweeps. The next level value of a sweep is calculated according to

$$\text{new level} = \text{prior level} + \text{STEP:LOG} \times \text{prior level}$$

`STEP:LOG` indicates the fraction of the prior level by which this is increased for the next sweep step. Usually `STEP:LOG` is indicated in dB, with suffix dB having to be used explicitly. If `STEP:LOG` is changed, the value of **POINts** also changes according to the formula indicated under **POINts**. A change of `START` or `STOP` does not result in a change of `STEP:LOG`. Keyword `:LOG` can be omitted, then the command conforms to SCPI regulation (see example).

Example: `:SOUR:SWE:STEP:LOG 10dB`

*RST value is 1dB

3.5.12 SOURce2 System

The SOURce2 system contains the commands to configure the LF signal source. It is designated as INT if used as a modulation source (cf. command SOURce:AM:SOURce INT, e.g.).

The commands to set the output voltage of the LF generators are in the OUTPut2 system.

Subsystems	Settings
:SOURce2 :FREQuency :MARKer :SWEep	Frequency with CW and sweep operation. Marker for LF sweeps (only possible using SOURce2) LF sweep (only possible using SOURce2)

3.5.12.1 SOURce2:FREQuency Subsystem

This subsystem contains the commands for the frequency settings in operating modes CW and SWEep for the LF generator.

Command	Parameter	Default Unit	Remark
:SOURce2 :FREQuency [:CW :FIXed] :MANual :MODE :START :STOP	0.1 Hz to 1 MHz 0.1 Hz to 1 MHz CW FIXed SWEep 0.1 Hz to 1 MHz 0.1 Hz to 1 MHz	Hz Hz Hz Hz	

:SOURce2:FREQuency[:CW | :FIXed] 0.1 Hz to 1 MHz

The command sets the frequency for the CW mode.

RST value is 1 kHz

Example: :SOUR2:FREQ: CW 1kHz

:SOURce2:FREQuency:MANual 0.1 Hz to 1 MHz

The command sets the frequency if SOURce2:SWEep:MODE MANual and SOURce2:FREQuency: MODE SWEep are set. In this case, only frequency values between the settings SOURce2: FREQuency: START and to :STOP are allowed.

Example: :SOUR2:FREQ:MAN 1kHz

*RST value is 1kHz

:SOURce2:FREQuency:MODE CW|FIXed|SWEep

The command specifies the operating mode and hence by means of which commands the FREQuency subsystem is checked. The following allocations are valid:

CW|FIXed CW and FIXed are synonyms. The output frequency is specified by means of `SOURce2:FREQuency:CW|FIXed`.

SWEep The generator operates in the SWEep mode. The frequency is specified by means of commands `SOURce2:FREQuency:START; STOP; MANual`.

Example: `:SOUR2:FREQ:MODE CW` *RST value is CW

:SOURce2:FREQuency:START 0.1 Hz to 1 MHz

This command indicates the starting value of the frequency for the sweep.

Example: `:SOUR2:FREQ:STAR 100kHz` *RST value is 1kHz

:SOURce2:FREQuency:STOP 0.1 Hz to 1 MHz

This command indicates the end value of the frequency for the sweep.

Example: `:SOUR2:FREQ:STOP 200kHz` *RST value is 100 kHz

3.5.12.2 SOURce2:MARKer-Subsystem

This subsystem contains the commands to check the marker generation in the case of LF sweeps. The three markers existing are differentiated by a numeric suffix after marker.

Command	Parameter	Default Unit	Remark
:SOURce2 :MARKer1 2 3 [:FSweep] :AOFF :FREQuency [:STATe] :POLarity	0.1 Hz to 1 MHz ON OFF NORMal INVerted	Hz	Option SM-B2/B6 No query

:SOURce2:MARKer1|2|3[:FSweep]

The commands for the markers with the LF frequency sweep (Frequency Sweep) are under this node. Keyword [:FSweep] can also be omitted, then the command conforms to SCPI regulation (see examples).

:SOURce2:MARKer1|2|3[:FSweep]:AOFF

The command switches off all LF frequency markers. This command triggers an event, thus it has no *RST value and no query form.

Example: :SOUR2:MARK:AOFF

:SOURce2:MARKer1|2|3[:FSweep]:FREQuency 0.1 Hz to 1 MHz

The command sets the marker selected by the numeric suffix at MARKer to the frequency indicated.

*RST value for MARK1: 100kHz

MARK2: 10kHz

MARK3: 1kHz

Example: :SOUR2:MARK1:FREQ 9000

:SOURce2:MARKer1|2|3[:FSweep][:STATe] ON | OFF

The command switches on or off the marker selected by the numeric suffix at MARKer.

Example: :SOUR2:MARK1:STAT ON

*RST value is OFF

:SOURce2:MARKer1|2|3:POLarity NORMal | INVerted

The command specifies the polarity of the marker signal as follows:

NORMal When running through the marker condition, TTL level is applied at the marker output, otherwise 0 V.

INVers When running through the marker condition, 0 V is applied at the marker output, otherwise TTL level.

*RST value is NORM

Example: :SOUR2:MARK1:POL INV

3.5.12.3 SOURce2:SWEep-Subsystem

This subsystem contains the commands to check the LF sweep of SOURce2. Sweeps are triggered on principle.

Command	Parameter	Default Unit	Remark
:SOURce2 :SWEep :BTIMe [:FREQuency] :DWELI :MODE :POINts :SPACing :STEP [:LINear] :LOGarithmic	NORMal LONG 1 ms to 1 s AUTO MANual STEP Number LINear LOGarithmic 0 to 500 kHz 0.01 PCT to 50 PCT	 s Hz PCT	Option SM-B2

:SOURce2:SWEep:BTIMe NORMal | LONG

The command sets the blank time (Blank TIME) of the sweep. The setting is valid for all sweeps, i.e., also for RF sweeps

NORMal Blank time as short as possible.

LONG Blank time long enough to permit an X/Y recorder to return to 0.

Example: :SOUR2:SWE:BTIM LONG *RST value is NORM

:SOURce2:SWEep

The commands to set the frequency sweeps are under this node. Keyword [:FREQuency] can be omitted. Then the commands are SCPI-compatible unless stated otherwise (see examples).

:SOURce2:SWEep[:FREQuency]:DWELI 1 ms to 1 s

The command sets the time per frequency step (dwell).

Example: :SOUR2:SWE:DWEL 20ms *RST value is 15 ms

:SOURce2:SWEep[:FREQuency]:MODE AUTO | MANual | STEP

The command specifies the run of the sweep.

AUTO Each trigger triggers exactly one entire sweep cycle.

STEP Each trigger triggers only one sweep step (single-step mode). The frequency increases by the value indicated under :SOURce2:SWEep

Example: :SOUR2:SWE:MODE AUTO *RST value is AUTO

:SOURce2:SWEep[:FREQUENCY]:POINTS Number

The command determines the number of steps in a sweep. Instead of this command, commands `:SOURce2:FREQUENCY:STEP:LINEar` and `:SOURce2:FREQUENCY:STEP:LOGarithmic` should be used, as `:SOURce2:SWEep:FREQUENCY:POINTS` has been adapted to the instrument characteristics in comparison to the SCPI command. The value of POINTs depends on SPAN and STEP according to the following formulas.

The following is true of linear sweeps : $POINTS = SPAN / STEP:LIN + 1$

The following is true of logarithmic sweeps and START < STOP:

$$POINTS = ((\log STOP \log START) / \log STEP:LOG) + 1$$

Two independent POINTs values are used for SPACING LOG and SPACING LIN. That is to say, before POINTs is changed, SPACING must be set correctly. A change of POINTs causes an adaption of STEP, but not of START, STOP and SPAN.

Example: `:SOUR2:SWE:POIN 50`

:SOURce2:SWEep[:FREQUENCY]:SPACING LINEar | LOGarithmic

The command selects whether the steps have linear or logarithmic spacings.

Example: `:SOUR2:SWE:SPAC LOG` *RST value is LINEar

:SOURce2:SWEep[:FREQUENCY]:STEP

The commands to set the step width with linear and logarithmic sweeps are under this node. The settings of STEP:LIN and STEP:LOG are independent of each other.

:SOURce2:SWEep[:FREQUENCY]:STEP[:LINEar] 0 to 500 kHz

The command sets the step width with the linear sweep. If STEP:LINEar is changed, the value of POINTs valid for SPACING:LINEar also changes according to the formula indicated under POINTs. A change of SPAN does not cause a change of STEP:LINEar. Keyword [:LINEar] can be omitted, then the command conforms to SCPI regulation (see example)

Example: `:SOUR2:SWE:STEP 10kHz` *RST value is 1 kHz

:SOURce2:SWEep[:FREQUENCY]:STEP:LOGarithmic 0.01 to 50PCT

The command indicates the step width factor for logarithmic sweeps. The next frequency value of a sweep is calculated according to (if START < STOP) :

new frequency = prior frequency + STEP:LOG x prior frequency

Thus STEP:LOG indicates the fraction of the prior frequency by which this is increased for the next sweep step. Usually STEP:LOG is indicated in percent, with the suffix PCT having to be used explicitly. If STEP:LOG is changed, the value of POINTs valid for SPACING:LOGarithmic also changes according to the formula stated unde

Example: `:SOUR2:SWE:STEP:LOG 5PCT` *RST value is 1 PCT

3.5.13 STATUS-System

This system contains the commands for the status reporting system (c.f. Section "Status Reporting System"). *RST has no influence on the status registers.

Command	Parameter	Default Unit	Remark
:STATUS			
:OPERation			
[:EVENT]?			Query only
:CONDition?			Query only
:PTRansition	0 to 32767		
:NTRansition	0 to 32767		
:ENABle	0 to 32767		
:PRESet			No query
:QUEStionable			
[:EVENT]?			Query only
:CONDition?			Query only
:PTRansition	0 to 32767		
:NTRansition	0 to 32767		
:ENABle	0 to 32767		
:QUEue			
[:NEXT]?			Query only

:STATUS:OPERation

The commands for the STATUS:OPERation register are under this node.

:STATUS:OPERation[:EVENT]?

The command queries the content of the EVENT part of the STATUS:OPERation register. In reading out, the content of the EVENT part is deleted.

Example: :STAT:OPER:EVEN?

Response: 17

:STATUS:OPERation:CONDition?

The command queries the content of the CONDition part of the STATUS:OPERation register. In reading out, the content of the CONDition part is not deleted. The value returned directly reflects the current hardware state.

Example: :STAT:OPER:COND?

Response: 1

:STATUS:OPERation:PTRansition 0 to 32767

The command (Positive TRansition) sets the edge detectors of all bits of the STATUS:OPERation register from 0 to 1 for the transitions of the CONDition bits.

Example: :STAT:OPER:PTR 32767

:STATUS:OPERation:NTRansition 0 to 32767

The command (Negative TRansition) sets the edge detectors of all bits of the STATUS:OPERation register from 1 to 0 for the transitions of the CONDition bit.

Example: :STAT:OPER:NTR 0

:STATUS:OPERation:ENABLE 0 to 32767

The command sets the bits of the ENABLE register. This register selectively enables the individual events of the appropriate status event register for the sum bit in the status byte.

Example: :STAT:OPER:ENAB 1

:STATUS:PRESet

The command resets the edge detectors and ENABLE parts of all registers to a defined value. All PTRansition parts are set to FFFFh, i.e., all transitions from 0 to 1 are detected. All NTRansition parts are set to 0, i.e., a transition from 1 to 0 in a CONDition bit is not detected. The ENABLE parts of STATUS:OPERation and STATUS:QUESTionable are set to 0, i.e., all events in these registers are not passed on.

Example: :STAT:PRES

:STATUS:QUESTionable

The commands for the STATUS:QUESTionable register are under this node.

:STATUS:QUESTionable[:EVENT]?

The command queries the content of the EVENT part of the STATUS:QUESTionable register. In reading out, the content of the EVENT part is deleted.

Example: :STAT:QUES:EVEN? Response: 1

:STATUS:QUESTionable:CONDition?

The command queries the content of the CONDition part of the STATUS:QUESTionable register. In reading out, the content of the CONDition part is not deleted.

Example: :STAT:QUES:COND? Response: 2

:STATUS:QUESTionable:PTRansition 0 to 32767STATUS:QUESTionable:PTRansitionβ to

The command (Positive Transition) sets the edge detectors of all bits of the STATUS:QUESTionable register from 0 to 1 for transitions of the CONDition bit.

Example: :STAT:QUES:PTR 32767

:STATUS:QUESTionable:NTRansition 0 to 32767

The command (Negative Transition) sets the edge detectors of all bits of the STATUS:QUESTionable register from 1 to 0 for transitions of the CONDition bit.

Example: :STAT:QUES:NTR 0

:STATUS:QUESTionable:ENABLE 0 to 32767

The command sets the bits of the ENABLE part of the STATUS:QUESTionable register. This part selectively enables the individual events of the appropriate EVENT part for the sum bit in the status byte

Example: :STAT:QUES:ENAB 1

:STATUS:QUEue [:NEXT]?

The command queries the entry that has been in the error queue for the longest time and thus deletes it. Positive error numbers denote errors specific of the instrument, negative error numbers error messages specified by SCPI (see annex B). If the error queue is empty, 0, "No error", is returned. The command is identical to SYSTem :ERRor?

Example: STATUS:QUEue:NEXT? Response: -221, "Settings conflict"

3.5.14 SYSTem-System

In this system, a number of commands for general functions which are not immediately related to signal generation, are combined.

Command	Parameter	Default Unit	Remark
:SYSTem			
:BEEPer			
:STATe	ON OFF		
:COMMunicate			
:GPIB			
:LTERminator	EOI STANdard		
[[:SELF]]			
:ADDRess	0 to 30		
:SDATa			
:BAUD	1200 2400 4800 9600 19200 38400 57600 115200		
:SERial			
:CONTRol			
:RTS	ON IBFull RFR		
:BAUD	1200 2400 4800 9600 19200 38400 57600 115200		
:PACE	XON NONE		
:ERRor?			Query only
:KLOCK	ON OFF		
:MODE	FIXed MSEQUence		
:MSEQUence			
:CATalog?			Query only
:DELete	"Name of sequence"		
:ALL			
:DWELI	50 ms to 60 s {,50 ms to 60 s}	s	
:FREE?			
:MODE	AUTO STEP		
[[:RCL]]	1 to 50 {,1 to 50}		
:POINts?			Query only
:SELect	"Name of sequence"		
:PRESet			No query
:PROTect			
[[:STATe]]	ON OFF , password		
:SECurity			
[[:STATe]]	ON OFF		
:SERRor?			Query only
:VERSion?			Query only
:SSAVe	1 to 1000		SMIQ03A / SM-B50
:SREStore	1 to 1000		SMIQ03A / SM-B50
!	<least significant byte> <most significant byte>		SMIQ03A / SM-B50

:SYSTem:BEEPer:STATE ON | OFF

This node contains the commands to set the beeper fitted.

*RST value is OFF

Example: :SYST:BEEP:STAT OFF

:SYSTem:COMMunicate:GPIB

The commands to check the IEC bus are under this node (GPIB = General Purpose Interface Bus)

:SYSTem:COMMunicate:GPIB:LTERminator EOI | STANdard

The command activates the delimiter identification mode.

EOI only signs transmitted with the circuit message EOI are identified. The EOI mode is particularly suitable for binary block transmission where an arbitrary sign not representing a delimiter could accidentally have the value LF

STANdard LF (with or without EOI) is identified as a delimiter as well.

Example: :SYST:COMM:GPIB:LTER EOI

*RST value is STAN

:SYSTem:COMMunicate:GPIB[:SELf]:ADDRess 1 to 30

The command sets the IEC bus instrument address.

*RST value is 28

Example: :SYST:COMM:GPIB:ADDR 1

:SYSTem:COMMunicate:SDATa:BAUD 1200| 2400| 4800| 9600| 19200| 38400| 57600| 115200

The commands sets the baud rate for the asynchronous data (connector SERDATA) for digital modulation and digital standards.. *RST has no influence on this parameter.

Example: :SYST:COMM:SDAR:BAUD 1200

*RST value is 9600

:SYSTem:COMMunicate:SERial

The command to set the serial interface are under this node. The data format is fixedly set to 8 data bits, no parity and 1 stop bit. These values cannot be changed. The device represents a DTE (Data Terminal Equipment) in relation to the serial interface. Therefore the the controller must be connected via a 0-modem.

:SYSTem:COMMunicate:SERial:BAUD 1200| 2400| 4800| 9600| 19200| 38400| 57600| 115200

The commands sets the baud rate for both the transmit and the receive direction. *RST has no influence on this parameter.

Example: :SYST:COMM:SER:BAUD 1200

*RST value is 9600

:SYSTem:COMMunicate:SERial:CONTRol:RTS ON | IBFull | RFR

he commands sets the hardware handshake. *RST has no influence on this parameter.

ON Interface line RTS is always active.

IBFull | RFR Input Buffer Full | Ready For Receiving. Interface line RTS remains active as long as the instrument is ready to receive data

Example: :SYST:COMM:SER:CONT:RTS ON

*RST value is RFR

:SYSTem:COMMunicate:SERial:PACE XON | NONE

The command sets the software handshake. *RST has no influence on this parameter.

XON Software handshake using the ASCII codes 11h (XON) and 13h (XOFF).

Note: *This mode is not recommended for binary data and for baud rates above 9600 bauds.*

NONE No software handshake.

Example: :SYST:COMM:SER:PACE NONE *RST value is NONE

:SYSTem:ERRor?

The command queries the entry that has been in the error queue for the longest time. Positive error numbers denote errors specific of the instrument, negative error numbers denote error messages specified by SCPI (see annex B). If the error queue is empty, 0, "No error", is returned. The command is identical to STATus:QUEue:NEXT?

Example: :SYST:ERR? Response: -221, "Settings conflict"

:SYSTem:KLOCK ON | OFF

The command (Keyboard LOCK) disables the keyboard of the SMIQ including the [LOCAL] key or enables it again (OFF).

Caution: *If :SYSTem:SECurity is ON, the keyboard cannot be enabled, i.e., :SYSTem:KLOCK OFF is not accepted. If the disabling of the command is released by switching over to :SYSTem:SECurity OFF, data will be lost.*

Example: :SYST:KLOC ON *RST value is OFF

:SYSTem:MODE FIXed | MSEQence

The command sets the operating mode of the instrument.

FIXed The overall instrument state can only be switched over using *RCL.

MSEQence The instrument successively sets the instrument states indicated under :SYSTem:MSEQence:RCL. *RST value is FIXed

Example: :SYST:MODE FIX

:SYSTem:MSEQence

This node follows the SOURce:LIST system. It can manage several memory sequences which each consist of a list of instrument state numbers and a time list. If :SYSTem:MODE is switched to MSEQence, the instrument states stated in the list selected are set successively for the time stated in the time list in each case.

:SYSTem:MSEQence:CATalog?

The command queries the memory sequences available. It returns a list, the entries are separated by means of commas.

Example: :SYST:MSEQ:CAT? Response: "SEQ1", "DEMO", "SEQA"

:SYSTem:MSEquence:SElect "Name of sequence"

The command selects a memory sequence. The name of the sequence may be an arbitrary character string of up to 7 letters. If there is no memory sequence of the name indicated, the command creates it, i.e., this command can be used to generate new lists.

Example: :SYST:MSEQ:SEL "SEQA"

:SYSTem:PRESet

The command triggers an instrument reset. It has the same effect as the RESET key of the manual control or as command *RST. This command triggers an event and hence has no *RST value.

Example: :SYST:PRES

:SYSTem:PROTect1|2|3

The commands to disable certain instrument functions are under this node. A list of the functions concerned can be found in the manual control (Section Password Input With Protected Functions). There are three protection levels which are differentiated by means of a suffix after PROTect. *RST has no effects on the disabling/enabling of the instrument functions.

:SYSTem:PROTect1|2|3 [:STATe] ON | OFF, password

The command switches a protection level on or off. The passwords are 6-digit numbers. They are fixedly stored in the firmware. The password for the first level is 123456.

ON disables the functions belonging to this protection level. A password need not be indicated.

OFF deactivates the disabling again if the correct password is indicated. Otherwise an error -224, "Illegal parameter value" is generated and STATe remains ON.

Example: :SYST:PROT1:STAT OFF, 123456

:SYSTem:SECurity

The commands setting the security characteristics of the instrument are under this node.

:SYSTem:SECurity[:STATe] ON | OFF

The command switches the security state on or off. The command is not influenced by *RST and *RCL.

ON The following commands cannot be executed:
 :DISPlay:ANNotation:ALL ON
 :DISPlay:ANNotation:FREQ ON
 :DISPlay:ANNotation:AMPLitude ON
 :SYSTem:KLOCK OFF

OFF In the transition from ON to OFF all data existing in the instrument except for the calibrating data are deleted, especially all status registers, all instrument states and all lists.

Example: :SYST:SEC:STAT ON

:SYSTem:SERRor?

This command returns a list of all errors existing at the point of time of the query. This list corresponds to the indication on the ERROR page with manual control (cf. Section Error Messages).

Example: :SYST:SERR?

Response: -221, "Settings conflict", 153, "Input voltage out of range"

:SYSTem:VERSion?

The command returns the SCPI version number the instrument acts in accordance with. This command is a query and thus has no *RST value.

Example: :SYST:VERS?

Response: 1994.0

The following commands are only valid in conjunction with model SMIQ03A or option SMIQB50 (see also Section 'Fast Restore Mode').

:SYSTem:SSAVe 1...1000

This command saves the current device setting at the memory location indicated.

:SYSTem:SREStore 1...1000

This command loads a device status that was stored using the :SYSTem:SSAVe command (RESTORE). One of 1000 available memory locations is selected by entering a numeral.

! <least significant byte> <most significant byte>

This command has the same effect as the :SYSTem:SREStore command. The setting time however is 300 μ s less. It is optimized for highest speed and does not comply with the SCPI syntax regulations. Exactly 3 bytes are transmitted including the '!' (which is the identifier of this command). With the last byte, EOI has to be activated as delimiter.

The memory location is binary-coded in the 2 bytes indicated.

3.5.15 TEST-System

This system contains the commands to execute the selftest routines (RAM?, ROM? and BATTERY?) as well as to directly manipulate the hardware modules (:TEST:DIRect). The selftests return a "0" if the test has been executed successfully, otherwise a value unequal to "0". All commands of this system do not have an *RST value.

Caution: *The commands under node :TEST:DIRect directly act on the respective hardware module circumventing any security mechanisms. They are provided for service purposes and should not be used by the user. Improper use of the commands may damage the module.*

Command	Parameter	Default Unit	Remark
:TEST			
:DIRect			
:ATTC	Subaddress, hex data string		
:DGEN	Subaddress, hex data string		
:DSYN0MUX	Subaddress, hex data string		
:DSYN1MUX	Subaddress, hex data string		
:FMOD	Subaddress, hex data string		
:FSIM1M	Subaddress, hex data string		
:FSIM2M	Subaddress, hex data string		
:IQCON	Subaddress, hex data string		
:IQMOD	Subaddress, hex data string		
:MCOD	Subaddress, hex data string		
:REFSS	Subaddress, hex data string		
:ROSC	Subaddress, hex data string		
:SUM	Subaddress, hex data string		
:FSIM?			Query only
:RAM?			Query only
:ROM?			Query only
:BATTERY			
[:RAM]?			Query only
:DGEN?			Query only

:TEST:DIRect

This node contains the commands directly acting on the respective hardware module circumventing any security mechanisms. The commands under this node have no short form.

:TEST:DIRect:ATTC Subaddress, hex data string

The command directly acts on module ATTC. A subaddress (0 or 1) must be indicated as a parameter. The data are indicated as a <string> (i.e., an ASCII character string enclosed in quotation marks) representing hexadecimal numbers. Thus characters 0 to 9 A to F may occur in the character string.

Example: `:TEST:DIR:ATTC 0, "0010AF1F"`

Query: `:TEST:DIR:ATTC? 0`

:TEST:DIRect:DGEN Subaddress, hex data string

The command acts on module DGEN. (cf. :TEST:DIR:ATTC)

:TEST:DIRect:DSYN0MUX Subaddress, hex data string

The command acts on module DSYN. (cf. :TEST:DIR:ATTC)

:TEST:DIRect:DSYN1MUX Subaddress, hex data string

The command acts on module DSYN. (cf. :TEST:DIR:ATTC)

:TEST:DIRect:FMOD Subaddress, hex data string

The command acts on module FMOD. (cf. :TEST:DIR:ATTC)

:TEST:DIRect:FSIM1M Subaddress, hex data string

The command acts on module FSIM1M (cf. :TEST:DIR:ATTC)

:TEST:DIRect:FSIM2M Subaddress, hex data string

The command acts on module FSIM2M (cf. :TEST:DIR:ATTC)

:TEST:DIRect:IQMOD Subaddress, hex data string

The command acts on module IQMOD. (cf. :TEST:DIR:ATTC)

:TEST:DIRect:IQCON Subaddress, hex data string

The command acts on module IQCON. (cf. :TEST:DIR:ATTC)

:TEST:DIRect:REFSS Subaddress, hex data string

The command acts on module REFSS. (cf. :TEST:DIR:ATTC)

:TEST:DIRect:ROSC Subaddress, hex data string

The command acts on module ROSC. (cf. :TEST:DIR:ATTC)

:TEST:DIRect:SUM Sub address, hex data string

The command acts on module SUM. (cf. :TEST:DIR:ATTC)

:TEST:FSIM Subaddress, hex data string

The command triggers a test of the Fading Simulator.

:TEST:RAM?

The command triggers a test of the RAM.

:TEST:ROM?

The command triggers a test of the EPROM.

:TEST:BATTery[:RAM]?

The command triggers a test of the RAM battery voltage. The voltage should be at least 2.5 V.

:TEST:BATTery:DGEN?

The command triggers a test of the battery voltage of the data generator.

3.5.16 TRIGger-System

The TRIGger system contains the commands to select the trigger source and to configure the external trigger socket. The suffix is only important for the SWEEP subsystem:

TRIGger1 = RF generator

TRIGger2 = LFGEN

The trigger system of the SMIQ is a simplified implementation of the SCPI trigger system. Compared to SCPI, the TRIGger system shows the following differences:

- No INITiate command, the instrument behaves as if INITiate:CONTinuous ON was set.
- There are several subsystems denoting the different parts of the instrument under TRIGger (SWEep, LIST, MSEQUence).

Further commands as to the trigger system of the SMIQ can be found in the ABORt system.

Command	Parameter	Default Unit	Remark
:TRIGger1 2			
[:SWEep]			
[:IMMediate]			no query
:SOURce	SINGle EXTernal AUTO		
:LIST			
[:IMMediate]			no query
:SOURce	SINGle EXTernal AUTO		
:MSEQUence			
[:IMMediate]			no query
:SOURce	SINGle EXTernal AUTO		
:SLOPe	POSitive NEGative		

:TRIGger1|2[:SWEep]

All commands to trigger a sweep are under this node. The settings here act on level and frequency sweeps for RF generator (TRIG1) and LF generator (TRIG2).

:TRIGger1|2[:SWEep][:IMMediate]

The command immediately starts a sweep. Which sweep is executed depends on the respective MODE setting, e.g. :SOURce:FREQuency:MODE SWEEp. The command corresponds to manual-control command EXECUTE SINGLE SWEEP. This command triggers an event and thus has no *RST value.

Example: :TRIG:SWE:IMM

:TRIGger1|2[:SWEep]:SOURce AUTO | SINGle | EXTernal

The command specifies the trigger source. The naming of the parameters directly corresponds to the different settings with manual control. SCPI uses other designations for the parameters the instrument accepts as well. These designations are to be preferred if compatibility is important. The following table provides an overview.

SMIQ designation	SCPI designation	Command with manual control
AUTO	IMMEDIATE	MODE AUTO
SINGLE	BUS	MODE SINGLE or STEP
EXTERNAL	EXTERNAL	MODE EXT TRIG SINGLE or EXT TRIG STEP

AUTO The trigger is free-running, i.e., the trigger requirement is permanently met. As soon as a sweep has been terminated, the next one is started.

SINGLE Triggering is effected by means of IEC-bus commands :TRIGger:SWEep :IMMEDIATE or *TRG. If :SOURCE:SWEep:MODE is set to STEP, a step, in the case of the AUTO setting a complete sweep, is executed.

EXTERNAL Triggering is effected from outside via the EXT.TRIG. socket or by the GET command via IEC/IEEE-bus (see annex A). The action triggered depends on the setting of the sweep mode as in the case of SINGLE.

Example: :TRIG:SWE:SOUR AUTO *RST value is SINGLE

:TRIGger:LIST

This node contains all commands to trigger a list in the LIST mode.

:TRIGger:LIST[:IMMEDIATE]

The command immediately starts the processing of a list of the LIST mode. It corresponds to command EXECUTE SINGLE MODE of the manual control in the LIST menu. This command is an event and thus has no *RST value.

Example: :TRIG:LIST:IMM

:TRIGger1|2:LIST:SOURCE AUTO | SINGLE | EXTERNAL | HOP

The command specifies the trigger source. The naming of the parameters corresponds to the one with sweep mode. SCPI uses other designations for the parameters the instrument accepts as well. These designations are to be preferred if compatibility is important. The following table provides an overview:

SMIQ designation	SCPI designation	Command with manual control
AUTO	IMMEDIATE	MODE AUTO
SINGLE	BUS	MODE SINGLE or STEP
EXTERNAL	EXTERNAL	MODE EXT TRIG SINGLE or EXT TRIG STEP
HOP	----	MODE HOP

AUTO The trigger is free-running, i.e., the trigger condition is permanently fulfilled. As soon as the list selected has been finished in the LIST mode, it is started anew.

SINGLE Triggering is executed by means of IEC-bus command :TRIGger:LIST :IMM. The list is executed once.

EXTERNAL Triggering is carried out from outside via the EXT.TRIG. socket or by the GET command via IEC/IEEE-bus (see annex A). The list is executed once

HOP Triggering is carried out from inside via control list (HOP bit is set; option SMIOB11 data generator). Only with LIST:MODE STEP.

Example: :TRIG:LIST:SOUR AUTO *RST value is SINGLE

:TRIGger:MSEquence

This node contains all commands to trigger a memory sequence. The commands are only valid for TRIGger1.

:TRIGger:MSEquence[:IMMediate]

The command immediately starts a memory sequence. It corresponds to the EXECUTE SINGLE MODE command of the manual control in the MEMORY SEQUENCE menu. This command is an event and thus has no *RST value.

Example: :TRIG:MSEQ:IMM

:TRIGger:MSEquence:SOURce AUTO | SINGle | EXTernal

The command specifies the trigger source (cf. :TRIGger:SWEEP:SOURce)

Example: :TRIG:MSEQ:SOUR AUTO *RST value is SINGLE

:TRIGger:SLOPe POSitive | NEGative

The command indicates whether the external trigger input only responds to the positive, the negative or to both edges of the trigger signal. The command acts on TRIGger:SWEEP, TRIGger:LIST and TRIGger:MSEquence. The pulse generator has an own trigger input and thus also an own SLOPe command. *RST value is POSitiv

Example: :TRIG:SLOP NEG

3.5.17 UNIT-System

This system contains the commands specifying which units are valid if no unit is indicated in a command. These settings are valid for the entire instrument.

Command	Parameter	Default Unit	Remark
:UNIT			
:ANGLE	DEGRee DEGREE RADian		
:POWER	DBM DBW DBMW DBUW DBV DBMV DBUV V		

:UNIT:ANGLE DEGRee | DEGREE | RADian

The command indicates the unit for angles.

*RST value is RADian

Example: :UNIT:ANGL DEGR

:UNIT:POWER DBM | DBW | DBMW | DBUW | DBV | DBMV | DBUV | V

The command indicates the unit for power.

*RST value is DBM

Example: :UNIT:POW V

3.6 Instrument Model and Command Processing

The instrument model shown in Fig. 3-2 has been made viewed from the standpoint of the servicing of IEC-bus commands. The individual components work independently of each other and simultaneously. They communicate by means of so-called "messages".

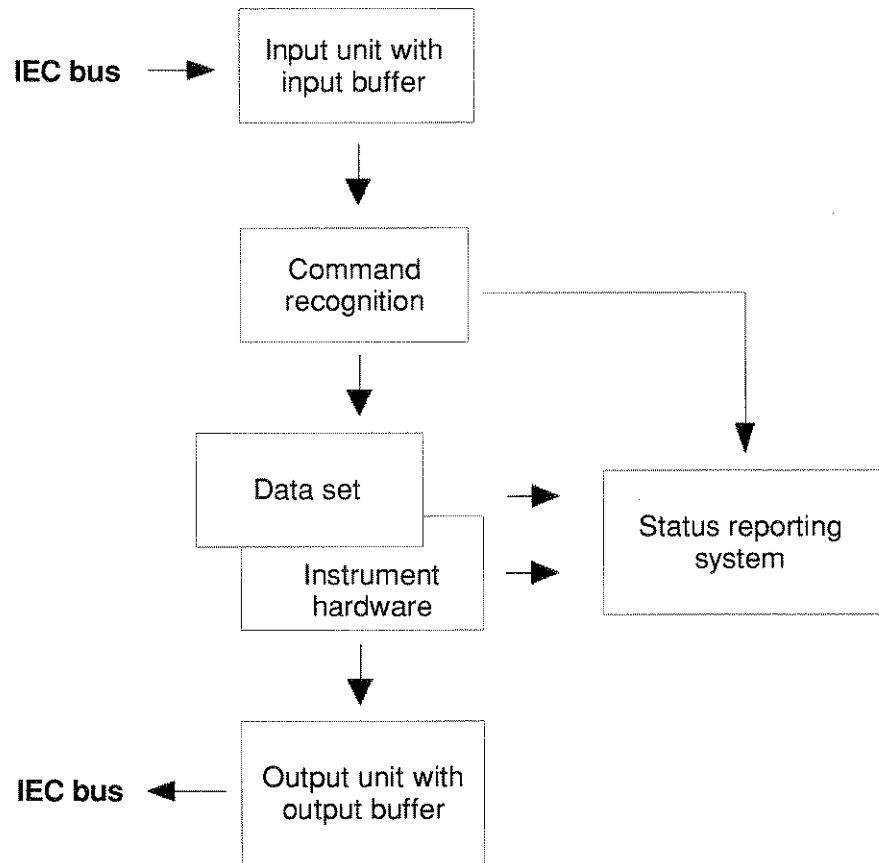

Fig. 3-2 Instrument model in the case of remote control by means of the IEC bus

3.6.1 Input Unit

The input unit receives commands character by character from the IEC bus and collects them in the input buffer. The input buffer has a size of 1024 characters. The input unit sends a message to the command recognition as soon as the input buffer is full or as soon as it receives a delimiter, <PROGRAM MESSAGE TERMINATOR>, as defined in IEEE 488.2, or the interface message DCL.

If the input buffer is full, the IEC-bus traffic is stopped and the data received up to then are processed. Subsequently the IEC-bus traffic is continued. If, however, the buffer is not yet full when receiving the delimiter, the input unit can already receive the next command during command recognition and execution. The receipt of a DCL clears the input buffer and immediately initiates a message to the command recognition.

3.6.2 Command Recognition

The command recognition analyses the data received from the input unit. It proceeds in the order in which it receives the data. Only a DCL is serviced with priority, a GET (Group Execute Trigger), e.g., is only executed after the commands received before as well. Each recognized command is immediately transferred to the data set but without being executed there at once.

Syntactical errors in the command are recognized here and supplied to the status reporting system. The rest of a command line after a syntax error is analyzed further if possible and serviced.

If the command recognition recognizes a delimiter or a DCL, it requests the data set to set the commands in the instrument hardware as well now. Subsequently it is immediately prepared to process commands again. This means for the command servicing that further commands can already be serviced while the hardware is still being set ("overlapping execution").

3.6.3 Data Set and Instrument Hardware

Here the expression "instrument hardware" denotes the part of the instrument fulfilling the actual instrument function - signal generation, measurement etc. The controller is not included.

The data set is a detailed reproduction of the instrument hardware in the software.

IEC-bus setting commands lead to an alteration in the data set. The data set management enters the new values (e.g. frequency) into the data set, however, only passes them on to the hardware when requested by the command recognition. As this is always only effected at the end of a command line, the order of the setting commands in the command line is not relevant.

The data are only checked for their compatibility among each other and with the instrument hardware immediately before they are transmitted to the instrument hardware. If the detection is made that an execution is not possible, an "execution error" is signaled to the status reporting system. All alterations of the data set are canceled, the instrument hardware is not reset. Due to the delayed checking and hardware setting, however, it is permissible to set impermissible instrument states within one command line for a short period of time without this leading to an error message (example: simultaneous activation of FM and PM). At the end of the command line, however, a permissible instrument state must have been reached again.

Before passing on the data to the hardware, the settling bit in the STATus:OPERation register is set. The hardware executes the settings and resets the bit again as soon as the new state has settled. This fact can be used to synchronize command servicing.

IEC-bus queries induce the data set management to send the desired data to the output unit.

3.6.4 Status Reporting System

The status reporting system collects information on the instrument state and makes it available to the output unit on request. The exact structure and function are described in the next section.

3.6.5 Output Unit

The output unit collects the information requested by the controller, which it receives from the data set management. It processes it according to the SCPI rules and makes it available in the output buffer. The output buffer has a size of 1024 characters. If the information requested is longer, it is made available "in portions" without this being recognized by the controller.

If the instrument is addressed as a talker without the output buffer containing data or awaiting data from the data set management, the output unit sends error message "Query UNTERMINATED" to the status reporting system. No data are sent on the IEC bus, the controller waits until it has reached its time limit. This behavior is specified by SCPI.

3.6.6 Command Sequence and Command Synchronization

What has been said above makes clear that all commands can potentially be carried out overlapping. Equally, setting commands within one command line are not absolutely serviced in the order in which they have been received.

In order to make sure that commands are actually carried out in a certain order, each command must be sent in a separate command line, that is to say, with a separate IBWRT()-call.

In order to prevent an overlapping execution of commands, one of commands *OPC, *OPC? or *WAI must be used. All three commands cause a certain action only to be carried out after the hardware has been set and has settled. By a suitable programming, the controller can be forced to wait for the respective action to occur (cf. table 3-3).

Table 3-3 Synchronization with *OPC, *OPC? and *WAI

Com-mand	Action after the hardware has settled	Programming the controller
*OPC	Setting the operation-complete bit in the ESR	- Setting bit 0 in the ESE - Setting bit 5 in the SRE - Waiting for service request (SRQ)
*OPC?	Writing a "1" into the output buffer	Addressing the instrument as a talker
*WAI	The next command is executed only after having processed all of the preceeding commands.	Sending the next command

An example as to command synchronization can be found in annex D "Program Examples".

3.7 Status Reporting System

The status reporting system (cf. Fig. 3-4) stores all information on the present operating state of the instrument, e.g. that the instrument presently carries out an AUTORANGE and on errors which have occurred. This information is stored in the status registers and in the error queue. The status registers and the error queue can be queried via IEC bus.

The information is of a hierarchical structure. The register status byte (STB) defined in IEEE 488.2 and its associated mask register service request enable (SRE) form the uppermost level. The STB receives its information from the standard event status register (ESR) which is also defined in IEEE 488.2 with the associated mask register standard event status enable (ESE) and registers STATus:OPERation and STATus:QUESTionable which are defined by SCPI and contain detailed information on the instrument.

The IST flag ("Individual STatus") and the parallel poll enable register (PPE) allocated to it are also part of the status reporting system. The IST flag, like the SRQ, combines the entire instrument status in a single bit. The PPE fulfills an analog function for the IST flag as the SRE for the service request.

The output buffer contains the messages the instrument returns to the controller. It is not part of the status reporting system but determines the value of the MAV bit in the STB and thus is represented in Fig. 3-4.

3.7.1 Structure of an SCPI Status Register

Each SCPI register consists of 5 parts which each have a width of 16 bits and have different functions (cf. Fig. 3-3). The individual bits are independent of each other, i.e. each hardware status is assigned a bit number which is valid for all five parts. For example, bit 3 of the STATus:OPERation register is assigned to the hardware status "wait for trigger" in all five parts. Bit 15 (the most significant bit) is set to zero for all parts. Thus the contents of the register parts can be processed by the controller as positive integer.

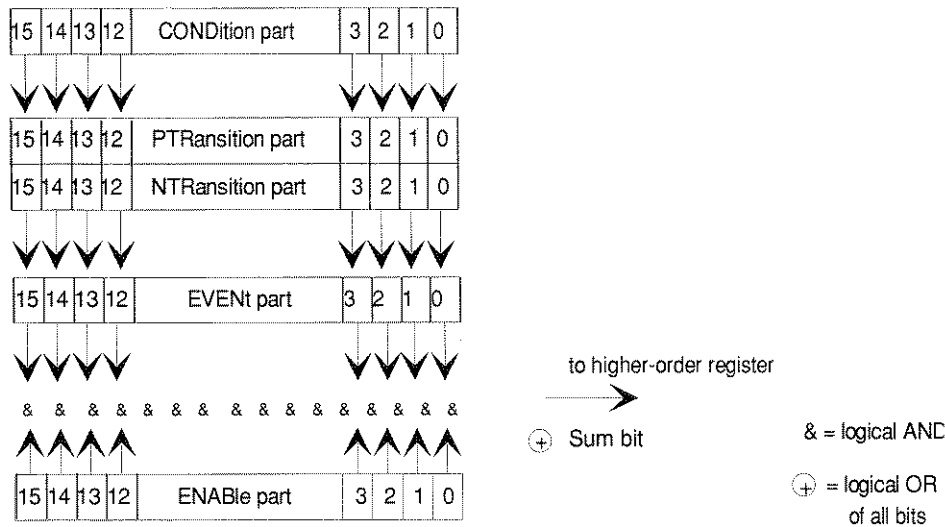

Fig. 3-3 The status -register model

- CONDition part** The CONDition part is directly written into by the hardware or the sum bit of the next lower register. Its contents reflects the current instrument status. This register part can only be read, but not written into or cleared. Its contents is not affected by reading.
- PTRansition part** The Positive-TRansition part acts as an edge detector. When a bit of the CONDition part is changed from 0 to 1, the associated PTR bit decides whether the EVENT bit is set to 1.
 PTR bit =1: the EVENT bit is set.
 PTR bit =0: the EVENT bit is not set.
 This part can be written into and read at will. Its contents is not affected by reading.
- NTRansition part** The Negative-TRansition part also acts as an edge detector. When a bit of the CONDition part is changed from 1 to 0, the associated NTR bit decides whether the EVENT bit is set to 1.
 NTR bit =1: the EVENT bit is set.
 NTR bit =0: the EVENT bit is not set.
 This part can be written into and read at will. Its contents is not affected by reading.
 With these two edge register parts the user can define which state transition of the condition part (none, 0 to 1, 1 to 0 or both) is stored in the EVENT part.
- EVENT part** The EVENT part indicates whether an event has occurred since the last reading, it is the "memory" of the condition part. It only indicates events passed on by the edge filters. It is permanently updated by the instrument. This part can only be read by the user. During reading, its contents is set to zero. In linguistic usage this part is often equated with the entire register.
- ENABLE part** The ENABLE part determines whether the associated EVENT bit contributes to the sum bit (cf. below). Each bit of the EVENT part is ANDed with the associated ENABLE bit (symbol '&'). The results of all logical operations of this part are passed on to the sum bit via an OR function (symbol '+').
 ENAB bit =0: the associated EVENT bit does not contribute to the sum bit
 ENAB bit =1: if the associated EVENT bit is "1", the sum bit is set to "1" as well.
 This part can be written into and read by the user at will. Its contents is not affected by reading.
- Sum bit** As indicated above, the sum bit is obtained from the EVENT and ENABLE part for each register. The result is then entered into a bit of the CONDition part of the higher-order register.
 The instrument automatically generates the sum bit for each register. Thus an event, e.g. a PLL that has not locked, can lead to a service request throughout all levels of the hierarchy.

Note: *The service request enable register SRE defined in IEEE 488.2 can be taken as ENABLE part of the STB if the STB is structured according to SCPI. By analogy, the ESE can be taken as the ENABLE part of the ESR.*

3.7.2 Overview of the Status Registers

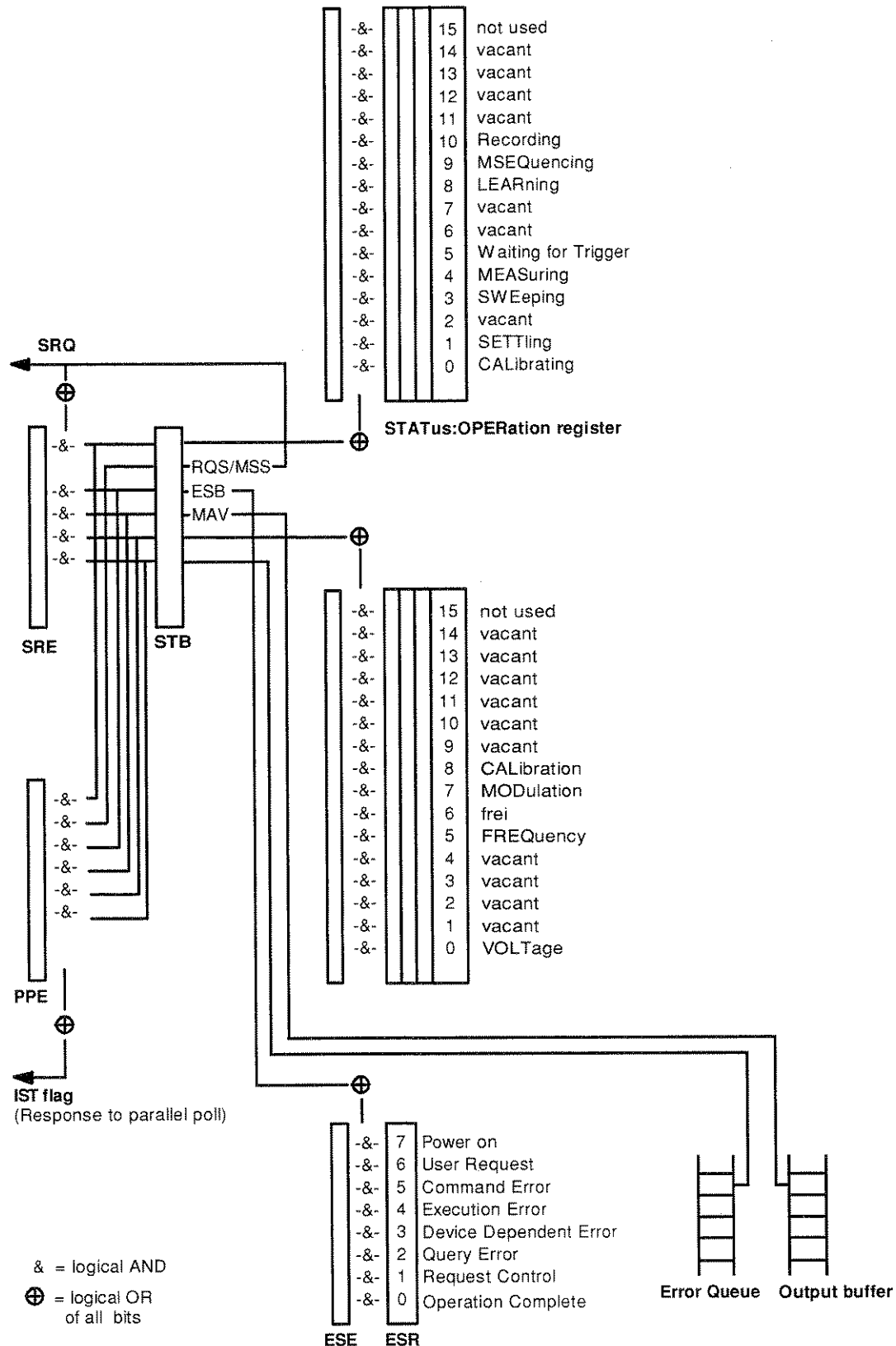

Fig. 3-4 Overview of the status register

3.7.3 Description of the Status Registers

3.7.3.1 Status Byte (STB) and Service Request Enable Register (SRE)

The STB is already defined in IEEE 488.2. It provides a rough overview of the instrument status by collecting the pieces of information of the lower registers. It can thus be compared with the CONDition part of an SCPI register and assumes the highest level within the SCPI hierarchy. A special feature is that bit 6 acts as the sum bit of the remaining bits of the status byte.

The STATUS BYTE is read out using the command ****STB?** or a serial poll.

The STB implies the SRE. It corresponds to the ENABLE part of the SCPI registers as to its function. Each bit of the STB is assigned a bit in the SRE. Bit 6 of the SRE is ignored. If a bit is set in the SRE and the associated bit in the STB changes from 0 to 1, a Service Request (SRQ) is generated on the IEC bus, which triggers an interrupt in the controller if this is appropriately configured and can be further processed there.

The SRE can be set using command ****SRE** and read using ****SRE?**.

Table 3-4 Meaning of the bits used in the status byte

Bit no.	Meaning
2	<p>Error Queue not empty</p> <p>The bit is set when an entry is made in the error queue. If this bit is enabled by the SRE, each entry of the error queue generates a Service Request. Thus an error can be recognized and specified in greater detail by polling the error queue. The poll provides an informative error message. This procedure is to be recommended since it considerably reduces the problems involved with IEC-bus control.</p>
3	<p>QUESTIONable status sum bit</p> <p>The bit is set if an EVENT bit is set in the QUESTIONable status register and the associated ENABLE bit is set to 1. A set bit indicates a questionable instrument status, which can be specified in greater detail by polling the QUESTIONable status register.</p>
4	<p>MAV-Bit (Message AVailable)</p> <p>The bit is set if a message is available in the output buffer which can be read. This bit can be used to enable data to be automatically read from the instrument to the controller (cf. annex D, program examples).</p>
5	<p>ESB bit</p> <p>Sum bit of the event status register. It is set if one of the bits in the event status register is set and enabled in the event status enable register. Setting of this bit implies a serious error which can be specified in greater detail by polling the event status register.</p>
6	<p>MSS-Bit (Master Status Summary bit)</p> <p>The bit is set if the instrument triggers a service request. This is the case if one of the other bits of this register is set together with its mask bit in the service request enable register SRE.</p>
7	<p>OPERation status register sum bit</p> <p>The bit is set if an EVENT bit is set in the OPERation status register and the associated ENABLE bit is set to 1. A set bit indicates that the instrument is just performing an action. The type of action can be determined by polling the OPERation status register.</p>

3.7.3.2 IST Flag and Parallel Poll Enable Register (PPE)

By analogy with the SRQ, the IST flag combines the entire status information in a single bit. It can be queried by means of a parallel poll or using command "*IST?".

The parallel poll enable register (PPE) determines which bits of the STB contribute to the IST flag. The bits of the STB are ANDed with the corresponding bits of the PPE, with bit 6 being used as well in contrast to the SRE. The Ist flag results from the ORing of all results. The PPE can be set using commands "*PRE" and read using command "*PRE?".

3.7.3.3 Event Status Register (ESR) and Event Status Enable Register (ESE)

The ESR is already defined in IEEE 488.2. It can be compared with the EVENT part of an SCPI register. The event status register can be read out using command "*ESR?".

The ESE is the associated ENABLE part. It can be set using command "*ESE" and read using command "*ESE?".

Table 3-5 Meaning of the bits used in the event status register

Bit No.	Meaning
0	Operation Complete This bit is set on receipt of the command "OPC exactly when all previous commands have been executed.
2	Query Error This bit is set if either the controller wants to read data from the instrument without having sent a query, or if it does not fetch requested data and sends new instructions to the instrument instead. The cause is often a query which is faulty and hence cannot be executed.
3	Device-dependent Error This bit is set if a device-dependent error occurs. An error message with a number between -300 and -399 or a positive error number, which denotes the error in greater detail, is entered into the error queue (cf. annex B, Error Messages).
4	Execution Error This bit is set if a received command is syntactically correct, however, cannot be performed for other reasons. An error message with a number between -200 and -300, which denotes the error in greater detail, is entered into the error queue (cf. annex B, Error Messages).
5	Command Error This bit is set if a command which is undefined or syntactically incorrect is received. An error message with a number between -100 and -200, which denotes the error in greater detail, is entered into the error queue (cf. annex B, Error Messages).
6	User Request This bit is set on pressing the LOCAL key, i.e., when the instrument is switched over to manual control.
7	Power On (supply voltage on) This bit is set on switching on the instrument.

3.7.3.4 STATus:OPERation Register

In the CONDition part, this register contains information on which actions the instrument is being executing or, in the EVEnt part, information on which actions the instrument has executed since the last reading. It can be read using commands "STATus:OPERation:CONDition?" or "STATus:OPERation [:EVEnt]?"..

Table 3-6 Meaning of the bits used in the STATus:OPERation register

Bit-No.	Meaning
0	CALibrating This bit is set as long as the instrument is performing a calibration.
1	SETTling This bit is set as long as the new status is settling after a setting command. It is only set if the settling time is longer than the command processing time.
3	SWEeping This bit is set while the instrument is performing a sweep.
4	MEASuring This bit is set while the instrument is performing a measurement.
5	WAIT for TRIGGER This bit is set as long as the instrument is waiting for a trigger event.
8	LEARning This bit is set while the instrument is "learning" a list.
9	MSEQuencing This bit is set while the instrument is performing a memory sequence.
10	RECOrding This bit is set while the instrument is recording external data via the DATA input.

3.7.3.5 STATus:QUESTionable Register

This register contains information on questionable instrument states. They can occur, e.g. if the instrument is operated out of its specifications. It can be queried using commands "STATus:QUESTionable:CONDition?" or "STATus:QUESTionable[:EVENT]?".

Table 3-7 Meaning of the bits used in the STATus:QUESTionable register

Bit-No.	Meaning
0	<p>VOLTage</p> <p>This bit is set if the voltage at an output connector is not correct, if the voltage is above or below the specified limit values, if the level limit has responded, if the overvoltage protection has responded.</p>
5	<p>FREQuency</p> <p>The bit is set if a frequency at the RF output is not correct or if it is lower or higher than the specified values</p>
7	<p>MODulation</p> <p>The bit is set if a modulation is not correct or is operated outside the specifications.</p>
8	<p>CALibration</p> <p>The bit is set if a calibration is not performed properly.</p>

3.7.4 Application of the Status Reporting Systems

In order to be able to effectively use the status reporting system, the information contained there must be transmitted to the controller and further processed there. There are several methods which are represented in the following. Detailed program examples are to be found in annex D, Program Examples.

3.7.4.1 Service Request, Making Use of the Hierarchy Structure

Under certain circumstances, the instrument can send a service request (SRQ) to the controller. Usually this service request initiates an interrupt at the controller, to which the control program can react with corresponding actions. As evident from Fig. 3.4, an SRQ is always initiated if one or several of bits 2, 3, 4, 5 or 7 of the status byte are set and enabled in the SRE. Each of these bits combines the information of a further register, the error queue or the output buffer. The corresponding setting of the ENABLE parts of the status registers can achieve that arbitrary bits in an arbitrary status register initiate an SRQ. In order to make use of the possibilities of the service request, all bits should be set to "1" in enable registers SRE and ESE.

Examples (cf. Fig. 3.4, and Program Examples, annex D as well):

Use of command "*OPC" to generate an SRQ

- Set bit 0 in the ESE (Operation Complete)
- Set bit 5 in the SRE (ESB)

After its settings have been completed, the instrument generates an SRQ.

Indication of the end of a sweep by means of an SRQ with the controller

- Set bit 7 in the SRE (sum bit of the STATUS:OPERation register)
- Set bit 3 (sweeping) in the STATUS:OPERation:ENABLE.
- Set bit 3 in the STATUS:OPERation:NTRansition so as to make sure that the transition of sweeping bit 3 from 1 to 0 (sweep end) is recorded in the EVENT part.

After a sweep has been completed, the instrument generates an SRQ.

The SRQ is the only possibility for the instrument to become active on its own. Each controller program should set the instrument such that a service request is initiated in the case of malfunction. The program should react appropriately to the service request. A detailed example for a service request routine is to be found in annex D, Program Examples.

3.7.4.2 Serial Poll

In a serial poll, just as with command "*STB", the status byte of an instrument is queried. However, the query is realized via interface messages and is thus clearly faster. The serial-poll method has already been defined in IEEE 488.1 and used to be the only standard possibility for different instruments to poll the status byte. The method also works with instruments which do not adhere to SCPI or IEEE 488.2.

The quick-BASIC command for executing a serial poll is "IBRSP ()". Serial poll is mainly used to obtain a fast overview of the state of several instruments connected to the IEC bus.

3.7.4.3 Parallel Poll

In a parallel poll, up to eight instruments are simultaneously requested by the controller by means of a single command to transmit 1 bit of information each on the data lines, i.e., to set the data line allocated to each instrument to logically "0" or "1". By analogy to the SRE register which determines under which conditions an SRQ is generated, there is a parallel poll enable register (PPE) which is ANDed with the STB bit by bit as well considering bit 6. The results are ORed, the result is then sent (possibly inverted) as a response in the parallel poll of the controller. The result can also be queried without parallel poll by means of command "*IST".

The instrument first has to be set for the parallel poll using quick-BASIC command "IBPPC()". This command allocates a data line to the instrument and determines whether the response is to be inverted. The parallel poll itself is executed using "IBRPP()".

The parallel-poll method is mainly used in order to quickly find out after an SRQ which instrument has sent the service request if there are many instruments connected to the IEC bus. To this effect, SRE and PPE must be set to the same value. A detailed example as to the parallel poll is to be found in annex D, Program Examples.

3.7.4.4 Query by Means of Commands

Each part of every status register can be read by means of queries. The individual commands are indicated in the detailed description of the registers. What is returned is always a number which represents the bit pattern of the register queried. Evaluating this number is effected by the controller program.

Queries are usually used after an SRQ in order to obtain more detailed information on the cause of the SRQ.

3.7.4.5 Error Queue Query

Each error state in the instrument leads to an entry in the error queue. The entries of the error queue are detailed plain-text error messages which can be looked at in the ERROR menu via manual control or queried via the IEC bus using command "SYSTem:ERRor?". Each call of "SYSTem:ERRor?" provides one entry from the error queue. If no error messages are stored there any more, the instrument responds with 0, "No error"

The error queue should be queried after every SRQ in the controller program as the entries describe the cause of an error more precisely than the status registers. Especially in the test phase of a controller program the error queue should be queried regularly since faulty commands from the controller to the instrument are recorded there as well.

3.7.5 Resetting Values of the Status Reporting Systems

Table 3-8 comprises the different commands and events causing the status reporting system to be reset. None of the commands, except for *RST and SYSTem:PRESet influences the functional instrument settings. In particular, DCL does not change the instrument settings.

Table 3-8 Resetting instrument functions

Event	Switching on supply voltage		DCL,SDC (Device Clear, Selected Device Clear)	*RST or SYSTem:PRESet	STATus:PRESet	*CLS
	Power-On-Status-Clear					
	0	1				
Clear STB,ESR	—	yes	—	—	—	yes
Clear SRE,ESE	—	yes	—	—	—	—
Clear PPE	—	yes	—	—	—	—
Clear EVENT parts of the registers	—	yes	—	—	—	yes
Clear ENABle parts of all OPERation-and QUESTionable registers, Fill ENABle parts of all other registers with "1".	—	yes	—	—	yes	—
Fill PTRansition parts with "1" Clear NTRansition parts	—	yes	—	—	yes	—
Clear error queue	yes	yes	—	—	—	yes
Clear output buffer	yes	yes	yes	1)	1)	1)
Clear command processing and input buffer	yes	yes	yes	—	—	—

1) Every command being the first in a command line, i.e. immediately following a <PROGRAM MESSAGE TERMINATOR> clears the output buffer.

3.8 Fast Restore Mode

The Fast Restore mode is available with **SMIQ03A** and units that are equipped with option Fast CPU for **SMIQ SM-B50**. Device settings can be saved and recalled very quickly via the IEC/IEEE bus using the commands described below. 1000 memory locations are available.

In contrast to the SAVE/RECALL function, not the unit parameters but only the setting data of the modules are stored in the Fast Restore mode. RESTORE by means of the ':SYSTEM:SREStore' or '!..' command has an immediate effect on the module. The database (which stores all entries and delivers the display data) is bypassed. This allows a very high setup speed.

Commands:

:SYSTEM:SSAVe 1...1000

This command saves the current device setting at the memory location indicated.

:SYSTEM:SREStore 1...1000

This command loads a device status that was stored using the :SYSTEM:SSAVe command (RESTORE). One of 1000 available memory locations is selected by entering a numeral.

! <least significant byte> <most significant byte>

This command has the same effect as the :SYSTEM:SREStore command. The setting time however is 300 μ s less. It is optimized for highest speed and does not comply with the SCPI syntax regulations. Exactly 3 bytes are transmitted including the '!' (which is the identifier of this command). With the last byte, EOI has to be activated as delimiter.

The memory location is binary-coded in the 2 bytes indicated.

Example:

RESTORE at memory location 268 (-> 010C hex) corresponds to the following binary command:

```
0010 0001 0000 1100 0000 0001
  '!'      hex 0C      hex 01
```

Binary-coded bytes can usually not be written as printable ASCII characters.

When programmed in C, the above command has the following form:

```
char sendstring[3] = {'!', 0x0C, 0x01}
```

In BASIC, the command string to be output is as follows:

```
'!' + CHR$(12) + CHR$(1)
```

(The arguments for CHR\$ are decimal numbers, therefore 12 for 0C hex.)

Since binary-coded bytes may also have the value of the LF (line feed) character which is interpreted as a delimiter, switch over to 'only EOI' as delimiter by selecting ':SYSTEM:COMMunicate:GPIB:LTERminator EOI' prior to using this command.

Call-up and termination of operating mode

After a RESTORE, the database does no longer reflect the device setting which means that

- the displayed values are no longer relevant,
- the desired result is not obtained by a query of setup values.
- normal setting commands may not be executed properly (see below 'Alternative ...')

It is therefore recommended to use the *RST command to terminate this operating mode. The database and the device setting will match again after execution of the *RST command.

No other commands are required to activate or deactivate this mode.

- Note:**
- *Since the module setting depends on the temperature of the unit, any temperature variation of more than 5°C should be avoided between storage and call-up to ensure the accuracy of the unit.*
 - *If the mechanically switched attenuator is switched over due to a RESTORE command, the setting time increases by 15 ms. This can be avoided by setting one of the two functions for interruption-free level setting (:OUTPut:AMODE FIXed or ELECTronic) prior to storing the setting.*

Effects on device settings:

The Fast Restore commands have an effect on almost all device settings (see table).

Device settings stored and called up by Fast Restore:	Device settings not stored or called up by Fast Restore:
<ul style="list-style-type: none"> • Frequency incl. reference oscillator • Level - incl. mech. switched attenuator, <ul style="list-style-type: none"> - incl. user correction, - incl. ALC modes • Analog modulation • Vector modulation • Switch-on/off of digital modulation • LF generator and LF output 	<ul style="list-style-type: none"> • Settings of baseband signal of digital modulation and digital standard • Functions not regarding the RF output signal, eg commands under :SYSTem:... (except for SYSTem:PRESet) or :UNIT:... • Sweep • List mode • Memory sequence

Alternative use with other IEC/IEEE-bus commands:

The alternative use of the RESTORE commands (' :SYSTem:SREStore' or '!...') and normal IEC/IEEE-bus commands is

- useful in case of digital modulation:
First, the baseband signal is configured by means of normal commands and digital modulation is switched on. Then, digital modulation can be switched on/off by means of the RESTORE commands.
- possible for all commands that do not regard the RF output signal (eg :SYSTem:..., :UNIT:...),
- normally not possible for all the functions listed in the left column of the above table. In case of doubt, we recommend testing.

4 Maintenance and Troubleshooting

The instrument does not need a periodic maintenance. What is necessary is essentially the cleaning of the instrument. However, it is recommended to check the rated data from time to time.

4.1 Maintenance

4.1.1 Cleaning the Outside

The outside of the instrument is suitably cleaned using a soft, line-free dustcloth.

Caution! *Do not use solvents such as thinners, acetone and similar things in any case, because otherwise the front panel labeling or plastic parts will be damaged.*

4.1.2 Storage

The storage temperature range of the instrument is -40 to +70 degrees Celsius. If the instrument is to be stored for a longer period of time, it must be protected against dust.

4.2 Functional Test

The SMIQ carries out a selftest on switching on the instrument and permanently during operation. On switching on, the RAM and ROM contents are checked and the batteries of the non-volatile RAMs are tested. If an error is detected, this is indicated through a corresponding error message. The most important instrument functions are automatically monitored during operation.

If a faulty function is detected in the selftest, ERROR is displayed in the status line. To identify the error, the ERROR menu, in which the error messages are entered, can be called by pressing the [ERROR] key (cf. Chapter 2, Section "Error Messages").

The tests can additionally be called via the menu.

Access to the tests is offered by the UTILITIES - TEST menu.

Menu selection: UTILITIES - TEST

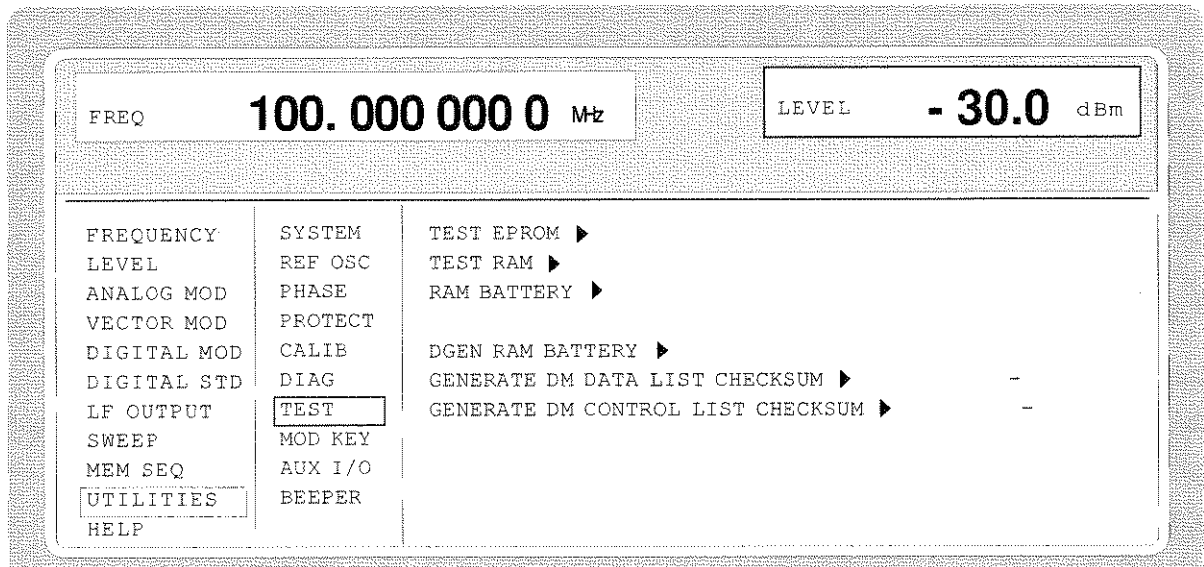

Fig 4-1 UTILITIES-TEST menu

- TEST EPROM ▶** Tests the EPROM. The test result is displayed in a window.
IEC/IEEE-bus-command :TEST:BATT:ROM?

- TEST RAM ▶** Tests the RAM. The test result is displayed in a window.
IEC/IEEE-bus-command :TEST:BATT:RAM?

- RAM BATTERY ▶** Tests the RAM battery. The test result is displayed in a window.
IEC/IEEE-bus-command :TEST:BATT:DGEN?

- DGEN RAM BATTERY ▶** Tests the RAM battery of the data generator. The test result is displayed in a window.
IEC/IEEE-bus-command :TEST:BATT:DGEN?

- GENERATE DM DATA LIST CHECKSUM ▶** Calculates the checksum of the active data list.
The following algorithm is applied:
The entries in the list are interpreted as binary numbers with a length of 32 bits. The most significant bit is on the left side. All 32-bit numbers are added modulo 2^{32} . The result is displayed in hexadecimal representation.

IEC/IEEE-bus-command :DIAG:DLIS:CHEC
:DIAG:DLIS:DATA?

- GENERATE DM CONTROL LIST CHECKSUM ▶** Calculates the checksum of the active control list. (algorithm see above).
IEC/IEEE-bus-command :DIAG:CLIS:CHEC
:DIAG:CLIS:DATA?

- TEST FSIM ▶** Tests the Fading Simulator. The test result is displayed in a window.
IEC/IEEE-bus-command :TEST:FSIM?

5 Performance Test

5.1 Test Utilities and Test Systems

5.1.1 Test Instruments and Utilities

Table 5-1 Test instruments and utilities

Item	Type of instrument	Specifications required	Suitable instrument	R&S order no.
1	Frequency counter (included in item 2)	1Hz to 3.3 GHz Resolution 0.1 Hz		
2	RF spectrum analyzer	100 Hz to 7 GHz synthesizer tuning, dynamic range >80 dB	FSEB20 FSEM20	1066.3010.20 1080.1505.20
3	Storage oscilloscope	100-M samples/s, averaging function		
4	Controller	Industrial standard PC/XT/AT with IEC-625 interface	PSM7	1064.1004.70
5	Signal generator of high spectral purity	0.1 MHz to 3.3 GHz SSB noise level <-126 dBc at 1GHz/20 kHz	SME06	1038.6002.06
6	Phase noise test system	Mixer: 10 MHz to 3.3 GHz Separating filter 2 MHz, preamplifier with a gain of approx. 30dB, input noise <2nV (1Hz), d.c. decoupling following mixer for oscilloscope		
7	Oscilloscope (in most cases included in item 3)	Bandwidth > 100 MHz, two channels with d.c. coupling		
8	RF power meter	5 kHz to 3.3 GHz	NRVS with NRV-Z51	1020.1809.02 0857.9004.02
9	Precision attenuator	Attenuation 0 to 120 dB, resolution 5 dB	RSG	1009.4505.02
10	Low-noise preamplifier	5 kHz to 3.3 GHz amplification > 20 dB, noise figure < 10 dB		
11	VSWR bridge	1 MHz to 3.3 GHz directivity > 40 dB	ZRC	1039.9492.55/52
12	D.c. voltage source	Setting range 0 to 10 V	NGMD35	0117.7127.02
13	R power amplifier	10 MHz to 3.3 GHz, Power > 1W		
14	Audio analyzer	Generator up to 100 kHz, level meter, distortion meter	UPD	1030.7500.04/05
15	Modulation analyzer	100 kHz to 3.3 GHz, AM, FM, PhiM, stereo coder, stereo decoder, distortion meter, weighting filter ITU-R, ITU-T	FMB with FMA-B1, FMA-B2, FMA-B3, FMA-B4	856.5005.52
16	Mixer	10 MHz to 3.3 GHz "high level"		
17	Pulse generator	Pulse repetition frequency up to 10 MHz, Level TTL	AFG	377.2100.02
18	Sinewave generator	10 Hz to 8 MHz, 1 V (Vpeak)	AMS, ADS, AFG	1013.0000.02, 1013.1494.02, 377.2100.02

Item	Type of instrument	Specifications required	Suitable instrument	R&S order no.
19	AC/DC voltmeter	10 Hz to 8 MHz	URE3	350.5315.03
20	Broadband FM demodulator	Delay line discriminator, input frequency 50 MHz, electrical length 15 m, demodulation bandwidth 10 MHz		
21	RF attenuator pad	D.c to 3.3 GHz, 3 dB	DNF	0272.4010.50
22	Lowpass filter	Attenuation up to 50 MHz < 1 dB at 100 MHz > 20 dB at 200 MHz > 40 dB		
23	Demodulator for digital modulations	Vector error measurement	FSEB20 with option FSE-B7	1066.3010.20 1066.4317.02
24	Arbitrary waveform generator	Two channels	ADS	1013.1494.02
25	Program for simulation of digital modulations	Generation of data for ARB generator	IQSIM-K	1013.1642.02
26	Frequency divider	500 to 1500 MHz		
27	Broadband demodulator for digital modulations	Error vector and FSK error measurements up to 3 MSymbols/s		

5.1.2 Test Systems

5.1.2.1 Standard Test System for Analog Modulations

Test equipment

- Modulation analyzer (Table 5-1, item 15)
- Oscilloscope (Table 5-1, item 7, only a few measurements)
- Frequency divider (Table 5-1, item 26, only a few measurements)

Test setup

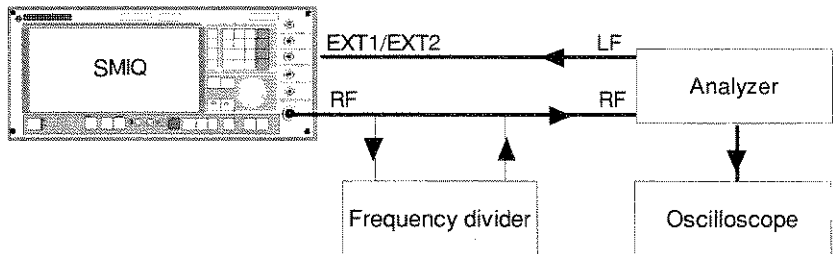

5.1.2.2 Test System for Analog Modulations with Audio Analyzer

Test equipment

- Modulation analyzer (Table 5-1, item 15)
- Audio analyzer (Table 5-1, item 14)

Test setup

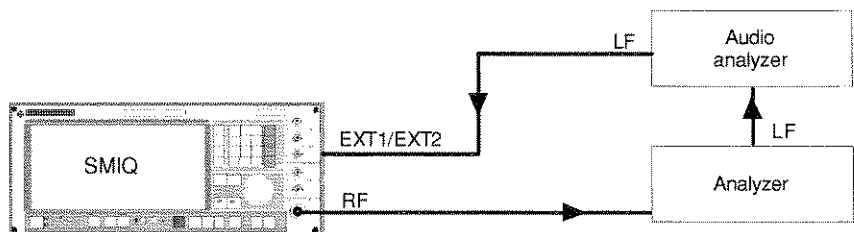

5.1.2.3 Test System for Broadband FM

Test equipment

- Second signal generator (Table 5-1, item 5)
- Mixer (Table 5-1, item 16)
- Sinewave generator (Table 5-1, item 18)
- AC voltmeter (Table 5-1, item 19)
- Broadband FM demodulator (Table 5-1, item 20)
- RF attenuator pad (Table 5-1, item 21)
- Lowpass filter (Table 5-1, item 22)

Test setup

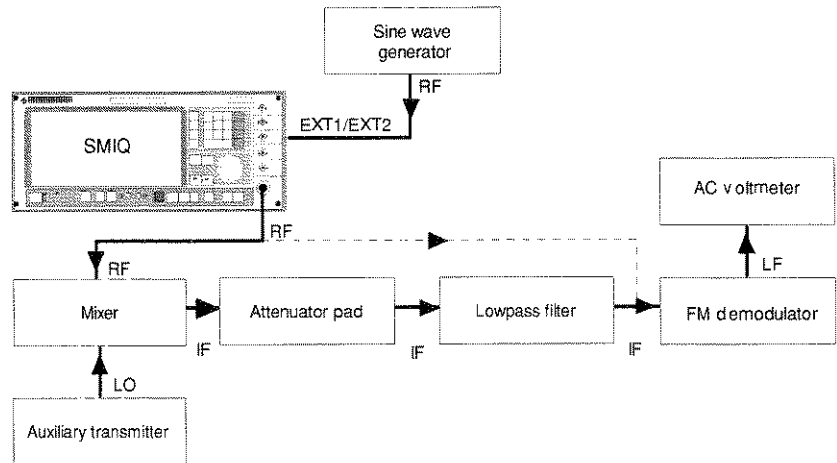

5.1.2.4 Test System for Pulse Modulation

Test equipment

- Second signal generator (Table 5-1, item 5)
- Oscilloscope (Table 5-1, item 7)
- Mixer (Table 5-1, item 16)
- Pulse generator (Table 5-1, item 17)
- RF attenuator pad (Table 5-1, item 21)
- Lowpass filter (Table 5-1, item 22)

Test setup

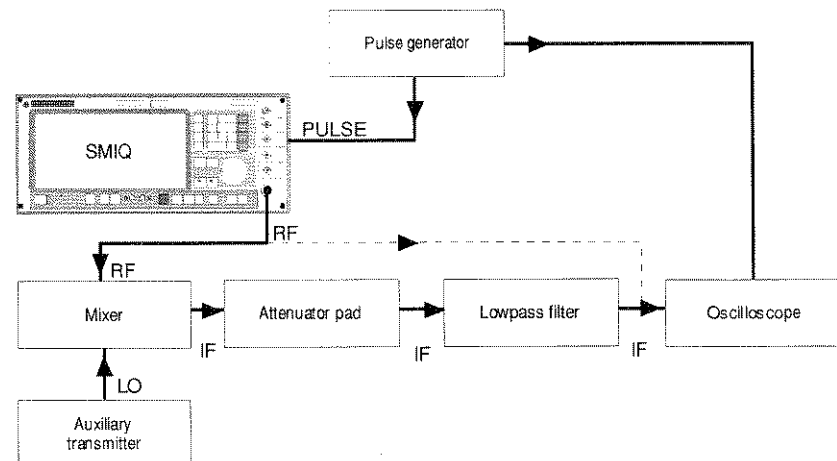

5.1.2.5 Test System for Vector Modulation

Test equipment

- Demodulator for digital modulation (Table 5-1, item 23)
- Arbitrary waveform generator (Table 5-1, item 24)
- Program for simulation of digital modulations (Table 5-1, item 25)
- Controller according to industrial standard (Table 5-1, item 4)

Test setup

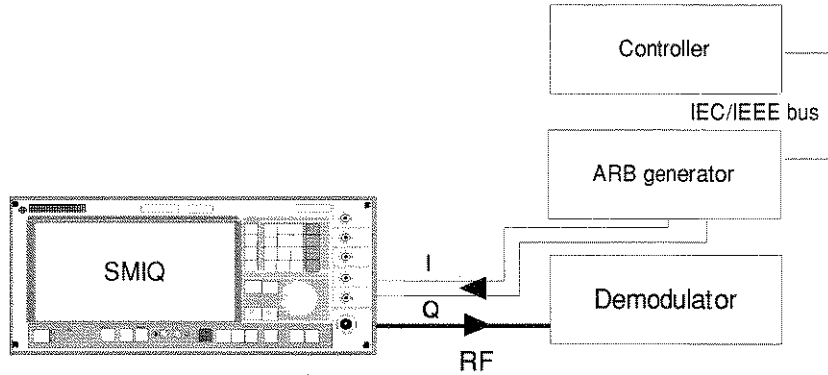

5.1.2.6 Test System for Settling Time

Test equipment

- Spectrum analyzer with video output (Table 5-1, item 2)
- Storage oscilloscope (Table 5-1, item 3)
- Controller (Table 5-1, item 4)

Test setup

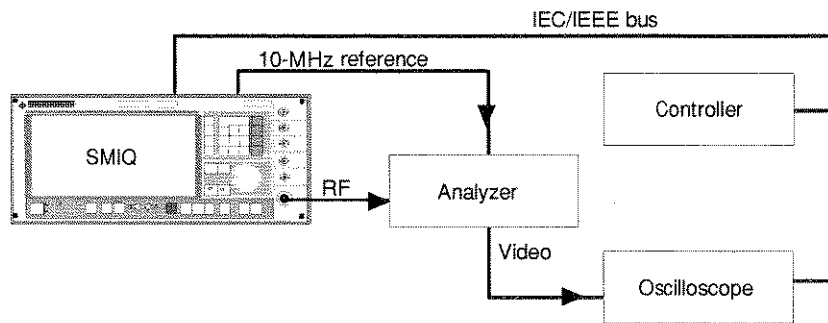

5.1.2.7 Test System for SSB Phase Noise

Test equipment

- Second signal generator (Table 5-1, item 5),
- Phase noise test system consisting of mixer with lowpass and preamplifier (Table 5-1, item 6),
- Oscilloscope (Table 5-1, item 7)
- Spectrum analyzer (Table 5-1, item 2).

Test setup

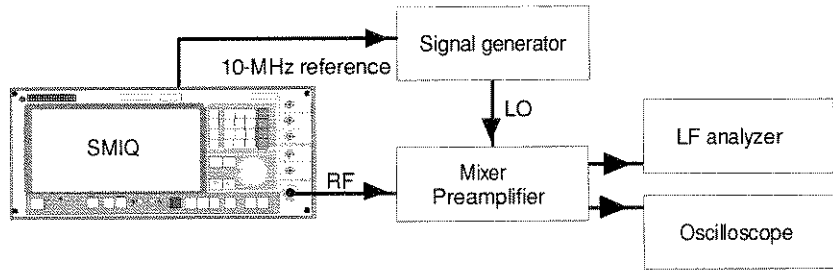

5.1.2.8 Test System for Output Impedance (VSWR).

Test equipment

- VSWR bridge (Table 5-1, item 11)
- Second signal generator (Table 5-1, item 5)
- Spectrum analyzer (Table 5-1, item 2)

Test setup

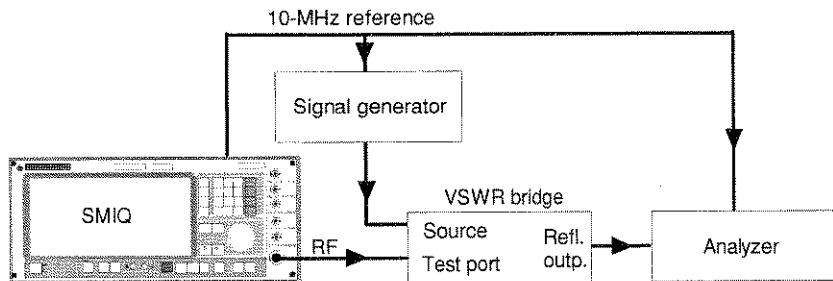

Note: The test port of the bridge has to be screwed directly to the test item.

5.1.2.9 Test System with Spectrum Analyzer for Fading Simulation

- Test equipment
- Arbitrary Waveform Generator (Table 5-1, item 24)
 - Spectrum analyzer (Table 5-1, item 2)

Test setup

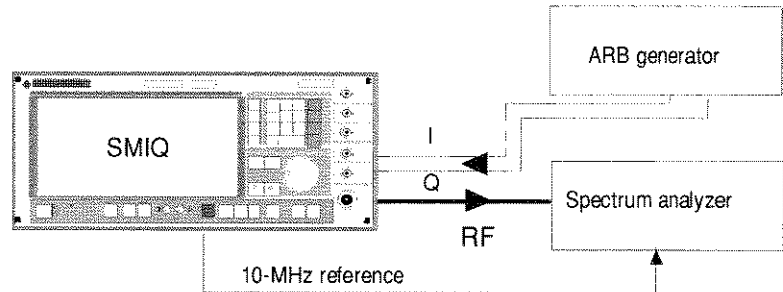

5.1.2.10 Test System with Sampling Oscilloscope for Fading Simulation

- Test equipment
- Arbitrary Waveform Generator (Table 5-1, item 3)
 - Sampling oscilloscope (Table 5-1, item 26)

Test setup

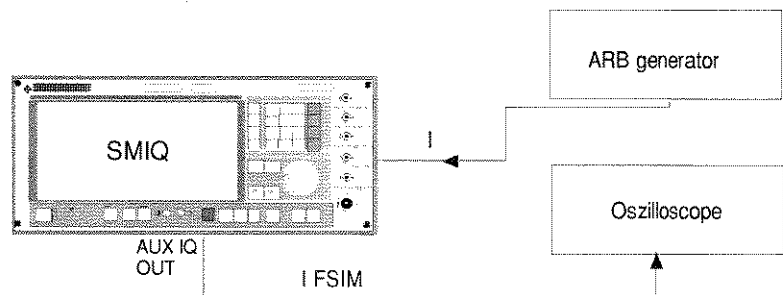

5.2 Preparation and Sampling Frequencies

The rated specifications of the generator are tested after the instrument has **warmed up** for at least **30 minutes** and all **internal calibrations** (see Section 2) have been carried out. This is the only way to make sure that the guaranteed data are observed. For all settings, a defined initial status must be set first by pressing the **PRESET key** in order to avoid faulty settings.

The following Sections describe the methods used for testing the rated specifications. The binding rated values are to be obtained from the data sheet.

Table 5-2 shows the sampling frequencies of the internal calibrations. In order to fully test the function of the instrument, we recommend measurements at these frequencies if no particular test frequencies are given.

Table 5-2 Sampling frequencies of the internal calibrations

General sampling frequencies

300 000.0 Hz*	10 000 000.0 Hz
500 000.0 Hz	15 000 000.0 Hz
1 000 000.0 Hz	20 000 000.0 Hz
2 000 000.0 Hz	25 000 000.0 Hz
3 000 000.0 Hz	50 000 000.0 Hz
5 000 000.0 Hz*	every 50MHz up to
5 000 000.1 Hz*	3300 000 000.0 Hz*
7 000 000.0 Hz	

Important *-sampling frequencies (range limits and frequencies 0.1 Hz above)

General range limits CW	450MHz, 1500MHz, 3000MHz, 3040MHz
General range limits VM	525MHz, 750MHz, 1200MHz, 1800MHz, 2500MHz
Oscillator changeover CW	1100MHz, 2200MHz
Oscillator changeover VM	800MHz, 1500MHz

5.3 Performance Test

5.3.1 Display and Keyboard

- Testing the display
- Switch on instrument.
 - ⇒ The basic menu is displayed after several seconds.
 - Rotate contrast control (left-hand potentiometer below the display).
 - ⇒ The contrast is varied from dark to bright.
 - Rotate brightness control (right-hand potentiometer).
 - ⇒ The brightness of the backlighting is varied.
- Testing the keyboard
- Press keys and check response at the display.

5.3.2 Frequency

5.3.2.1 Frequency Setting

- Test equipment Frequency counter (Table 5-1, item 1)
- Test method The frequency setting is checked using a frequency counter the reference frequency of which is synchronized with that of the SMIQ.
- Measurement
- SMIQ setting
 - test frequency unmodulated,
 - level 0 dBm.
 - ⇒ The values measured must be exact within the frame of the counter resolution.

Test frequencies recommended:

Test frequency CW	Module tested
839.1, 839.15, 839.5MHz	Digital synthesis
840 .. 940MHz in 10MHz steps	Step synthesis
800, 850, 1000, 1100, 1200, 1300, 1400, 1490MHz	Harmonics of summing loop
450.1, 750MHz	Divider and harmonic filter IQ converter
10, 449MHz	Output mixer IQ modulator
1501, 2000, 2500, 3300 MHz	Doubler with filter IQCON
Test frequencies VM, max. level	
500, 800, 1801, 2501MHz	Doubler with filter IQCON

5.3.2.2 Settling Time

Test system	see Section test systems
Test method	The spectrum analyzer is operated as an edge demodulator with a 0-Hz span. A controller transmits start and stop frequency via the IEC bus. The storage oscilloscope is connected to the video output of the analyzer and triggered by the positive edge on the EOI line of the IEC bus. If the controller switches over from start to stop frequency, the settling procedure is displayed on the screen of the storage oscilloscope.
Preparing the measurement	<ul style="list-style-type: none"> ➤ Synchronize the reference frequencies of SMIQ and analyzer. ➤ Establish IEC bus and RF connections. ➤ Connect storage oscilloscope to the video output of the analyzer. ➤ Apply trigger connection to the EOI line (pin 5) of the IEC bus. ➤ SMIQ settings <ul style="list-style-type: none"> - Stop frequency unmodulated - Level 0 dBm. ➤ Storage oscilloscope settings <ul style="list-style-type: none"> - Time base 5 ms/div, - Sensitivity corresponding to the video output of the analyzer - Trigger free-running with respect to calibration. ➤ Spectrum analyzer settings <ul style="list-style-type: none"> - Reference level 5 dBm, - Amplitude scale 1 dB/div, - Resolution bandwidth to 3 kHz, - Video bandwidth 100 kHz, - Span 10 kHz. ➤ Now reduce the center frequency of the analyzer, starting from the stop frequency, until the visible filter edge runs through the central point of the screen. ➤ The span can now be reduced to 0 Hz and the frequency scale can be calibrated at the (free-running) oscilloscope by means of 100-Hz steps at the SMIQ.
Measurement	<ul style="list-style-type: none"> ➤ Storage oscilloscope settings as above <ul style="list-style-type: none"> - Triggering externally by the positive edge at 1.5 V. ➤ Send the start frequency first and then the stop frequency from the controller. <ul style="list-style-type: none"> ⇒ The settling curve is displayed on the screen of the oscilloscope triggered externally. ➤ Repeat the measurement with exchanged start and stop frequencies.

(Settling time)

⇒ The measurement is to be made in the following steps in both directions:

Test	Setting	F1/MHz	F2/MHz
Step synthesis	CW	840	942
Digital synthesis	CW	1 350.2	1 351.4
Mixer	CW	1 099	5
Doubler, osc. change	CW	2201	1099
CW/VM synthesis, 3rd filter	CW	2999	3 001
1st/2nd filter	VM max. level, ALC mode table	751	1801
2nd/3rd filter	VM max. level, ALC mode table	1801	2601

Quick-Basic program for the controller

```

CLS
iecadresse% = 28
CALL IBFIND("DEV1", generator%)
CALL IBPAD(generator%, iecadresse%)
iecterm% = &HA '
CALL IBEOS(generator%, iecterm% + &H800)
CALL IBWRT(generator%, "POW 0dBm")
DO
  INPUT "Start frequency in MHz";F1$
  INPUT "Stop frequency in MHz";F2$
  DO
    CALL IBWRT(generator%, "FREQ" + F1$ + "MHz")
    PRINT "Frequency: ";F1$; "MHz"
    DO '
      kbd$ = INKEY$
      LOOP UNTIL LEN(kbd$)
      SWAP F1$, F2$
    LOOP UNTIL kbd$ = CHR$(27) '
    INPUT "repetition (y/n)"; w$
  LOOP UNTIL NOT UCASE$(w$) = "J"
END
    
```

IEC-bus address of SMIQ (28)
 Open DEV1 and obtain access number
 Set IEC-bus address of DEV1 to 28
 Set EOS to LINE FEED

wait for key

Exit using ESCAPE

5.3.3 Reference Frequency

Caution: Allow the SMIQ to warm up for at least 2 hours before measurement.

- Test equipment Frequency counter (Table 5-1, item 1)
- Test setup > Connect a calibrated frequency counter to output REF (socket at the rear).
- Measurement > Measure frequency.
 ⇒ The frequency deviation must not exceed the sum of the deviations resulting from the frequency error in the rated temperature range and from aging.

5.3.4 Spectral Purity

5.3.4.1 Harmonics Suppression/Harmonics

Test equipment	Spectrum analyzer (Table 5-1, item 2)
Test setup	<ul style="list-style-type: none"> ➤ Connect the spectrum analyzer to the RF output of the SMIQ
Measurement	<ul style="list-style-type: none"> ➤ SMIQ settings <ul style="list-style-type: none"> - Test frequencies according to Table 5-2, unmodulated. - Level according to Data Sheet. ➤ Analyzer settings <ul style="list-style-type: none"> - Reference level = test level + 10 dB, 10dB/div. - Span 300kHz, resolution 30kHz ➤ First, the level of the fundamental is measured as reference. Then signals are searched for at twice and three times the carrier frequency. Make sure not to overdrive the spectrum analyzer. <ul style="list-style-type: none"> ⇒ The harmonics level is the level of the harmonics found referred to the output signal of the test item (dBc = referred to the carrier).

5.3.4.2 Suppression of Nonharmonics

Test equipment and setup	as with harmonics suppression
Measurement	<ul style="list-style-type: none"> ➤ First the level of the output signal is measured as reference, then a signal is searched for at the sampling frequency. <ul style="list-style-type: none"> ⇒ The nonharmonics level is the level of the nonharmonics found referred to the output signal of the test item (dBc = referred to the carrier).
Recommended spectrum analyzer settings	<ul style="list-style-type: none"> ➤ - Span 0 Hz, - Resolution bandwidth 1 kHz, - Video bandwidth 30 Hz, - Sample detector ➤ Synchronize reference frequencies of analyzer and test item.

Note: *These values are rough values that are dependent on the analyzer used. The necessary suppression must be verified prior to the measurement.*

Nonharmonics of step synthesis with test level 5.1dBm, unmodulated

Setting at the SMIQ frequency in MHz	Searching at frequency in MHz
831.0	831.6896
832.7	833.3993
1044.5	1045.0988
1043.0	1043.5917
1139.6	1140.1181
1141.0	1141.5235
1457.5	1458.4174
1349.6	1350.5345
1444.0	1444.8264
1446.0	1446.8403
1430.5	1431.2519
1434.1	1434.8634

Nonharmonics of the summing loop with test level 5.1dBm, unmodulated

Setting at the SMIQ frequency in MHz	Searching at frequency in MHz
1412.9	1413.2
1305.4	1305.7
1197.9	1198.2
1090.4	1090.7
838.25	838.3676
380	380.4255
1495.59	1511.18
1354.0625	1368.3192
1354.0625	1382.5758

Nonharmonics IQMOD with test level 5.1dBm, unmodulated

SMIQ setting frequency in MHz	Searching at frequency in MHz
451	300, 600, 1200, 2400, 3000
449.9	600, 1200, 2400
225	600, 1200, 2400
70.0	600, 1200, 2400

Mixer nonharmonics output mixer IQMOD with test level 13dBm, unmodulated

SMIQ setting frequency in MHz	Searching at frequency in MHz
449	1053, 1951, 2849
449.9	1050.3, 600.4
225	1725
70.0	2190

Nonharmonics of IQ synthesis, with test level 2.1 dBm, VM max. level

SMIQ setting frequency in MHz	Searching at frequency in MHz
751	600
901	900
751	1051, 1351
1450	1750, 2050, 1150, 850
1800	2100
1801	1501, 3002
2150	1850, 2450
2500	2200
2501	2201
2900	2600, 2300
3200	2900, 3500
595	305
1	299
149	151
524	752,452
401	698

Nonharmonics of output mixer IQMOD, with test level 7 dBm, VM max. level

SMIQ setting frequency in MHz	Searching at frequency in MHz
580	660
749.99	900.02

Non-systematic nonharmonics

Measurement

- **SMIQ settings**
 - Test frequencies: 93, 520, 749, 751, 1799, 1801, 2499, 2501, 3300 MHz.
 - Test level 5.1dBm unmodulated and 2.1 dBm with vector modulation with maximum level.
- **Recommended analyzer settings:**
 - Sample detector
 - Searching far from the carrier:
 - Resolution bandwidth 30kHz
 - Video bandwidth 1kHz
 - Span 10MHz.
 - Searching at 200kHz to 1MHz from the carrier:
 - Resolution bandwidth 3kHz
 - Video bandwidth 1kHz

5.3.4.3 SSB Phase Noise

Test system	see Section Test Systems
Test method	The two signal generators are set to the test frequency and synchronized with a phase offset of 90° (phase quadrature). Mixing to 0 Hz suppresses the RF carrier, and due to the phase quadrature the mixer supplies a voltage corresponding to the phase difference between the input signals. This is measured by the LF spectrum analyzer and can be converted into SSB phase noise.
Measurement	<ul style="list-style-type: none"> ➤ Set the levels of the two signals generators according to the specifications of the mixer used (unmodulated or vector modulation with max. level). ➤ For calibration, reduce the level of the test item by 40dB and detune a signal generator by 20kHz. Check the signal for harmonics, the 2nd and 3rd harmonic should be more than 30dB below the fundamental. Measure the reference value at 20kHz at the analyzer and note it down. ➤ Cancel the detuning and produce the phase quadrature. To this end, set the level of the test item again and call it in the UTILITIES PHASE menu. Observe the output voltage of the mixer at the oscilloscope and vary the phase until the voltage becomes 0. ➤ Read the noise voltage at the analyzer, normalized to a bandwidth of 1 Hz (noise level).
Evaluation	<ul style="list-style-type: none"> ➤ Subtract from the reference value and add 6 dB for the second sideband measured (correlated) and 40 dB for the level switchover to the ratio found. If the signal-to-noise ratio of the second signal generator is not better than the one of the test item by at least 10 dB, the noise component of the reference transmitter must be determined and subtracted as well. <p>⇒ The corrected signal-to-noise ratio is the wanted measured value.</p> <p>Example: Let the reference level be measured to be 12dBm. A noise level of -78dBm(1Hz) is determined at 20 kHz. The difference is 90dB, in addition to the correction for the second sideband (6dB) and the level switchover (40dB) there is a signal-to-noise ratio of -136dB or a noise level of -136dBc (dB referred to the carrier power). If two identical signal generators have been used, the result must be decreased by 3 dB for the (uncorrelated) noise power of the reference transmitter.</p> <p>The final result is then -139dBc.</p>

5.3.4.4 Broadband Noise

Test system	see above under SSB phase noise.
Test method	<p>Calibration is carried out in the same way as above under SSB phase noise. For measurement, the signal generators are detuned until the difference frequency falls into the stop band of the lowpass filter so that it is sufficiently suppressed during the measurement. A Section of the sum of the broadband noise powers of both signal generators is to be measured at the spectrum analyzer then, mirrored at the zero line. The noise power at the distance of the difference frequency now lies at 0 Hz. The measurement is performed at the calibration frequency, which must be negligibly small compared with the difference frequency. Due to the mirror inversion of the spectrum at the zero line, the power measured must be halved.</p>
Measurement	<ul style="list-style-type: none"> ➤ Calibration as above under SSB phase noise. ➤ Increase the detuning to the measurement offset frequency (5 MHz). ➤ Set the level of the test item again and read the noise voltage at the analyzer at a center frequency of 20kHz, normalized to a bandwidth of 1 Hz (noise level).
Evaluation	<ul style="list-style-type: none"> ➤ Subtract from the reference level and add 43 dB for the level switchover and the mirror image. <p>The measured value is the sum of the noise powers of both signal generators. If the signal-to-noise ratio of the second signal generator is not better than the one of the test item by at least 10 dB, the noise component of the reference transmitter must be determined and subtracted as well.</p> <p>As the reference transmitter is located at the LO input, only the phase noise component is to be considered, which is 3 dB lower with broadband noise. In the case of two identical transmitters, the correction is another 3 dB. Note the higher level of the reference transmitter which, in general, further improves its signal-to-noise ratio.</p> <p>⇒ The corrected measured value is the wanted measurement result.</p>
Recommended test frequencies	see Table 5-2, at least * frequencies.

5.3.4.5 Residual FM

Note: The measurement of SSB phase noise usually makes a measurement of residual FM superfluous as it is more sensitive.

Test equipment	see Section Test Systems, Standard Test System for Analog Modulations.
Measurement	<ul style="list-style-type: none"> ➤ SMIQ settings <ul style="list-style-type: none"> - Frequency 1GHz, - Level 5.1dBm, unmodulated. ➤ Analyzer setting <ul style="list-style-type: none"> - Demodulation FM, rms value ➤ Determine the residual FM with ITU-T(CCITT) filtering 1Hz and with a test bandwidth of 30Hz to 23kHz.

5.3.4.6 Residual AM

Test equipment	as above.
Measurement	as above, but demodulation AM.

5.3.5 Level

5.3.5.1 Level Frequency Response and Linearity

Test equipment	<ul style="list-style-type: none"> - Power meter (Table 5-1, item 8) - Precision attenuator (Table 5-1, item 9) - Spectrum analyzer (Table 5-1, item 2) - Low-noise preamplifier (Table 5-1, item 10)
----------------	---

Test methods for levels in the measurement range of the power meter

Test setup	<ul style="list-style-type: none"> ➤ Connect power meter to RF output socket.
Measurement	<ul style="list-style-type: none"> ➤ SMIQ setting <ul style="list-style-type: none"> - RF level to be measured (see below), unmodulated. ➤ Measure the level at output frequencies from 300 kHz to 3300 MHz (Table 5-2). ➤ The frequency response is the difference between the highest and the lowest value measured. <ul style="list-style-type: none"> ⇒ The level error is the deviation from the set value.
Recommended test levels	13, 10, 5.1 dBm and in -5-dB steps up to the measurement limit of the power meter.

Test methods for low levels

- Test method** Level measurements below the measurement range of the power meter can be carried out by means of a comparison measurement using a precision attenuator and a sensitive test receiver or spectrum analyzer. The reference is a measurement using the power meter at the reference level, in this case 5.1 dBm.
- Test setup**
- Connect a precision attenuator to the RF output of the SMIQ and a spectrum analyzer with screened RF measurement cables to its output.
- Measurement**
- SMIQ settings
 - Test frequency
 - Reference level, unmodulated.
 - Test receiver or analyzer setting
 - Test frequency.
 - Attenuator setting
 - Attenuation 120 dB.
 - Read the level at the test receiver or analyzer and note down as reference value. It should be approx. -115 dBm. Select the test bandwidth small enough to ensure an exact reading.
 - Now repeat the measurement with the settings given in the table.
 - ⇒ The deviation of the indication at the analyzer from the reference value is the level error.

Level at SMIQ	Attenuation of the attenuator
Reference level	120 dB
Reference level -5 dB	115 dB
Reference level -10 dB	110 dB
Reference level -20 dB	100 dB
Reference level -40 dB	80 dB
Reference level -60 dB	60 dB
Reference level -80 dB	40 dB
Reference level -100 dB	20 dB
Reference level -120 dB	0 dB

Measurement of lowest levels

Caution: No RF leakage of the components used is the prerequisite for a correct measurement.

- Test setup**
- Connect a low-noise preamplifier between SMIQ and precision attenuator.
- Measurement**
- Perform a subsequent calibration with a level already measured.
 - ⇒ This allows levels to be measured down to the lower setting limit of the SMIQ.

5.3.5.2 Settling Time

- Test equipment see Section Test Systems.
- Test method The spectrum analyzer is operated as a fast level meter with a span of 0 Hz. A controller transfers start and stop level via the IEC bus. The storage oscilloscope is connected to the video output of the analyzer and triggered by the positive edge on the EOI line of the IEC bus. If the controller switches over from start to stop level, the settling procedure is displayed on the screen of the storage oscilloscope.
- Preparing the measurement
- Synchronize the reference frequencies of SMIQ and analyzer.
 - Establish IEC-bus and RF connections.
 - Connect storage oscilloscope to the video output of the analyzer.
 - Apply trigger connection to EOI line (pin 5) of IEC bus.
 - SMIQ settings
 - Test frequency 1GHz.
 - Storage oscilloscope settings
 - Time base 5 ms/div,
 - Sensitivity according to video output of analyzer.
 - Spectrum analyzer settings
 - Reference level 10 dBm,
 - Amplitude scale 10 dB/div,
 - Resolution bandwidth 300 kHz,
 - Video bandwidth 300 kHz,
 - Span 0 Hz.
- Measurement
- Storage oscilloscope setting
 - Triggering externally by the positive edge at 1.5 V.
 - Send the start level first and then the stop level from the controller.
 - ⇒ The level characteristic starting from the trigger point is displayed on the screen of the oscilloscope triggered externally.
 - Repeat the measurement with exchanged start and stop levels.
 - ⇒ The following steps are to be measured in both directions:

Setting	Start level	Stop level	Remark
CW, FM 10kHz	-34	6	with mech. attenuator
CW, FM 10kHz	6	10	without mech. attenuator
AM 30%	-40	0	with mech. attenuator
AM 30%	3	7	without mech. attenuator
VM max. level	-40	6	with mech. attenuator
VM max. level	3	7	without mech. attenuator
VM max. level, ALC OFF MODE TABLE	3	7	without mech. attenuator

Quick-Basic program for controller

```

CLS
iecadresse% = 28
CALL IBFIND("DEV1", generator%)
CALL IBPAD(generator%, iecadresse%)
iecterm% = &HA '
CALL IBEOS(generator%, iecterm% + &H800)
CALL IBWRT(generator%, "FREQ 1GHz")
DO
  INPUT "Start level in dBm";P1$
  INPUT "Stop level in dBm";P2$
  DO
    CALL IBWRT(generator%, "POW" + P1$ + "dBm")
    PRINT "level: ";P1$; "dBm"
    DO '
      kbd$ = INKEY$
      LOOP UNTIL LEN(kbd$)
      SWAP P1$, P2$
      LOOP UNTIL kbd$ = CHR$(27) '
      INPUT "repetition (y/n)"; w$
      LOOP UNTIL NOT UCASE$(w$) = "J"
    END
  
```

IEC-bus address of SMIQ (28)
 Open DEV1 and obtain access number
 Set IEC-bus address of DEV1 to 28
 Set EOS to LINE FEED

wait for key

Exit using ESCAPE

5.3.5.3 Output Impedance

Test equipment

see Section Test Systems

Test method

As the VSWR of a source must be measured, a purely passive measurement using the VSWR bridge is only possible with levels where the VSWR is determined by the output impedance of the mechanical attenuator only.

In the case of higher levels, the effect of the level control must be taken into account as well. For this purpose, an auxiliary transmitter is used which transmits a wave with a slightly offset carrier frequency (difference frequency within the control bandwidth of level control) into the test item, which is superimposed by the outgoing wave of the test item. In the case of an ideal source impedance, only the outgoing wave of the test item flows back into the bridge, in the case of a deviating source impedance, the two components are superimposed, which, due to the frequency offset, results in a beat, from the amplitude ratio of which the VSWR can be derived.

Measurement

- SMIQ settings
 - Test level
 - Test frequency, unmodulated.
- Spectrum analyzer settings
 - Test frequency, span 0 Hz, test level,
 - Resolution and video bandwidth 10 kHz,
 - Linear level scale
 - Sweep time 30 ms.
- Second signal generator settings
 - Detune the frequency by 100 Hz compared to the test frequency,
 - first minimum level, unmodulated.
- Vary the reference level to bring the indicated line approx. into the center of the screen at the spectrum analyzer and read and note down the level as reference level.
- Unscrew the VSWR bridge from the SMIQ and increase the level at the second signal generator until the reference level is measured again at the analyzer.
- Screw the bridge or directional coupler onto the SMIQ again.
 - ⇒ A more or less wavy line representing the VSWR of the SMIQ is to be seen now at the spectrum analyzer.
 - The VSWR is to be calculated from the maximum and minimum voltage

$$\text{VSWR} = V_{\max}/V_{\min}$$

Passive measurement of the VSWR with output levels of the SMIQ below -30 dBm.

- SMIQ settings
 - Test level
 - Frequency far from the test frequency, unmodulated.
- Second signal generator settings
 - Test frequency
 - Level 10 dBm.
- Unscrew the VSWR bridge from the test item and note down the level measured at the analyzer as reference value.
- Screw on the bridge or directional coupler again and determine the new level at the analyzer.
 - ⇒ The voltage ratio test level /reference level is the output reflection coefficient r of the test item.
 - The voltage standing wave ratio (VSWR) can be calculated according to the formula

$$\text{VSWR} = (1+r)/(1-r)$$

5.3.5.4 Non-interrupting Level Setting (ATTENUATOR MODE FIXED)

- Test equipment Power meter (Table 5-1, item 8)
- Test setup ➤ Connect the power meter to the RF output of the SMIQ.
- Measurement ➤ SMIQ settings
 - recommended test frequencies: 5, 100, 1000, 1500, 1501, 2200, 3000, 3001, 3300 MHz, unmodulated,
 - Level 5.1 dBm,
 - Select FIXED in the menu LEVEL/LEVEL ATTENUATOR MODE.
- Note down the level read at the power meter as reference level or set the power meter to 0 dB for relative measurement.
- Now reduce the level in steps of 5 dB at the SMIQ.
 ⇨ The following deviations should not be exceeded:

Attenuation in dB	Tolerance in dB
5	0.4
10	0.6
15	1.2
20	2.0

5.3.5.5 Overvoltage Protection

- Test equipment - Adjustable d.c. voltage source (Table 5-1, item 12)
 - Signal generator (Table 5-1, item 5)
 - Power amplifier (Table 5-1, item 13).
- Test setup ➤ Connect an adjustable d.c. voltage source to the RF output socket of the SMIQ via a 50-ohm resistor or a signal generator with a subsequent power amplifier with a power output of more than 1 Watt.
- Testing ➤ SMIQ settings
 - Frequency 100 MHz, unmodulated,
 - Level -120 dBm.
- Apply the d.c. voltage via the 50-ohm resistance.
 ⇨ The overvoltage protection must respond at a voltage of >4V and <7V with both polarities.
- Connect the signal generator to the RF output socket of the SMIQ and apply frequencies of up to 3300 MHz. Increase the level at each frequency, starting from 0.1W.
 ⇨ The overvoltage protection must respond at a supplied RF power of 1W.

5.3.6 Internal Modulation Generator

Test equipment	Audio analyzer (Table 5-1, item 14).
Test setup	<ul style="list-style-type: none"> ➤ Connect the audio analyzer to the LF socket of the SMIQ.
Measurement	<ul style="list-style-type: none"> ➤ SMIQ settings <ul style="list-style-type: none"> - Menu LF OUTPUT SOURCE LFGEN, VOLTAGE 1V, vary LFGEN FREQUENCY from 0.1 Hz to 1 MHz. ➤ Read the actual frequency at the audio analyzer. ➤ Read the distortion factor at the audio analyzer.
Recommended settings for distortion factor	20Hz, 300Hz, 1kHz, 3kHz, 10kHz, 30kHz, 100kHz
Measurement	<ul style="list-style-type: none"> ➤ SMIQ settings <ul style="list-style-type: none"> - Menu LF OUTPUT set LFGEN2 FREQUENCY 1 kHz. - vary VOLTAGE from 1 mV to 4 V. ➤ Measure the output level using the audio analyzer.
Recommended settings	3 mV, 10 mV, 30 mV, 100 mV, 300 mV, 1 V, 2 V, 4 V.
Frequency response	
Test equipment	AC voltmeter (Table 5-1, item 19).
Test setup	<ul style="list-style-type: none"> ➤ Connect AC voltmeter to the LF socket of the SMIQ.
Measurement	<ul style="list-style-type: none"> ➤ SMIQ settings <ul style="list-style-type: none"> - Menu LF OUTPUT SOURCE LFGEN, vary LFGEN FREQUENCY from 10 Hz to 1MHz. ➤ Measure the frequency response <ul style="list-style-type: none"> ⇒ The frequency response is the difference between highest and lowest level.

Note: The settling is a pure computer time and therefore does not need to be measured again.

5.3.7 Amplitude Modulation

5.3.7.1 Modulation Depth Setting

Test equipment see Section Test Systems, Standard Test System for Analog Modulations.

Measurement

- SMIQ settings
 - Level 0 dBm
 - select INT in the ANALOG MOD/AM/AM SOURCE menu, modulation depth 0.1% to 80% modulation frequency 1 kHz .
- Vary the carrier frequency from 5 MHz to 3300 MHz. For recommended setting values refer to Table 5-2, at least *-frequencies.
- Read the modulation depth at the modulation analyzer.

5.3.7.2 AM Frequency Response

Test equipment see Section Test Systems, Standard Test System for Analog Modulations with Audio Analyzer.

Measurement

- SMIQ settings
 - Level 0 dBm,
 - Set the menu ANALOG MOD/AM/AM SOURCE EXT EXT1,
 - modulation depth 60%.
- Vary the carrier frequency from 5 MHz to 3300 MHz. For recommended setting values refer to Table 5-2, at least *-frequencies.
- Audio analyzer setting
 - Generator level 1 V(V_{peak}).
- Vary the generator frequency to determine the modulation frequency response
 - ⇒ The modulation frequency response is the difference between the highest and the lowest modulation depth.
- Repeat the measurement using the internal modulation generator with the setting ANALOG MOD /AM/AM SOURCE INT.

5.3.7.3 AM Distortion Factor

Test equipment	see Section Test Systems, Standard Test System for Analog Modulations.
Measurement	<ul style="list-style-type: none">➤ SMIQ settings<ul style="list-style-type: none">- Level 2.1 dBm- Select INT in the ANALOG MOD/AM/AM SOURCE menu,- modulation depth 30 %- modulation frequency 1 kHz.➤ Vary the carrier frequency from 5 MHz to 3300 MHz. For recommended setting values see Table 5-2, at least *-frequencies.➤ Read the distortion factor at the modulation analyzer.➤ Repeat the measurement with 7.9 dBm and AM 80%.

5.3.7.4 Residual PhiM with AM

Test equipment	see Section Test Systems, Standard Test System for Analog Modulations.
Measurement	<ul style="list-style-type: none">➤ SMIQ settings<ul style="list-style-type: none">- Level 0 dBm- Select INT in the ANALOG MOD/AM/AM SOURCE menu- Modulation depth 30%- Modulation frequency 1 kHz.➤ Vary the carrier frequency from 5 MHz to 3300 MHz. For recommended setting values refer to table 5-2, at least *-frequencies.➤ Measure the phase modulation resulting by means of a 23-kHz lowpass filter and peak weighting at the modulation analyzer.

5.3.7.5 Level Monitoring at Input EXT1

Test equipment	see Section Test Systems, Standard Test System for Analog Modulations with Audio Analyzer
Test setup	<ul style="list-style-type: none">➤ Connect the generator output of the audio analyzer to the external modulation input EXT1.
Testing	<ul style="list-style-type: none">➤ SMIQ setting<ul style="list-style-type: none">- Select the menu ANALOG MOD/AM/AM SOURCE EXT EXT1.⇒ If the input level is correct, there must not be any error message.⇒ When the deviation reaches the value given in the data sheet, the respective message must appear in the display.

5.3.8 Broadband Amplitude Modulation

- Test equipment
- Spectrum Analyzer (Table 5-1, item 2)
 - Signal generator (Table 5-1, item 5)
- Test setup
- Connect the RF output of the SMIQ to the spectrum analyzer and the signal generator to the I(BB-AM) input of the SMIQ.
- Testing
- SMIQ setting
 - Test level 0dBm, test frequency > 30.3 MHz
 - select ON in the ANALOG MOD/BB-AM/STATE menu.
 - Signal generator setting
 - Level 0.25V (V_{peak}) corresponding to -2 dBm
 - Analyzer setting
 - Center frequency = test frequency, span 3 to 62MHz,
 - Reference level = test level +6dB
 - Scale 2dB/div.
 - Vary the frequency from 1 to 30 MHz at the signal generator and observe the modulation sidebands at the analyzer with appropriate span.
 - For evaluation, determine the offset of the modulation sidebands from the carrier. Result is the average of the sidebands
 - ⇒ As the sidebands feature a m/2 offset from the carrier, a 6dB offset corresponds to 100% AM.

5.3.9 Pulse Modulation (only with IQMOD Rev. >2)

5.3.9.1 ON/OFF Ratio

- Test equipment
- Spectrum analyzer (Table 5-1, item 2)
 - Pulse generator (Table 5-1, item 17)
- Test setup
- To determine the ON/OFF ratio connect a spectrum analyzer to the RF output socket of the SMIQ and a pulse generator to the PULSE socket on the rear panel of the SMIQ.
- Measurement
- SMIQ setting
 - Select EXT in the menu MODULATION/PULSE/SOURCE.
 - Determine the output level of the SMIQ at various carrier frequencies with "high" and "low" signal applied.
 - ⇒ The difference between the output level with a "high" signal applied and that with a "low" signal applied corresponds to the ON/OFF ratio.

5.3.9.2 Dynamic Characteristics

Test equipment	see Section Test Systems, Test System for Pulse Modulation.
Measurement	<ul style="list-style-type: none"> ➤ Simultaneously display the input signal from the pulse generator and the (down-converted) output signal on the dual-trace oscilloscope (triggering on the input signal). ➤ Pulse generator settings <ul style="list-style-type: none"> - Squarewave pulse sequence at a frequency of approx. 100 kHz, TTL level. ➤ SMIQ settings <ul style="list-style-type: none"> - Pulse modulation, level according to mixer used ➤ Vary the carrier frequency from 5 MHz to 3300 MHz. For recommended setting values refer to table 5-2, at least *-frequencies. ➤ With carrier frequencies > 50 MHz, use mixer and set an IF of approx. 50 MHz using the auxiliary transmitter ➤ Evaluate the pulse modulated RF output signal at the oscilloscope. <ul style="list-style-type: none"> ⇒ Rise time = time between 10% and 90% of the RF amplitude Fall time = time between 90% and 10% of the RF amplitude Pulse delay time = time between 50% of the input pulse amplitude and 50% of the RF amplitude.

5.3.10 Vector Modulation

5.3.10.1 Maximum Level

Test equipment	<ul style="list-style-type: none"> - Power meter (Table 5-1, item 8). - D.c. voltage source (Table 5-1, item 12).
Test setup	<ul style="list-style-type: none"> ➤ Connect power meter (Table 5-1, item 8) to the RF output socket. ➤ Connect d.c. voltage source to the I or Q input.
Measurement	<ul style="list-style-type: none"> ➤ SMIQ settings <ul style="list-style-type: none"> - Level 0 dBm. - Carrier frequency 900 MHz. ➤ Measure the level without modulation as reference level. ➤ Select ON in the menu VECTOR MOD/STATE. Set the d.c. voltage source to 0.500 V. Measure the level again. <ul style="list-style-type: none"> ⇒ The level difference must be <0.3 dB.

5.3.10.2 Input Impedance (VSWR)

Test equipment	Test system for output impedance.
Test setup	<ul style="list-style-type: none"> ➤ Connect the test port of the bridge to the I or Q input.
Measurement	<ul style="list-style-type: none"> ➤ SMIQ settings <ul style="list-style-type: none"> - Level 0 dBm. - Carrier frequency 900 MHz. - Select ON in the VECTOR MOD/STATE menu ➤ Signal analyzer settings <ul style="list-style-type: none"> - Level 10 dBm. - Carrier frequency 30 MHz. ➤ Unscrew the VSWR bridge at the test item and note down the level measured at the analyzer as reference value. ➤ Screw the bridge onto the I input and determine the new level at the analyzer. <ul style="list-style-type: none"> ⇒ The voltage ratio test level/reference level is the output reflection factor r of the test item. ➤ Calculate the voltage standing wave ratio (VSWR) according to the formula: $\text{VSWR} = (1+r)/(1-r)$ ➤ Repeat the measurement at the Q input.

5.3.10.3 Vector Error

Test equipment	see Section Test Systems, Vector Modulation
Measurement	<ul style="list-style-type: none"> ➤ SMIQ settings <ul style="list-style-type: none"> - Level 0 dBm - Select ON in the VECTOR MOD/STATE menu ➤ Generate a modulation signal at the ARB generator using the controller and the simulation program: Modulation 16QAM, no coding, $\sqrt{\cos}$ filter with $\alpha=0.5$, data PRBS-9-sequence, pulse width and oversampling 32, length 100 symbols, symbol clock 10kHz. ➤ Check if channels at the ARB generator are equal and set them if necessary. ➤ Carry out the respective settings at the demodulator. Synchronize with a bit sequence, starting with the 9th symbol, 12 bits long, result length 80 symbols. ➤ Vary the carrier frequency from 5 MHz to 3300 MHz. For recommended setting values see table 5-2, at least *-frequencies. ➤ Measure the error vector magnitude peak and rms at the demodulator.

5.3.10.4 Modulation Frequency Response

Test equipment	<ul style="list-style-type: none">- Spectrum analyzer (Table 5-1, item 2)- Signal generator (Table 5-1, item 5).
Test setup	<ul style="list-style-type: none">➤ Connect the RF output of the SMIQ to the spectrum analyzer and the signal generator to the I input of the SMIQ.
Test method	By applying a sinewave a.c. voltage at the I (or Q) input, an amplitude modulation with suppressed carrier is generated. The modulation frequency response is determined by measuring the sidebands depending on the frequency of the applied a.c. voltage.
Testing	<ul style="list-style-type: none">➤ SMIQ setting<ul style="list-style-type: none">- Test level 0dBm, test frequency > 30.3 MHz- select ON in the VECTOR MOD/STATE menu.➤ Signal generator setting<ul style="list-style-type: none">- Level 0.5V (Vpeak) corresponding to 4 dBm.➤ Analyzer setting<ul style="list-style-type: none">- Center frequency = test frequency, span 3 to 62MHz,- Reference level = test level +6dB- Scale 2dB/div.➤ Vary the frequency from 1 to 30 MHz at the signal generator and observe the modulation sidebands at the analyzer with appropriate span.<ul style="list-style-type: none">⇒ The result level for one sideband frequency is the average value of the left and right sideband level.➤ For evaluation, determine the difference between the modulation sidebands and the first sideband at 1 MHz.<ul style="list-style-type: none">⇒ The modulation frequency response is the difference between the highest and the lowest sideband.

5.3.10.5 Residual Carrier

Test equipment	Spectrum analyzer (Table 5-1, item 2).
Test setup	<ul style="list-style-type: none"> ➤ Connect the spectrum analyzer to the RF output of the SMIQ.
Measurement	<ul style="list-style-type: none"> ➤ SMIQ settings <ul style="list-style-type: none"> - Test frequencies according to table 5-2, unmodulated. - Level 0dBm. - Select OFF in the VECTOR MOD/STATE menu. ➤ Analyzer setting <ul style="list-style-type: none"> - Center frequency = test frequency, span 1MHz, - Reference level = test level - scale 10dB/div. ➤ First, measure the unmodulated level as reference. ➤ Then, switch on the vector modulation with open inputs (STATE ON) and measure the residual carrier. <ul style="list-style-type: none"> ⇒ The residual carrier in dBc corresponds to the level of the residual signal found referred to the output signal of the test item without modulation (dBc = referred to the carrier). ➤ SMIQ settings <ul style="list-style-type: none"> - IMPAIRMENT STATE ON - LEAKAGE 10%. <ul style="list-style-type: none"> ⇒ The residual carrier must increase to 10% (-20dBc)

5.3.10.6 IQ Imbalance

Measurement of imbalance

Test equipment	<ul style="list-style-type: none"> - Spectrum analyzer (Table 5-1, item 2) - Adjustable d.c. voltage source (Table 5-1, item 12).
Test setup	<ul style="list-style-type: none"> ➤ Connect the spectrum analyzer to the RF output of the SMIQ. ➤ Connect the d.c. voltage source to the I or Q input.
Measurement	<ul style="list-style-type: none"> ➤ SMIQ settings <ul style="list-style-type: none"> - Test frequency 900MHz - Level 0dBm. - Select ON in the VECTOR MOD/STATE menu. ➤ Analyzer setting <ul style="list-style-type: none"> - Center frequency = test frequency, span 1MHz - Reference level = test level +3dB - Scale 1dB/div. ➤ First, measure the undistorted level as reference. To this end, apply a d.c. voltage of 0.500 V to the I and the Q input and note down the associated RF level as reference. Then set VECTOR MOD/IMPAIRMENT/STATE ON and IMBALANCE 10% is in the menu. Finally, repeat the level measurements are repeated. <ul style="list-style-type: none"> ⇒ The I level must be increased by the set imbalance, the Q level must be reduced by the inverted ratio. With 10%, the I level must therefore be increased to 1.1, the Q level to 1/1.1 times the original value, i.e. it must be reduced to 0.909 times the original value (corresponds to ±0.83dB).

Measurement of quadrature error.

Test equipment	see Section Test Systems, Vector Modulation.
Measurement	<ul style="list-style-type: none"> ➤ SMIQ settings <ul style="list-style-type: none"> - Level 0 dBm - Test frequency 900MHz - Select the menu VECTOR MOD/STATE ON, IMPAIRMENT STATE OFF; QUADRATURE ERROR 10°. ➤ Generate a modulation signal using the controller and the simulation program: <ul style="list-style-type: none"> Modulation 16QAM, no coding, $\sqrt{\cos}$ filter with $\alpha=0.5$, data PRBS-9 sequence, pulse width and oversampling 32, length 100 symbols, symbol clock 10kHz. ➤ Carry out the respective settings at the demodulator. Synchronize with a bit sequence, starting with the 9th symbol, 12 bits long, result length 80 symbols. ➤ Select vector display at the demodulator. <ul style="list-style-type: none"> ⇒ The symbols must be located in a square grid. ➤ Now select IMPAIRMENT STATE ON at the SMIQ. <ul style="list-style-type: none"> ⇒ The symbols must not be arranged in a right angle any longer, the y-axis must be inclined towards the left by 10°, and towards the right with a setting of -10°.

5.3.10.7 Level Control POW RAMP

Test equipment	<ul style="list-style-type: none"> - Spectrum analyzer (Table 5-1, item 2) - 2 adjustable d.c. voltage sources (Table 5-1, item 12) - Function generator (Table 5-1, item 18 or 24) - Digital storage oscilloscope (Table 5-1, item 3).
Test setup	<ul style="list-style-type: none"> ➤ Connect the spectrum analyzer to the RF output of the SMIQ. ➤ Connect the 1st d.c. voltage source to the I-input with 0.50 V. ➤ Connect the 2nd d.c. voltage source to the POW RAMP input.

- Measurement
- SMIQ settings
 - Test frequency 900MHz
 - Level 0dBm.
 - Select ON in the VECTOR MOD/STATE menu.
 - Analyzer setting
 - Center frequency = test frequency, span 1MHz,
 - Reference level = test level
 - Scale 10dB/div.
 - First, measure the unattenuated level with 1.00 V at the POW RAMP input as a reference. Then reduce the voltage to 0.100V and measure the level again.
 - ⇒ A level that is 20 dB lower is expected. The attenuation error at -20dB is the deviation of this level from the expected value.
 - Then reduce the voltage to 0.00 V and determine the residual level is determined.
 - ⇒ The on/off ratio is the residual level referred to the reference level at 1 V.
- Test setup
- For measurement of the dynamic characteristics, connect a function generator to the POW RAMP input.
 - Connect one channel of the storage oscilloscope to the video output of the analyzer and the other one to the input signal from the function generator.
- Measurement
- Function generator setting
 - Squarewave signal with offset, lower level 0.1V, upper level 1.0V -
 - Frequency 100kHz.
 - Analyzer setting
 - Center frequency = test frequency, span 0Hz,
 - Reference level = test level
 - Scale 10dB/div
 - Resolution and video bandwidth 10MHz.
 - Trigger on the input signal at the oscilloscope and evaluate the RF output signal at the oscilloscope.
 - ⇒ Rise time = time between 10% and 90% of the RF amplitude
 - fall time = time between 90% and 10% of the RF amplitude
 - delay time = time between 50% of the input amplitude and 50% of the RF amplitude.

5.3.11 Frequency Modulation (Option FM Modulator)

5.3.11.1 FM Deviation Setting

Test equipment	see Section Test Systems, Standard Test System for Analog Modulations (use frequency divider for deviations > 500 kHz).
Measurement	<ul style="list-style-type: none"> ➤ SMIQ settings <ul style="list-style-type: none"> - RF 1GHz - Level 0 dBm or fitting the frequency divider - Select the menu ANALOG MOD/FM/FM1 SOURCE INT, - Modulation frequency 1 kHz - Deviation 300 Hz ... 500 kHz (see below). ➤ Read the FM deviation at the modulation analyzer. Multiply it with the divider factor, if applicable.
Recommended deviations	300 Hz ,1 , 3, 10, 30, 100, 250 and 500 kHz

5.3.11.2 FM Frequency Response

FM frequency response up to 100 kHz

Test equipment	see Section Test Systems, Standard Test System for Analog Modulations with Audio Analyzer
Measurement	<ul style="list-style-type: none"> ➤ SMIQ settings <ul style="list-style-type: none"> - Test frequency 100 MHz - Level 0 dBm - Select EXT1 in the ANALOG MOD/FM/FM1 SOURCE menu, - Deviation 50 kHz . ➤ Audio analyzer setting <ul style="list-style-type: none"> - Generator level 1 V(V_{peak}) . ➤ Determine the modulation frequency response by varying the generator frequency from 10 Hz to 100 kHz <ul style="list-style-type: none"> ⇒ The modulation frequency response is the difference between highest and lowest modulation depth. ➤ Repeat the measurement when frequency is fed at socket EXT2 and with setting ANALOG MOD/FM/FM2 SOURCE EXT2. ➤ Repeat the measurement with the internal modulation generator and the setting ANALOG MOD/FM/FM1 SOURCE INT.

Broadband FM frequency response

Test equipment see Section Test Systems, Broadband FM.

- Measurement
- SMIQ setting
 - Select EXT2 in the menu ANALOG MOD/FM/FM1/SOURCE and deviation according to the table.
 - Vary the frequency in 10kHz-steps at the SMIQ or sinewave generator until the voltmeter indicates 0V.
 - Switch the voltmeter to AC measurement and vary the frequency at the sine generator from 10 kHz to maximum frequency
 - Measure the modulation frequency response using the AC voltmeter.
 - ⇒ The modulation frequency response is the difference between highest and lowest modulation depth.
 - Repeat the measurement when the frequency is fed at socket EXT1 and with the setting MODULATION/FM/FM2 SOURCE EXT1.

Recommended settings:

F (RF)	50 MHz	750,1 MHz	1099 MHz	1101 MHz	1500 MHz	1501 MHz	3300 MHz
Deviation	500 kHz	250 kHz	250 kHz	250 kHz	250 kHz	500 kHz	500 kHz
Mixer	no	yes	yes	yes	yes	yes	yes
F (LO)	-	800,1 MHz	1149 MHz	1151 MHz	1550 MHz	1551 MHz	3350 MHz

5.3.11.3 FM Distortion Factor

Test equipment see Section Test Systems, Standard Test Systems for Analog Modulations (use frequency divider for deviations > 500 kHz).

- Measurement
- SMIQ settings
 - Carrier frequency 500 MHz 500MHz
 - Deviation 250kHz
 - Level 0 dBm
 - Select INT in the ANALOG MOD/FM/FM1 SOURCE menu,
 - Modulation frequency 1 kHz.
 - Read the distortion factor at the modulation analyzer.

5.3.11.4 FM Preemphasis.

Test equipment	see Section Test Systems, Standard Test System for Analog Modulations.
Measurement	<ul style="list-style-type: none">➤ Settings at the SMIQ<ul style="list-style-type: none">- Carrier frequency 100 MHz- Select INT in the ANALOG MOD/FM FM1 SOURCE menu,- Deviation 25 kHz.➤ Read the deviation at the modulation analyzer with a modulation frequency of 100 Hz and note down as reference value.➤ Switch on preemphasis 50 μs at the SMIQ and the modulation analyzer and increase the modulation frequency to 15 kHz.<ul style="list-style-type: none">⇒ The offset of the deviation now measured from the reference value is the wanted deviation error with preemphasis.➤ Repeat the measurement with preemphasis 75 μs.

5.3.11.5 Residual AM with FM

Test equipment	see Section Test Systems, Standard Test System for Analog Modulations.
Measurement	<ul style="list-style-type: none">➤ SMIQ settings<ul style="list-style-type: none">- Level 0 dBm,- Select INT in the MODULATION/FM/FM1 SOURCE menu,- Deviation 40 kHz ,- Modulation frequency 1 kHz.➤ Vary the carrier frequency from 5 MHz to 3300 MHz. For recommended setting values see Table 5-2, at least *-frequencies.➤ Measure the resulting amplitude modulation with a 23-kHz lowpass filter and peak weighting at the modulation analyzer.

Carrier Frequency Deviation with FM

Test equipment	see Section Test Systems, Standard Test System for Analog Modulations.
Measurement	<ul style="list-style-type: none">➤ SMIQ settings<ul style="list-style-type: none">- Frequency 400 MHz- Level 0 dBm- Select INT in the ANALOG MOD/FM/FM1 SOURCE menu,- Deviation 0 kHz .➤ Modulation analyzer setting<ul style="list-style-type: none">- Counter function➤ Measure the frequency offset when switching on the FM.➤ Increase the deviation to 200 kHz at the SMIQ.➤ Measure the frequency offset with FM with deviation..

5.3.11.7 Level Monitoring at Input EXT2

Test equipment	see Section Test Systems, Standard Test System for Analog Modulations with Audio Analyzer.
Test setup	<ul style="list-style-type: none">➤ Connect the generator output of the audio analyzer to external modulation input EXT2.
Testing	<ul style="list-style-type: none">➤ As with AM at input EXT1.

5.3.12 Phase Modulation (Option PM Modulator)

5.3.12.1 Deviation Setting

Test equipment	see Section Test Systems, Standard Test System for Analog Modulations.
Measurement	<ul style="list-style-type: none">➤ SMIQ settings<ul style="list-style-type: none">- Carrier frequency 1000 MHz- Level 0 dBm- Select INT in the ANALOG MOD/PM PM1 SOURCE menu,- deviation see below- Modulation frequency 1 kHz.➤ Read PhiM deviation at the modulation analyzer.
Recommended deviations	0.03, 0.1, 0.3, 1, 3, 10 rad.

5.3.12.2 PhiM Frequency Response

Test equipment	see Section Test Systems, Standard Test System for Analog Modulations with Audio Analyzer.
Measurement	<ul style="list-style-type: none">➤ SMIQ settings<ul style="list-style-type: none">- Carrier frequency 1000 MHz,- Level 0 dBm- Select EXT1 in the MODULATION/PM/PM1 SOURCE menu,- Deviation 5 rad.➤ Audio analyzer setting<ul style="list-style-type: none">- Generator level 1 V(V_{peak}).➤ Determine the modulation frequency response by varying the generator frequency of the analyzer.<ul style="list-style-type: none">⇒ The modulation frequency response is the difference between highest and lowest modulation depth➤ Repeat the measurement with the setting PM2 SOURCE EXT2.➤ Repeat the measurement with the setting PM1 SOURCE INT and variation of the frequency of the internal modulation generator.

5.3.12.3 PhiM Distortion Factor

Test equipment	see Section Test Systems, Standard Test System for Analog Modulations.
Measurement	<ul style="list-style-type: none">➤ SMIQ settings<ul style="list-style-type: none">- Carrier frequency 1 GHz- Level 0 dBm- Select INT in the ANALOG MOD/PM/PM1 SOURCE menu,- Deviation 5 rad- Modulation frequency 1 kHz➤ Read the distortion factor at the modulation analyzer.

5.3.13 Digital Modulation (Option SMIQB10)

5.3.13.1 Deviation Error for FSK

Test equipment	Demodulator for digital modulation (Table 5-1, item 23 or 27).
Measurement	<ul style="list-style-type: none">➤ SMIQ settings<ul style="list-style-type: none">- Level 0 dBm, RF 1 GHz- Switch on digital modulation FSK- Symbol rate 1 kHz, deviation 200 Hz- Filter GAUSS 0.2- Data source PRBS, length 23 bit➤ Make corresponding settings on demodulator, test bandwidth 10 kHz, evaluation over 150 symbols, 10 averaging➤ Measure FSK rms deviation error on demodulator.

5.3.13.1 Deviation Error for GFSK

Test equipment	Broadband demodulator for digital modulation (Table 5-1, item 27).
Measurement	<ul style="list-style-type: none">➤ SMIQ settings<ul style="list-style-type: none">- Level 0 dBm, RF 1 GHz- Switch on digital modulation GFSK- Symbol rate 1300 kHz, deviation 650 kHz- Filter GAUSS 0.7- Data source PRBS, length 23 bit➤ Make corresponding settings on demodulator, test bandwidth 5 MHz, evaluation over 150 symbols, 10 averaging➤ Measure GFSK rms deviation error on demodulator.

5.3.13.2 Phase Error for GMSK

Test equipment	Broadband demodulator for digital modulation (Table 5-1, item 27).
Measurement	<ul style="list-style-type: none">➤ SMIQ settings<ul style="list-style-type: none">- Level 0 dBm, RF 1 GHz- Switch off digital modulation GMSK- Symbol rate 1000- Filter GAUSS 0.3 and 1- Data source PRBS, length 23 bit➤ Make corresponding settings on demodulator, test bandwidth 7 MHz, evaluation over 150 symbols, 10 averaging➤ Measure GMSK rms phase error on demodulator.

5.3.13.3 Error Vector for DQPSK

Test equipment	Broadband demodulator for digital modulation (Table 5-1, item 27).
Measurement	<ul style="list-style-type: none">➤ SMIQ settings<ul style="list-style-type: none">- Level 0 dBm, RF 1 GHz- Switch on digital modulation $\pi/4$ DQPSK- Symbol rate 1/18/192/1500, and 3000 kHz- Filter SQR COS 0.25/0.35/0.5/0.7- Data source PRBS, length 23 bit➤ Make corresponding settings on demodulator, test bandwidth = double symbol rate, evaluation over 150 symbols, 10 averaging➤ Measure the rms error vector magnitude for all combinations of the given filters and symbol rates on demodulator.

5.3.13.5 Error Vector for QAM

Test equipment	Broadband demodulator for digital modulation (Table 5-1, item 27).
Measurement	<ul style="list-style-type: none">➤ SMIQ settings<ul style="list-style-type: none">- Level 0 dBm, RF 1 GHz- Switch on digital modulation 16QAM- Symbol rates 1 and 3 MHz- Filter SQR COS 0.35- Data source PRBS, length 23 Bit➤ Make corresponding settings on demodulator, test bandwidth = double symbol rate, evaluation over 150 symbols, 10 averaging➤ Measure the rms error vector magnitude for the given symbol rates on demodulator.

5.3.13.4 Error Vector for PHS

Test equipment	Demodulator for digital modulation (Table 5-1, items 23 or 27).
Measurement	<ul style="list-style-type: none">➤ SMIQ settings<ul style="list-style-type: none">- Level 0 dBm, RF 1900 MHz- Switch on digital modulation $\pi/4$ DQPSK- Symbol rate 192 kHz- Filter SQR COS 0.5- Data source PRBS, length 23 bit➤ Make corresponding settings on demodulator, test bandwidth = double symbol rate, evaluation over 150 symbols, 10 averaging➤ Measure rms error vector magnitude on demodulator.

5.3.13.5 Error Vector for NADC

Test equipment	Demodulator for digital modulation (Table 5-1, items 23 or 27).
Measurement	<ul style="list-style-type: none">➤ SMIQ settings<ul style="list-style-type: none">- Level 0 dBm, RF 824/894/1900 MHz- Switch on digital modulation $\pi/4$ DQPSK- Symbol rate 24.3 kHz- Filter SQR COS 0.35- Data source PRBS, length 23 bit➤ Make corresponding settings on demodulator, test bandwidth = double symbol rate, evaluation over 150 symbols, 10 averaging➤ Measure rms error vector magnitude for given RF frequencies on demodulator.

5.3.13.6 Error Vector for PDC

Test equipment	Demodulator for digital modulation (Table 5-1, items 23 or 27).
Measurement	<ul style="list-style-type: none">➤ SMIQ settings<ul style="list-style-type: none">- Level 0 dBm, RF 810/956/1500 MHz- Switch on digital modulation $\pi/4$ DQPSK- Symbol rate 21 kHz- Filter SQR COS 0.5- Data source PRBS, length 23 bit➤ Make corresponding settings on demodulator, test bandwidth = double symbol rate, evaluation over 150 symbols, 10 averaging➤ Measure rms error vector magnitude for given RF frequencies on demodulator.

5.3.13.7 Phase Error for GSM

Test equipment	Demodulator for digital modulation (Table 5-1, items 23 or 27).
Measurement	<ul style="list-style-type: none"> ➤ SMIQ settings <ul style="list-style-type: none"> - Level 0 dBm, RF 960 and 1800 MHz - Switch on digital modulation GMSK - Symbol rate 270.833 kHz - Filter GAUSS 0.3 - Data source PRBS, length 23 bit ➤ Make corresponding settings on demodulator, test bandwidth = double symbol rate, evaluation over 150 symbols, 10 averaging ➤ Measure GMSK rms phase error on demodulator.

5.3.14 Rho Factor for Digital Standard IS-95 CDMA (Option SMIQB42)

Test equipment	Broadband demodulator for digital modulation (Table 5-1, item 27).
Measurement	<ul style="list-style-type: none"> ➤ SMIQ settings <ul style="list-style-type: none"> 1st measurement <ul style="list-style-type: none"> - Level 0 dBm, RF 824/894/1900 MHz - Switch on digital IS-95 CDMA - Select mode Fwd Link 18 - Switch off all code channels except for pilot - For pilot channel set power to 0 dB 2nd measurement <ul style="list-style-type: none"> - Mode Rev Link, Full Rate, Data 000.. ➤ Select symbol rate 1.2288 MHz on demodulator. <ul style="list-style-type: none"> Measurement 1 with QPSK, forward link filter according to IS-95 (with equalizer), Measurement 2 with reverse link filter and OQPSK , Test bandwidth = double symbol rate, evaluation over 150 symbols, 10 averaging ➤ Measure rms error vector magnitude for given RF frequencies on demodulator. <ul style="list-style-type: none"> ⇒ The Rho factor is obtained from EVM to a good approximation according to the following equation: $\rho = 1 - \text{EVM}^2$

5.3.15 Data Generator (Option SMIQB11)

Test equipment	Storage oscilloscope (Table 5-1, item 3) at outputs for serial and parallel modulation data, clock and control signals.
Test method	The data generator is tested by programming data sequences consisting of modulation data, trigger signals and signals for level control. The programmed sequences are stored in the data generator memory and are read out cyclically. The correct reproduction of programmed lists can be checked at the corresponding output connectors.
Measurement	<ul style="list-style-type: none">➤ SMIQ settings<ul style="list-style-type: none">- Switch on digital modulation 256 QAM (8 bit/symbol)- Generate new data list with 8 identical bits per symbol- Select generated data list as data source- Generate and switch on new control list- Symbol rate 1 ksymbol/s- Trigger mode auto➤ Record data sequences with oscilloscope and check whether they correspond to the programmed sequences.➤ Repeat test for high symbol rates.<ul style="list-style-type: none">⇒ The maximum clock frequency of data and clock outputs is 7.5 MHz, at the outputs of control and trigger signals up to 1.5 MHz.

5.3.16 Fading Simulation

5.3.16.1 Frequency Response

Test equipment	<ul style="list-style-type: none">- Spectrum analyzer (Table 5-1, item 2)- Signal generator (Table 5-1, item 5).
Test setup	<ul style="list-style-type: none">➤ Connect RF output of SMIQ to spectrum analyzer and connect signal generator to I input of SMIQ.
Test method	<p>An amplitude modulation with suppressed carrier is generated by applying a sinusoidal AC voltage to the I input. The fading simulator is set so that a copy of the input signal which is only slightly shifted in the frequency is generated at its output. The amplitude modulation is maintained. The modulation frequency response is determined by measuring the sidebands depending on the frequency of the fed AC voltage.</p>
Measurement	<ul style="list-style-type: none">➤ SMIQ setting<ul style="list-style-type: none">- Test level -10 dBm, test frequency >15 MHz- Switch on vector modulation- Switch on fading simulation,- Path 1 with PURE DOPPLER, 0 dB, Doppler frequency 1 Hz- Other paths are switched off➤ Signal generator setting<ul style="list-style-type: none">- Level 0.5 V (V_{peak}) corresponding to 4 dBm.➤ Analyzer setting<ul style="list-style-type: none">- Center frequency = test frequency, span 20 MHz,- Reference level = test level- Scale 1 dB/div.➤ Vary the frequency from 0.1 to 10 MHz on the signal generator and observe the modulation sidebands on the analyzer.➤ For evaluation, determine the difference between the modulation sidebands and the first sideband at 0.1 MHz.<ul style="list-style-type: none">⇒ The modulation frequency response is the difference from the highest to the lowest sideband.

5.3.16.2 Level Error

Test system	Test system with spectrum analyzer for fading simulation
Test method	For vector modulation, a single-sideband amplitude modulation (SSB-AM) is generated by applying a sinusoidal signal to the I input and a cosine signal to the Q input. The effect of the fading simulator on the level accuracy is determined by means of two measurements performed with the fading simulator switched on and off.
Measurement	<ul style="list-style-type: none">➤ SMIQ setting<ul style="list-style-type: none">- Test level -10 dBm, test frequency >15 MHz- Switch on vector modulation- Switch on fading simulation,- Path 1 with PURE DOPPLER, 0 dB,- Doppler frequency 1 kHz, freq. ratio +1- Other paths are switched off➤ ARB generator setting<ul style="list-style-type: none">- Level 0.5V (Vpeak)- Channel 1 sinusoidal signal 10 kHz- Channel 2 cosine signal (90° phase to channel 1), 10 kHz➤ Spectrum analyzer setting<ul style="list-style-type: none">- Center frequency = test frequency, span 50 kHz,- Reference level = test level- Scale 5 dB/div.➤ Measure level of SSB-AM spectral line 11 kHz next to the carrier. Switch off fading simulation and measure level of SSB-AM spectral line 10 kHz next to carrier.➤ For evaluation determine the difference of measured levels.<ul style="list-style-type: none">⇒ The result is the level error caused by the fading simulator.

5.3.16.3 Path Attenuation

Test system	Test system with spectrum analyzer for fading simulation
Test method	<p>For vector modulation, a single-sideband amplitude modulation is generated by applying a sinusoidal signal to the I input and a cosine signal to the Q input. The second sideband and the carrier are suppressed.</p> <p>The fading simulator is set so that only a single transmission path with constant amplitude is available. The attenuation of this path for different settings of the path attenuation is checked by measuring the output level of SSB AM.</p>
Measurement	<ul style="list-style-type: none">➤ SMIQ setting<ul style="list-style-type: none">- Test level -10 dBm, test frequency >15 MHz- Switch on vector modulation- Switch on fading simulation,- Path 1 with PURE DOPPLER, 0 dB- Doppler frequency 1 kHz, freq. ratio +1- Other paths are switched off➤ ARB generator setting<ul style="list-style-type: none">- Level 0.5V (Vpeak)- Channel 1 sinusoidal signal 10 kHz- Channel 2 cosine signal (90° phase with reference to channel 1), 10 kHz➤ Spectrum analyzer setting<ul style="list-style-type: none">- Center frequency = test frequency + 11 kHz , span 0,- Resolution bandwidth 1 kHz, video bandwidth 100 Hz- Reference level = test level- Scale 2 dB/div.➤ Vary path attenuation between 0 and 20 dB in 2-dB steps on SMIQ and measure level on spectrum analyzer for each setting.<ul style="list-style-type: none">⇒ The measurement at 0 dB is the reference measurement. The difference between the measured attenuation (relative to the reference measurement) and the set path attenuation is evaluated.

5.3.16.4 Path Delay

Preliminary remark	Since various paths in the fading simulator are delayed fully digitally, a test is not necessarily required. Compliance with the setting accuracy is guaranteed by the digital hardware and software.
Test setup	Test setup with sampling oscilloscope for fading simulation, oscilloscope at I/Q output of fading simulator. A sampling oscilloscope with a sampling rate of at least 500 Msamples/s has to be used for checking data sheet compliance.
Test method	<p>With vector modulation and fading simulation switched on, a periodic pulse signal with short pulses is applied to the I input of SMIQ.</p> <p>The fading simulator is set so that two transmission paths with different delay are available. Two echoes of the pulse signal are thus received. The accuracy of the set path delay is tested by measuring the delay between the echoes at the output of the fading simulator.</p>
Measurement	<ul style="list-style-type: none">➤ SMIQ setting<ul style="list-style-type: none">- Test level -10 dBm- Switch on vector modulation- Switch on fading simulation,- Path 1 with PURE DOPPLER, 0 dB, 0 μs, freq. ratio 0- Path 2 with PURE DOPPLER, 0 dB, 1 μs, freq. ratio 0- Other paths are switched off➤ ARB generator setting<ul style="list-style-type: none">- Level 0.5V (Vpeak)- Channel 1 pulse signal with switch-on time 100 ns, switch-off time 2.6 μs➤ Sampling oscilloscope setting<ul style="list-style-type: none">- Time span 2 μs➤ Measure the time difference between the two pulse signals at output I or Q of fading simulator using the oscilloscope.<ul style="list-style-type: none">⇒ The measured time difference (rising edge) has to correspond accurately to the difference of the set path delays.

5.3.16.5 Doppler Shift

Test equipment	Frequency counter (Table 5-1, item 1).
Test setup	➤ Connect frequency counter to RF output of SMIQ.
Test method	<p>For vector modulation, a single-sideband amplitude modulation is generated by applying a sinusoidal signal to the I input and a cosine signal to the Q input. The second sideband and the carrier are suppressed (SSB AM).</p> <p>The fading simulator is set so that only a single transmission path with constant amplitude is available. With a Doppler shift set, the output frequency is shifted by the selected Doppler frequency. The accuracy of the setting is checked by measuring the output frequency for different settings of the Doppler frequency.</p>
Measurement	<ul style="list-style-type: none">➤ SMIQ setting<ul style="list-style-type: none">- Test level -10 dBm, test frequency >15 MHz- Switch on vector modulation- Switch on fading simulation,- Path 1 with PURE DOPPLER, 0 dB,- Doppler frequency 0.1/0.2/0.5/1 kHz- Other paths are switched off➤ ARB generator setting<ul style="list-style-type: none">- Level 0.5V (V_{peak})- Channel 1 sinusoidal signal 10 kHz- Channel 2 cosine signal (90° phase with reference to channel 1), 10 kHz➤ Measure output frequency by means of frequency counter.<ul style="list-style-type: none">⇒ The measured frequency differences have to correspond to the differences of the set Doppler frequency values.

5.4 Performance Test Protocol

ROHDE&SCHWARZ	SIGNAL GENERATOR SMIQ02/03	1084.8004.02/03.
Serial number:		
Person testing:		
Date:		
Signature:		

Item	Characteristic	Min.	Actual	Max.	Unit
5.3.1	Display and keyboard	checked			
5.3.2.1	Frequency setting	checked			
5.3.2.2	Settling time CW Vector modulation VM, ALC TABLE			15 30 15	ms ms ms
5.3.3	Reference frequency, deviation				Hz
5.3.4.1	Harmonics with level ≤ 10 dBm	-		-30	dBc
5.3.4.2	Spuriae, CW, >10kHz 0.3 to 450MHz >450 to 1500MHz >1500 to 3000MHz >3000MHz Vector mod., 10kHz to 300MHz 0.3 to 3000MHz ≥ 300 MHz			-74 -80 -74 -60 -70 -60	dBc dBc dBc dBc dBc dBc
5.3.4.4	Broadband noise with CW			-135	dBc
5.3.4.4	Broadband noise with vector modulation			-130	dBc
5.3.4.3	SSB phase noise CW, 20 kHz at RF 400MHz 1GHz 2GHz 3GHz with vector modulation at RF 400MHz 1GHz 2GHz 3GHz			-116 -126 -120 -116 -119 -123 -120 -116	dBc(1Hz) dBc(1Hz) dBc(1Hz) dBc(1Hz) dBc(1Hz) dBc(1Hz) dBc(1Hz) dBc(1Hz)
5.3.4.5	Residual FM rms at 1GHz 0.3 to 3kHz (ITU-T) 0.03 to 20kHz			1 4	Hz Hz
5.3.4.6	Residual AM, rms (0.03 to 20kHz)			0.02	%
5.3.5	Level, total error for level >-127dBm RF < 2GHz additional error with ALC OFF frequency response with 0dBm			± 1.5 ± 1.0 ± 0.3 1	dB dB dB dB
5.3.5.3	Output impedance (VSWR)			2	
5.3.5.2	Settling time (IEC bus) CW, analog modulation, with without mechanical attenuator vector modulation, with without mechanical attenuator ditto, with ALC MODE TABLE			25 10 40 25 10	ms ms ms ms ms

Item	Characteristic	Min.	Actual	Max.	Unit
5.3.5.4	Non-interrupting level setting	checked			
5.3.5.5	Overvoltage protection	checked			
5.3.6	Internal modulation generator frequency error distortion factor out put level 3mV 10mV 30mV 100mV 1V 2V 4V frequency response up to 100kHz up to 1MHz	2 9 28.7 98 .989 1.979 3.959		1*10 ⁻⁴ 0.1 4 11 31.3 102 1.011 2.021 4.041 0.4 2	% mV mV mV mV V V V dB dB
5.3.7	Amplitude modulation Modulation depth Distortion factor with AM 30% with AM 80% Frequency response, RF >5MHz RF <=5MHz Synchronous residual PhiM	56.6		63.4 1 2 1 3 0.1	% % % dB dB rad
5.3.7.5	Level monitoring EXT1 lower limit upper limit	0.97 1.01		0.99 1.03	V V
5.3.8	Broadband AM Modulation frequ. response 10MHz 30MHz			1 3	dB dB
5.3.9	Pulse modulation ON/OFF ratio Rise time Fall time Pulse delay time Video crosstalk			70 2 2 2 -30	dB µs µs µs dBc
5.3.10	Vector modulation Input impedance I Input impedance Q Max. level Vector error rms peak Modulation frequency response Residual carrier 0% Residual carrier 10% Imbalance (I≠Q) Quadrature error POW RAMP level error POW RAMP ON/OFF ratio Delay time Rise and fall time	-17 checked checked		1.2 1.2 0.3 0.5 1.0 3 -45 -23 . 80 2 1	dB dB % % dB dBc dBc dB dB µs µs
5.3.11.1	FM deviation setting at 300 Hz at 1 kHz at 3 kHz at 10 kHz at 30 kHz at 100 kHz at 250 kHz at 500 kHz	271 0.95 2.89 9.68 29.08 96.98 242.5 485		319 1.05 3.11 10.32 30.92 103.02 257.5 515	Hz kHz kHz kHz kHz kHz kHz kHz
5.3.11.2	FM frequency response EXT1 10 Hz to 100 kHz EXT2 10 Hz to 2 MHz EXT1 10 Hz...2 MHz EXT2 10 Hz to 2 MHz			0.5 0.5 3 3	dB dB dB dB

Item	Characteristic	Min.	Actual	Max.	Unit
5.3.11.3	FM distortion factor			0.5	%
5.3.11.4	FM-preemphasis 50 μ s 75 μ s			2 2	% %
5.3.11.5	Residual AM with FM			0.1	%
5.3.11.6	Frequency deviation with FM Deviation 0 Hz Deviation 200 kHz			50 2050	Hz Hz
5.3.11.7	Level monitoring EXT2 lower limit upper limit	0.97 1.01		0.99 1.03	V V
5.3.12.1	PhiM deviation setting at 30 mrad at 0.1 rad at 0.3 rad at 1.0 rad at 3.0 rad at 10 rad	19 0.087 0.281 0.96 2.90 9.69		41 0.113 0.319 1.040 3.10 10.31	mrad rad rad rad rad rad
5.3.12.2	PhiM frequency response EXT1 EXT2 INT			0.5 0.5 0.5	dB dB dB
5.3.12.3	PhiM distortion factor			1	%
5.3.13	Digital Modulation Deviation error for FSK Deviation error for GFSK Phase error for GMSK rms peak Error vector rms for PSK, 1 ksymbols/sPSK, 18 ksymbols/sPSK, 192 ksymbols/sPSK, 1500 ksymbols/sPSK, 3000 ksymbols/sQAM, 1000 ksymbols/sQAM, 3000 ksymbols/s			1.3 1.3 1 3 1.2 1.2 1.2 2 3 2 3	% % degree degree % % % % % % %
5.3.14	Digital Standard Error vector rms for PHS Error vector rms for NADC Error vector rms for PDC Phase error for GSM rms peak Error vector for IS-95 CDMA Rho factor for IS-95 CDMA		0.9995	1.2 1.2 1.2 1 3 2.2	% % % ° ° %
5.3.15	Functional check of data generator	checked			
5.3.16	Fading Simulation Frequency response up to 5 MHz offset -3 dB limit frequency Level error Error of path attenuation Error of path delay Error of Doppler shift	7		0.6 0.5 0.3 5 0.13	" " " " dB MHz dB dB ns %"

.....



Annex A

IEC/IEEE Bus Interface

The instrument is equipped with an IEC/IEEE-bus connection as a standard. The mating connector according to IEEE 488 is at the rear of the instrument. A controller for remote control can be connected via the interface. The connection is effected using a shielded cable.

Characteristics of the Interface

- 8-bit parallel data transfer
- bidirectional data transfer
- three line handshake
- high data transfer rate of max. 350 kByte/s
- up to 15 devices can be connected
- maximal length of the connecting cables 15 m (single connection 2m)
- wired OR if several instruments are connected in parallel.

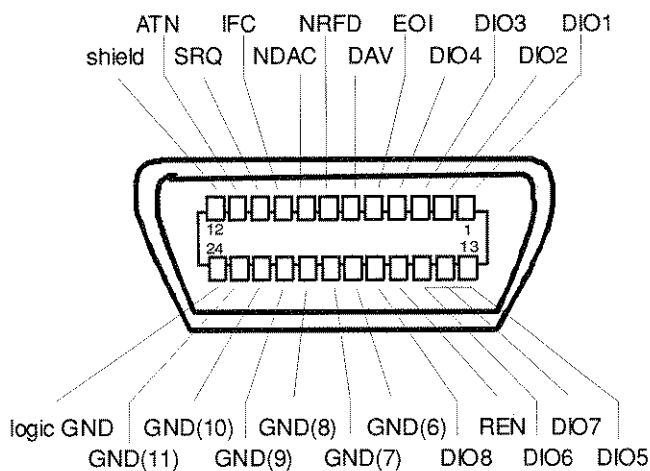

Fig. A-1 Contact Assignment of the IEC-bus socket

Bus Lines

1. Data bus with 8 lines DIO 1 to DIO 8.

The transmission is bit-parallel and byte-serial in the ASCII/ISO code. DIO1 is the bit of lowest order, DIO8 the bit of highest order.

2. Control bus with 5 lines.

IFC (Interface Clear),
active low resets the interfaces of the instruments connected to the default setting.

ATN (Attention),
active low signals the transmission of interface messages
inactive high signals the transmission of device-dependent messages.

SRQ (Service Request),
active low enables a device connected to send a service request to the controller.

REN (Remote Enable),
active low permits the switchover to remote control.

EOI (End or Identify),
has two functions in connection with ATN:
active low marks the end of data transmission with ATN=high
active low triggers a parallel poll with ATN=low.

3. Handshake bus with three lines.

DAV (Data Valid),
active low signals a valid data byte on the data bus.

NRFD (Not Ready For Data),
active low signals that one of the device connected is not ready for data transfer.

NDAC (Not Data Accepted),
active low as long as the instrument connected is accepting the data present on the data bus.

Interface Functions

Instruments which can be remote-controlled via IEC bus can be equipped with different interface functions. Table A-1 lists the interface functions appropriate for the instrument.

Table A-1 Interface function

Control character	Interface function
SH1	Handshake source function (source handshake)
AH1	Handshake drain function (acceptor handshake)
L4	Listener function.
T6	Talker function, ability to respond to serial poll
SR1	Service request function (Service Request)
PP1	Parallel poll function
RL1	Remote/Local switchover function
DC1	Resetting function (Device Clear)
DT1	Trigger function (Device Trigger)

Interface Messages

Interface messages are transmitted to the instrument on the data lines, with the attention line being active (LOW). They serve to communicate between instrument and controller.

Universal Commands

The universal commands are encoded in the range 10 through 1F hex. They are effective for all instruments connected to the bus without addressing them before.

Table A-2 Universal Commands

Command	QuickBASIC command	Effect on the instrument
DCL (Device Clear)	IBCMD (controller%, CHR\$(20))	Aborts the processing of the commands just received and sets the command processing software to a defined initial state. Does not change the instrument setting.
IFC (Interface Clear)	IBSIC (controller%)	Resets the interfaces to the default setting.
LLO (Local Lockout)	IBCMD (controller%, CHR\$(17))	The LOC/IEC ADDR key is disabled.
SPE (Serial Poll Enable)	IBCMD (controller%, CHR\$(24))	Ready for serial poll
SPD (Serial Poll Disable)	IBCMD (controller%, CHR\$(25))	End of serial poll
PPU (Parallel Poll Unconfigure)	IBCMD (controller%, CHR\$(21))	End of the parallel-poll polling state

Addressed Commands

The addressed commands are encoded in the range 00 through 0F hex. They are only effective for instruments addressed as listeners.

Table A-3 Addressed Commands

Command	QuickBASIC command	Effect on the instrument
SDC (Selected Device Clear)	IBCLR (device%)	Aborts the processing of the commands just received and sets the command processing software to a defined initial state. Does not change the instrument setting.
GET (Group Execute Trigger)	IBTRG (device%)	Triggers a previously active device function (eg a sweep). The effect of the command is the same as with that of a pulse at the external trigger signal input.
GTL (Go to Local)	IBLOC (device%)	Transition to the "Local" state (manual control)
PPC (Parallel Poll Configure)	IBPPC (device%, data%)	Configure instrument for parallel poll. The QuickBASIC command additionally executes PPE / PPD.

RS-232-C Interface

The instrument is fitted with an RS-232-C interface as standard. The 9-pin connector is at the rear panel. A controller can be connected via this interface for remote control.

Interface characteristics

- Serial data transmission in asynchronous mode
- Bidirectional data transmission via two separate lines
- Transmission rate selectable from 1200 to 115200 baud
- Logic 0 signal from +3 V to +15 V
- Logic 1 signal from -15 V to -3 V
- An external instrument (controller) can be connected
- Software handshake (XON, XOFF)
- v Hardware handshake

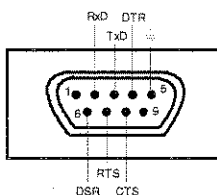

Fig. A-2 Pin assignment of RS-232-C connector

Signal lines

RxD (Receive Data),

Data line, transmission from external controller to instrument.

TxD (Transmit Data),

Data line, transmission from instrument to external controller.

DTR (Data terminal ready),

Output (log. 0 = active). With DTR, the instrument indicates that it is ready to receive data. The DTR line controls whether the instrument is ready for reception or not.

GND,

Interface ground, connected to instrument ground.

DSR (Data set ready),

(Instead of the CTS line, the DSR connector is used for instruments with a VAR2 REV3 front module.)

RTS (Request to send),

Output (log 0 = active). With RTS, the instrument indicates that it is ready to receive data. The RTS line controls whether the instrument is ready for reception or not.

CTS (Clear to send),

Input (log 0 = active). CTS tells the instrument that the opposite station is ready to receive data.

Transmission parameters

To ensure an error-free and correct data transmission, the parameters of the instrument and the controller should have the same settings. The parameters are set in menu UTILITIES-SYSTEM-RS232.

Transmission rate (baud rate) The following baud rates can be set in the instrument: 1200, 2400, 4800, 9600, 19200, 38400, 57600, 115200.

Data bits Data transmission is in 8-bit ASCII code. The first bit transmitted is the LSB (Least Significant Bit).

Start bit Each data byte begins with a start bit. The falling edge of the start bit indicates the beginning of the data byte.

Parity bit A parity bit is not used.

Stop bit The transmission of a data byte is terminated by a stop bit.

Example:

Transmission of character A (41 hex) in the 8-bit ASCII code.

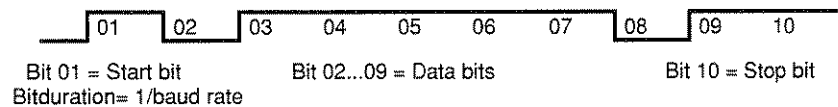

Interface functions

For interface control, some control characters defined from 0 to 20 hex of the ASCII code can be transmitted via the interface (see Table A-4).

Table A-4 Interface functions (RS-232-C)

Control character	Interface function
<Ctrl Q> 11 hex	Enables character output (XON)
<Ctrl S> 13 hex	Inhibits character output (XOFF)
Break (at least 1 character only log 0)	Reset instrument
0Dhex, 0Ahex	Terminator <CR>, <LF> Switchover between local/remote

Handshake

Software handshake

The software handshake with the XON/XOFF protocol controls data transmission. If the receiver wishes to inhibit data entry, it sends XOFF to the transmitter. The transmitter then interrupts the data output until it receives a XON. The same function is provided at the transmitter side (controller).

Note: Software handshake is not suitable for transmission of binary data. Use the hardware handshake.

Hardware handshake

In case of a hardware handshake the instrument signals that it is ready for reception via line DTR and RTS. A logic 0 means "ready" and a 1 means "not ready". Whether the controller is ready for reception or not is signalled to the instrument via lines CTS or DSR (see signal lines). The transmitter of the instrument is switched on by a 0 and off by a 1. Line RTS remains active as long as the serial interface is active. Line DTR controls whether the instrument is ready for reception or not.

Connection between instrument and controller

Connection of the instrument with the controller is via a so-called 0-modem cable. In this case, the data, control and signalling lines have to be cross-connected. For a controller with a 9-pin or 25-pin connector the following circuit diagram applies.

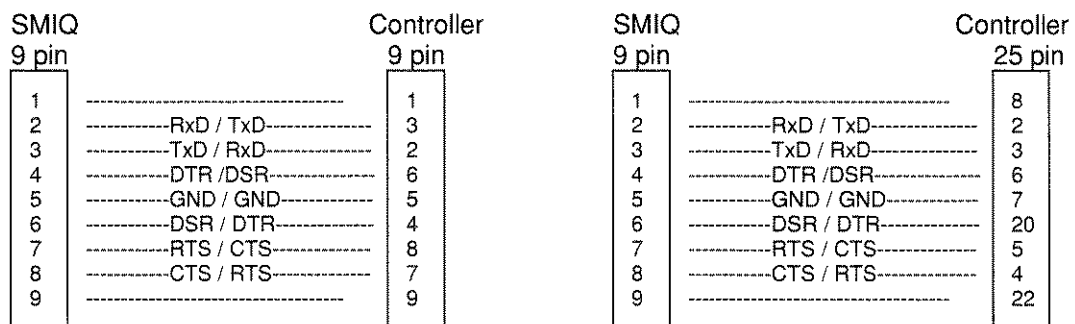

Fig. A-3 Wiring of data, control and signalling lines for hardware handshake

Asynchronous Interface SERDATA

The SERDATA interface on the rear of SMIQ serves for the asynchronous serial transmission of modulation data. It is a RS-232-C interface with the following characteristics:

- Data transmission to SMIQ in one direction only via RxD line (Receive Data).
- Selectable data rate in menu UTILITIES-SYSTEM-SERDATA-BAUDRATE. The highest baud rate is 115 200.
- Hardware handshake only via RTS line (Request to send). With RTS, SMIQ is ready to receive data. After inactivating RTS, SMIQ can receive 32 bytes at max.
- Data transmission with start bit, 8 data bits (= 1 byte), stop bit. A parity bit is not used. The most significant bit of each modulation symbol has to be transmitted at first.

Note: *The baud rate has to be selected at least 25% higher than the bit rate of the digital modulation. If SMIQ has not enough data, the error message "Data underrun" will be issued in the status line.*

Connection between SERDATA and the external RS-232 data source is via a so-called null modem cable with crossed data and control lines.

.....



Annex B

List of Error Messages

The following list contains all error messages for errors occurring in the instrument. The meaning of negative error codes is defined in SCPI, positive error codes mark errors specific of the instrument.

The table contains the error code in the left-hand column. In the right-hand column the error text being entered into the error/event queue or being displayed is printed in bold face. Below the error text, there is an explanation as to the respective error.

SCPI-Specific Error Messages

No Error

Error code	Error text in the case of queue poll Error explanation
0	No error This message is output if the error queue does not contain entries.

Command Error - Faulty command; sets bit 5 in the ESR register

Error code	Error text in the case of queue poll Error explanation
-100	Command Error The command is faulty or invalid.
-101	Invalid Character The command contains an invalid sign. Example: A header contains an ampersand, "SOURCE&".
-102	Syntax error The command is invalid. Example: The command contains block data the instrument does not accept.
-103	Invalid separator The command contains an impermissible sign instead of a separator. Example: A semicolon is missing after the command.
-104	Data type error The command contains an invalid value indication. Example: ON is indicated instead of a numeric value for frequency setting.
-105	GET not allowed A Group Execute Trigger (GET) is within a command line.
-108	Parameter not allowed The command contains too many parameters. Example: Command SOURCE:FM:INTERNAL:FREQUENCY permits only one frequency indication.

Continuation: Command Error

Error code	Error text in the case of queue poll Error explanation
-109	Missing parameter The command contains too few parameters. Example: Command <code>SOURce:FM:INTernal:FREQuency</code> requires a frequency indication.
-112	Program mnemonic too long The header contains more than 12 signs.
-113	Undefined header The header is not defined for the instrument. Example: <code>*XYZ</code> is undefined for every instrument.
-114	Header suffix out of range The header contains an impermissible numeric suffix. Example: <code>SOURce3</code> does not exist in the instrument.
-123	Exponent too large The absolute value of the exponent is larger than 32000.
-124	Too many digits The number contains too many digits.
-128	Numeric data not allowed The command contains a number which is not allowed at this position. Example: Command <code>SOURce:FREQuency:MODE</code> requires the indication of a text parameter.
-131	Invalid suffix The suffix is invalid for this instrument. Example: <code>nHz</code> is not defined.
-134	Suffix too long The suffix contains more than 12 signs.
-138	Suffix not allowed A suffix is not allowed for this command or at this position of the command. Example: Command <code>*RCL</code> does not permit indicating a suffix.
-141	Invalid character data The text parameter either contains an invalid sign or it is invalid for this command Example: <code>write error with parameter indication; SOURce:FREQuency:MODE FIXed.</code>
-144	Character data too long The text parameter contains more than 12 signs.
-148	Character data not allowed The text parameter is not allowed for this command or at this position of the command. Example: Command <code>*RCL</code> requires a number to be indicated.
-158	String data not allowed The command contains a valid character string at a position which is not allowed. Example: A text parameter is set in quotation marks, <code>SOURce:FREQuency:MODE "FIXed"</code>
-161	Invalid block data The command contains faulty block data. Example: An END message was received before the expected number of data had been received.

Execution Error - Error in executing the command; sets bit 4 in the ESR register

Error code	Error text in the case of queue poll Error explanation
-168	Block data not allowed The command contains valid block data at an impermissible position.
-178	Expression data not allowed The command contains a mathematical expression at an impermissible position.
-203	Command protected The desired command could not be executed as it was protected with a password. Use command <code>SYSTem:PROTect OFF, <password></code> to enable the command. Example: The command <code>CALibrate:PULSe:MEASure?</code> is protected with a password.
-211	Trigger ignored The trigger (GET, *TRG or trigger signal) was ignored due to device timing considerations.
-221	Settings conflict There is a settings conflict between two parameters. Example: FM1 and PM1 cannot be switched on at the same time.
-221	Filter type vs. filter parameter The value set for the filter parameter is too large or too small for the filter type selected. The filter parameter is internally set to 0.5.
-221	Symbol rate vs. FSK deviation The value set for the FSK deviation is either too large or too small for the symbol rate selected. The maximum possible value for the deviation is set.
-221	Modulation type vs. coding The modulation type and coding selected are not compatible. The coding is deactivated internally.
-221	Modulation type vs. filter type The modulation and filter types selected are not compatible. An allowed filter type is activated internally.
-221	Modulation type vs. symbol rate The modulation type selected (MSK or FSK) can be generated for symbol rates up to a maximum of 2.5 MSymb/s. The symbol rate is internally limited to 2.5 MSymb/s.
-221	Control list state vs. symbol rate The setting CONTROL STATE ON is permissible for symbol rates up to a maximum of 2.5 MSymb/s. The symbol rate is internally limited to 2.5 MSymb/s.
-222	Data out of range The parameter value is out of the range permitted by the instrument. Example: Command *RCL only permits entries in the range of 0 to 50
-223	Too much data The command contains too many data. Example: The instrument does not have sufficient storage space.
-224	Illegal parameter value The parameter value is invalid. Example: An invalid text parameter is indicated, <code>TRIGger:SWEp:SOURce TASTe</code>
-225	Out of memory The storage space available in the instrument is exhausted. Example: An attempt is made to create more than 10 Memory Sequence lists.

Continuation: Execution Error

Error code	Error text in the case of queue poll Error explanation
-226	<p>Lists not of same length</p> <p>The parts of a list have different lengths. This error message is also displayed if only part of a list has been transmitted via IEC bus. All parts of the list have to be transmitted always before it is executed. Example: The POWer list content is longer than the FREQuency list content, or only the POWer content is transmitted.</p>
-230	<p>Data corrupt or stale</p> <p>The data are incomplete or invalid. Example: The instrument has aborted a measurement.</p>
-240	<p>Hardware error</p> <p>The command cannot be executed due to problems with the instrument hardware.</p>
-241	<p>Hardware missing</p> <p>The command cannot be executed due to missing hardware. Example: An option is not fitted.</p>
-255	<p>Directory full</p> <p>The list management cannot accept any more lists as the maximum number of lists has already be attained. Example: Only 10 MEM SEQ lists can be created.</p>

Device Specific Error - sets bit 3 in the ESR register.

Error code	Error text in the case of queue poll Error explanation
-310	System error This error message suggests an error within the instrument. Please inform the R&S Service.
-311	Memory error Error in the instrument memory.
-313	Calibration memory lost Loss of calibration data stored. The calibration data of VCO SUM, LEVEL PRESET and PULSE GEN can be restored by internal routines (see Chapter 2, Section Calibration).
-314	Save/recall memory lost Loss of the non-volatile data stored using *SAV? command.
-315	Configuration memory lost Loss of the non-volatile configuration data stored by the instrument.
-330	Self-test failed The selftest could not be executed.
-350	Queue overflow This error code is entered into the queue instead of the actual error code if the queue is full. It indicates that an error has occurred but not been accepted. The queue can accept 5 entries.
-360	Communication error An error has occurred during the transmission or reception of data on the IEC/IEEE bus or via the RS-232 interface.

Query Error - Error in data request; sets bit 2 in the ESR register.

Error code	Error text in the case of queue poll Error explanation
-410	Query INTERRUPTED The query has been interrupted. Example: After a query, the instrument receives new data before the response has been sent completely.
-420	Query UNTERMINATED The query is incomplete. Example: The instrument is addressed as a talker and receives incomplete data.
-430	Query DEADLOCKED The query cannot be processed. Example: The input and output buffers are full, the instrument cannot continue operation.

SMIQ-Specific Error Messages

Device-dependent Error - device-specific error; sets bit 3 in the ESR register.

Error code	Error text in the case of queue poll Error explanation
105	Frequency underrange The frequency is below the limit value guaranteed.
106	Frequency overrange The frequency is beyond the limit value guaranteed.
110	Output unlevelled; All failure The level control loop is without function.
111	IQCON: ALC loop failure The local level control loop of the IQCON module is without function.
115	Level overrange The level is above the limit value guaranteed.
116	Level underrange The level is below the limit value guaranteed.
117	Dynamic level range exceeded The difference between the maximal and minimal value of a level list is above 20 dBm. An exact level setting is no longer guaranteed.
130	FM modulator VCO unlocked FM modulator VCO is not synchronized.
131	AM modulation frequency out of range The AM modulation frequency is out of the permissible range.
132	PM modulation frequency out of range The PM modulation frequency is out of the permissible range.
140	This modulation forces other modulations OFF A modulation has been switched on which cannot be used at the same time as an already active modulation. The previous modulation has been switched off.
152	Input voltage out of range; EXT1 too high The input voltage at the EXT1 socket is too high.
153	Input voltage out of range; EXT1 too low The input voltage at the EXT1 socket is too low.
154	Input voltage out of range; EXT2 too high The input voltage at the EXT2 socket is too high.
155	Input voltage out of range; EXT2 too low The input voltage at the EXT2 socket is too low.
161	Output protection tripped The overvoltage protection has responded (cf. Section 2.5.8).
171	Oven cold The reference oscillator has not yet reached its operating temperature.
172	Reference frequency 100 MHz VCXO unlocked The 100-MHz quartz oscillator of the reference frequency has not been synchronized.
173	Step synthesis unlocked The step synthesis has not been synchronized.

Error code	Error text in the case of queue poll Error explanation
180	Calibration failed Calibration could not be executed.
181	REF OSC calibration data not used because ADJUSTMENT STATE is ON The reference-oscillator calibration data are not used as long as ADJUSTMENT STATE is activated.
182	Calibration data missing Calibration data are missing in the device memory. The calibration data have to be generated first by an internal or external calibration or to be loaded into the device.
200	Cannot access hardware The data transmission to a module was unsuccessful.
201	Function not supported by this hardware revision A later version of certain parts of the instrument is necessary to execute the function selected.
202	Diagnostic A/D converter failure Diagnostic A/D converter has failed.
211	Summing loop unlocked The PLL of the summing loop has not been synchronized.
221	Digital synthesis buffer VCO unlocked The VCO of the buffer loop has not been synchronized.
224	2.4 GHz LO loop unlocked The 2.4 GHz local oscillator of the IQMOD module has not been synchronized.
231	DATA coder clock unlocked The clock oscillator of the data coder has not been synchronized.
232	Cannot access data coder RAM No data can be sent to the data coder. The data coder cannot be used as a source for a digital modulation.
240	Invalid list; odd number of elements The list selected contains an odd number of elements. Some lists, however, must contain an even number of elements.
241	No list defined There is no list defined..
242	List not learned; execute LEARN command The instrument has been switched to LIST mode and a list has been selected. However, command LEARN has not been executed.
243	Dwell time adjusted A dwell time given on a list cannot be processed by the unit. The setting was automatically adjusted.
251	No User Correction Table; zero assumed An attempt has been made to switch on user correction, but no UCOR table has been stored in the instrument yet. The instrument behaves as if a table was called which only contains 0-values.
260	Invalid keyboard input ignored An invalid input via the keyboard is not considered.
265	This parameter is read only An attempt has been made to change a fixedly specified value.
270	Data output aborted Data output was aborted on the IEC/IEEE-bus. Example: The key [LOCAL] was pressed.

Continuation: Device-dependent Error

Error code	Error text in the case of queue poll Error explanation
304	String too long A character string which is too long was received via the IEC bus. The names of lists may have a length of maximally seven letters.
305	Fill pattern too long; truncated More data have been entered with block function FILL in the list editor than the filling range (RANGE) set permits. The exceeding data are ignored.
306	No fill pattern specified An attempt was made to execute a filler function without having to indicate a filler pattern.

Annex C

List of Commands (with SCPI Conformity Information)

The supports SCPI version 1994.0. For remote control, commands which were specified or accepted in this SCPI version have been used to a large extent. Commands which are not part of the SCPI specification are marked "not-SCPI" in the SCPI info.

Command	Parameter	SCPI-Info	Page
:ABORt:LIST		not-SCPI	3.17
:ABORt:MSEquence		not-SCPI	3.17
:ABORt[:SWEep]		not-SCPI	3.17
:CALibration[:ALL]			3.18
:CALibration:FSIM[:MEASure]?		not-SCPI	3.18
:CALibration:LATTenuation[:MEASure]?		not-SCPI	3.18
:CALibration:LEVel:DATA?		not-SCPI	3.19
:CALibration:LEVel:STATe	ON OFF	not-SCPI	3.19
:CALibration:LPReset:DATA?		not-SCPI	3.19
:CALibration:LPReset[:MEASure]?		not-SCPI	3.19
:CALibration:ROSCillator[:DATA]	0 to 4095	not-SCPI	3.19
:CALibration:VMODulation[:MEASure]?		not-SCPI	3.20
:CALibration:VSUMmation:DAC?		not-SCPI	3.20
:CALibration:VSUMmation:KOS?		not-SCPI	3.20
:CALibration:VSUMmation:OFFS?		not-SCPI	3.20
:CALibration:VSUMmation[:MEASure]?		not-SCPI	3.19
:DIAGnostic:INFO:CCOunt:ATTenuator1 2 3 4 5 6?			3.21
:DIAGnostic:INFO:CCOunt:MODules?			3.22
:DIAGnostic:INFO:CCOunt:OTIMe?			3.22
:DIAGnostic:INFO:CCOunt:POWer?			3.21
:DIAGnostic:INFO:CCOunt:SDATe?			3.22
:DIAGnostic[:MEASure]:POINt?			3.22
:DISPlay:ANNotation[:ALL]	ON OFF		3.23
:DISPlay:ANNotation:AMPLitude	ON OFF		3.23
:DISPlay:ANNotation:FREQuency	ON OFF		3.23
:FORMat:BORDer	NORMal SWAPped		3.24
:FORMat:DATA	ASCIi REAL[, 32 64] PACKed		3.24
:MEMory:NSTates?			3.25
:OUTPut:AFIXed RANGe LOWer?		not-SCPI	3.26
:OUTPut:AFIXed RANGe UPPer?		not-SCPI	3.26
:OUTPut:AMODe	AUTO FIXed	not-SCPI	3.25
:OUTPut:BLANK:POLarity	NORMal INVerted	not-SCPI	3.26
:OUTPut:IMPedance?			3.26

Command	Parameter	SCPI-Info	Page
:OUTPut:PROTEction:CLEar			3.26
:OUTPut:PROTEction:TRIPped?			3.26
:OUTPut[:STATe]	ON OFF		3.27
:OUTPut[:STATe]:PON	OFF UNCHanged	not-SCPI	3.27
:OUTPut2[:STATe]	ON OFF		3.28
:OUTPut2:VOLTag	0V to 4V	not-SCPI	3.28
[:SOURce]:AM:BBANd[:STATe]	ON OFF		3.30
[:SOURce]:AM:EXTernal:COUPling	AC DC		3.30
[:SOURce]:AM:INTernal:FREQUency	0.1 Hz to 1MHz		3.30
[:SOURce]:AM:SOURce	EXT INT EXT, INT		3.30
[:SOURce]:AM:STATe	ON OFF		3.30
[:SOURce]:AM[:DEPTh]	0 to 100PCT		3.30
[:SOURce]:CORREction:CSET:CATalog?	⇒name, {name}...	not-SCPI	3.31
[:SOURce]:CORREction:CSET:DATA:FREQUency	300 kHz to 2.2/3.3 GHz {,300 kHz to 2.2/3.3 GHz}	not-SCPI	3.32
[:SOURce]:CORREction:CSET:DATA:POWer	-40dB to 6dB {,-40dB to 6dB}	not-SCPI	3.32
[:SOURce]:CORREction:CSET:DELeTe	'Name of table'	not-SCPI	3.32
[:SOURce]:CORREction:CSET[:SELeCt]	'Name of table'	not-SCPI	3.31
[:SOURce]:CORREction[:STATe]	ON OFF		3.31
[:SOURce]:DECT:CLOCK:DELaY	0 to 1.0	not-SCPI	3.36
[:SOURce]:DECT:CLOCK:SOURce	INTernal EXTernal		3.36
[:SOURce]:DECT:DLISt:CATalog?	⇒name, {name}...	not-SCPI	3.38
[:SOURce]:DECT:FILTer:PARAMeter	0.2 to 0.7	not-SCPI	3.35
[:SOURce]:DECT:FILTer:TYPE	GAUSSs SCOSine COSine	not-SCPI	3.35
[:SOURce]:DECT:FLISt:CATalog?	⇒name, {name}...	not-SCPI	3.38
[:SOURce]:DECT:FLISt:DELeTe	'name'	not-SCPI	3.38
[:SOURce]:DECT:FLISt:LOAD	'name'	not-SCPI	3.38
[:SOURce]:DECT:FLISt:PREDeFined:CATalog?	⇒name, {name}...	not-SCPI	3.38
[:SOURce]:DECT:FLISt:STORe	'Framelisten-Name'	not-SCPI	3.38
[:SOURce]:DECT:FLISt[:PREDeFined]:LOAD	'frame list name'	not-SCPI	3.38
[:SOURce]:DECT:FORMat	GFSK P4DQpsk	not-SCPI	3.35
[:SOURce]:DECT:FSK:DEVIation	1kHz to 300 kHz	not-SCPI	3.35
[:SOURce]:DECT:PRAMP:DELaY	-1.0 to +1.0	not-SCPI	3.37
[:SOURce]:DECT:PRAMP:FOFFset	-9 to +9	not-SCPI	3.37
[:SOURce]:DECT:PRAMP:PRESet		not-SCPI	3.37
[:SOURce]:DECT:PRAMP:ROFFset	-9 to +9	not-SCPI	3.37
[:SOURce]:DECT:PRAMP:SHAPE	LINear COSine	not-SCPI	3.37
[:SOURce]:DECT:PRAMP:TIME	0.25 to 16.0	not-SCPI	3.37
[:SOURce]:DECT:SEQUence	AUTO RETRigger AAUTO ARETrigger	not-SCPI	3.35

Command	Parameter	SCPI-Info	Page
[:SOURce]:DECT:SIMulation:JITTer	0 to 4 (in bit)	not-SCPI	3.38
[:SOURce]:DECT:SIMulation:TADJustment	-4 to +4 (in bit)	not-SCPI	3.37
[:SOURce]:DECT:SLOT:ATTenuation	0 to 70 dB	not-SCPI	3.37
[:SOURce]:DECT:SLOT<i>:LEVel	OFF ATT FULL	not-SCPI	3.39
[:SOURce]:DECT:SLOT<i>:PRAM:CW	ON OFF	not-SCPI	3.39
[:SOURce]:DECT:SLOT<i>:PRAM:DATA	0 to 111 to (12 bit)	not-SCPI	3.39
[:SOURce]:DECT:SLOT<i>:PREamble:DATA	0 to 111 to (16 bit)	not-SCPI	3.40
[:SOURce]:DECT:SLOT<i>:PREamble:PROLonged:DATA	0 to 111 to (32 bit)	not-SCPI	3.40
[:SOURce]:DECT:SLOT<i>:PREamble:TYPE	NORMal PROLonged	not-SCPI	3.39
[:SOURce]:DECT:SLOT<i>:PRESet		not-SCPI	3.39
[:SOURce]:DECT:SLOT<i>:SOURce:AFieLd	PN9 PN11 PN15 PN16 PN20 PN21 PN23 DLISt SDATa	not-SCPI	3.40
[:SOURce]:DECT:SLOT<i>:SOURce:AFieLd:DLISt	'name'	not-SCPI	3.40
[:SOURce]:DECT:SLOT<i>:SOURce:BFieLd	PN9 PN11 PN15 PN16 PN20 PN21 PN23 DLISt SDATa	not-SCPI	3.40
[:SOURce]:DECT:SLOT<i>:SOURce:BFieLd:DLISt	'name'	not-SCPI	3.40
[:SOURce]:DECT:SLOT<i>:STSHift	-9 to +9 (in bit)	not-SCPI	3.39
[:SOURce]:DECT:SLOT<i>:SYNC	#B0 to #B111 to (16bit)	not-SCPI	3.40
[:SOURce]:DECT:SLOT<i>:ZFieLd	ON OFF	not-SCPI	3.40
[:SOURce]:DECT:SLOT<i>:TYPE	FULL DOUBle ADATa	not-SCPI	3.39
[:SOURce]:DECT:SRATe	1kHz to 1.2 MHz	not-SCPI	3.35
[:SOURce]:DECT:STANdard		not-SCPI	3.35
[:SOURce]:DECT:STATe	ON OFF	not-SCPI	3.35
[:SOURce]:DECT:TRIGger:DELay	0 to 65535	not-SCPI	3.36
[:SOURce]:DECT:TRIGger:INHibit	0 to 67.1E6	not-SCPI	3.36
[:SOURce]:DECT:TRIGger:OUTPut[2]:DELay	0 to 11519	not-SCPI	3.36
[:SOURce]:DECT:TRIGger:OUTPut[2]:PERiod	1 to 67.1E6	not-SCPI	3.36
[:SOURce]:DECT:TRIGger:SOURce	EXTernal INTernal	not-SCPI	3.36
[:SOURce]:DM:CLISt:CATalog?		not-SCPI	3.48
[:SOURce]:DM:CLISt:CONTRol[:STATe]	ON OFF	not-SCPI	3.47
[:SOURce]:DM:CLISt:COpy	'<name>'	not-SCPI	3.48
[:SOURce]:DM:CLISt:DATA	<struc>{,<struc>}...	not-SCPI	3.47
[:SOURce]:DM:CLISt:DELete	'<name>'	not-SCPI	3.48
[:SOURce]:DM:CLISt:FREE?		not-SCPI	3.48
[:SOURce]:DM:CLISt:POINts?		not-SCPI	3.48
[:SOURce]:DM:CLISt:SELect	'<name>'	not-SCPI	3.48
[:SOURce]:DM:CLOCK:DELay	0 to 1.0	not-SCPI	3.52
[:SOURce]:DM:CLOCK:MODE	BIT SYMBol	not-SCPI	3.51
[:SOURce]:DM:CLOCK:POLarity	NORMal INVerted	not-SCPI	3.52
[:SOURce]:DM:CLOCK:SOURce	INTernal EXTernal COUPLed		3.51

Command	Parameter	SCPI-Info	Page
[.SOURce]:DM:CODing	OFF DIFF DPHS DGRay GSM NADC PDC PHS TETRa TFTS INmarsat APCO25 VDL	not-SCPI	3.51
[.SOURce]:DM:DLISt:CATalog?		not-SCPI	3.46
[.SOURce]:DM:DLISt:COpy	'<name>'	not-SCPI	3.47
[.SOURce]:DM:DLISt:DATA	0 1 {,0 1}..	not-SCPI	3.46
[.SOURce]:DM:DLISt:DATA:APPend	0 1 {,0 1}..	not-SCPI	3.46
[.SOURce]:DM:DLISt:DATA?	[<start> [,<length>]]	not-SCPI	3.46
[.SOURce]:DM:DLISt:DELeTe	'<name>'	not-SCPI	3.46
[.SOURce]:DM:DLISt:FREE?		not-SCPI	3.47
[.SOURce]:DM:DLISt:POINts	<n>	not-SCPI	3.47
[.SOURce]:DM:DLISt:SELeCt	'<name>'	not-SCPI	3.46
[.SOURce]:DM:FiLTer:MODE	LACP LEVM	not-SCPI	3.51
[.SOURce]:DM:FiLTer:PARAmeter	0.1 to 1.0	no query	3.51
[.SOURce]:DM:FiLTer:TYPE	SCOSine COSine GAUSs BESS1 BESS2 IS95 EIS95 APCO TETRa WCDMa	not-SCPI	3.51
[.SOURce]:DM:FORMat	BPSK QPSK QIS95 QINmarsat QICO OQPSk OIS95 P4QPSk P4DQpsk PSK8 GFSK GMSK FSK2 FSK4 AFSK4 QAM16 QAM32 QAM 64 QAM256 USER		3.50
[.SOURce]:DM:FSK:DEVIation	100Hz to 2.5 MHz	not-SCPI	3.50
[.SOURce]:DM:INPUt:IMPedance	G1K G50 ECL	not-SCPI	3.53
[.SOURce]:DM:IQ:IMPairment[:.STATe]	ON OFF	not-SCPI	3.41
[.SOURce]:DM:IQ:PRAMp	OFF AEXternal	not-SCPI	3.41
[.SOURce]:DM:IQ:STATe	ON OFF	not-SCPI	3.41
[.SOURce]:DM:IQRatio[:.MAGNitude]	-12.0 to 12.0 PCT		3.42
[.SOURce]:DM:IQSWap[:.STATe]	ON OFF	not-SCPI	3.42
[.SOURce]:DM:LDIStortion[:.STATe]	ON OFF	not-SCPI	3.52
[.SOURce]:DM:LEAKage[:.MAGNitude]	0 to 50.0 PCT		3.41
[.SOURce]:DM:MLISt:CATalog?		not-SCPI	3.49
[.SOURce]:DM:MLISt:DATA	A,B,C,D,E,F,I1,Q1,I2,Q2...	not-SCPI	3.49
[.SOURce]:DM:MLISt:DELeTe	'<name>'	not-SCPI	3.49
[.SOURce]:DM:MLISt:FREE?		not-SCPI	3.49
[.SOURce]:DM:MLISt:POINts?		not-SCPI	3.49
[.SOURce]:DM:MLISt:SELeCt	'<name>'	not-SCPI	3.49
[.SOURce]:DM:PATtern	ZERO ONE ALTErnate	not-SCPI	3.45
[.SOURce]:DM:PRAMp:ATTenuation	0 to 70dB	not-SCPI	3.53
[.SOURce]:DM:PRAMp:DELay	-1.0 to +5.0	not-SCPI	3.52
[.SOURce]:DM:PRAMp:SHAPE	LiNear COSine	not-SCPI	3.52
[.SOURce]:DM:PRAMp:SOURce	CLISt AEXternal DEXternal	not-SCPI	3.52
[.SOURce]:DM:PRAMp:TIME	0.25 to 32	not-SCPI	3.52

Command	Parameter	SCPI-Info	Page
[:SOURce]:DM:PRAMP[:STATe]	ON OFF	not-SCPI	3.52
[:SOURce]:DM:PRBS[:LENGth]	9 15 16 20 21 23	not-SCPI	3.45
[:SOURce]:DM:QUADrature:ANGLE	10.0 to 10.0 DEG		3.42
[:SOURce]:DM:SEQuence	AUTO RETRigger AAUto ARETrigger SINGLE	not-SCPI	3.45
[:SOURce]:DM:SOURce	PRBS PATTErn DLISt SERIal PARAllel SDATa		3.45
[:SOURce]:DM:SRATE	1kHz to 7 MHz	no query	3.50
[:SOURce]:DM:STANDard	APCFm APCQpsk CDPD CT2 DECT GSM IRIDIum NADC PDC PHS TETRa TFTS PWT ICOBpsk ICOGmsk ICOQpsk	not-SCPI	3.50
[:SOURce]:DM:STATe	ON OFF		3.45
[:SOURce]:DM:THReshold[:ALL]	-2.5 to 2.5 V		3.53
[:SOURce]:DM:TRIGger:DELay	0 to 65535	not-SCPI	3.53
[:SOURce]:DM:TRIGger:INHibit	0 to 67.1E6	not-SCPI	3.53
[:SOURce]:DM:TRIGger:SLOPe	POSitive NEGative	not-SCPI	3.53
[:SOURce]:DM:TRIGger:SOURce	EXTernal INTernal	not-SCPI	3.53
[:SOURce]:FM1 2[:DEViation]	0 to 1 MHz		3.54
[:SOURce]:FM1 2:EXTernal1 2:COUPLing	AC DC		3.54
[:SOURce]:FM1 2:INTernal:FREQuency	0.1 Hz to 1 MHz		3.55
[:SOURce]:FM1 2:PREEmphasis	0 50us 75us		3.55
[:SOURce]:FM1 2:SOURce	INTernal EXTernal1 EXTernal2		3.55
[:SOURce]:FM1 2:STATe	ON OFF		3.55
[:SOURce]:FREQuency:CENTer	300 kHz to 2.2/3.3 GHz		3.56
[:SOURce]:FREQuency[:CW]:FIXed]	300 kHz to 2.2/3.3 GHz		3.56
[:SOURce]:FREQuency[:CW]:FIXed]:RCL	INCLude EXCLude		3.56
[:SOURce]:FREQuency:MANual	300 kHz to 2.2/3.3 GHz		3.57
[:SOURce]:FREQuency:MODE	CW FIXed SWEep LIST		3.57
[:SOURce]:FREQuency:OFFSet	-50 to +50 GHz		3.57
[:SOURce]:FREQuency:SPAN	0 to 2.2/3.3 GHz		3.57
[:SOURce]:FREQuency:START	300 kHz to 2.2/3.3 GHz		3.57
[:SOURce]:FREQuency:STEP[:INCRement]	0 to 1 GHz		3.58
[:SOURce]:FREQuency:STOP	300 kHz to 2.2/3.3 GHz		3.58
[:SOURce]:FSIMulator:CONFigure	S6Path S12Path D6Path	not SCPI	3.58
[:SOURce]:FSIMulator:DEFault		not SCPI	3.58
[:SOURce]:FSIMulator:ILOSs:MODE	NORMal LACP	not SCPI	3.58
[:SOURce]:FSIMulator:PATH<i>[:CORRelation:COEFFicient]	0 to 1.0	not SCPI	3.58
[:SOURce]:FSIMulator:PATH<i>[:CORRelation:PATH	0 7 to 12	nicht SCPI	3.58
[:SOURce]:FSIMulator:PATH<i>[:CORRelation:PHASe	0 to 359 DEG	not SCPI	3.58
[:SOURce]:FSIMulator:PATH<i>[:DCOMponent:STATe	ON OFF	not SCPI	3.58
[:SOURce]:FSIMulator:PATH<i>[:DELay	0 to 1638.0 E-6 S	not SCPI	3.58

Command	Parameter	SCPI-Info	Page
[[:SOURce]:FSIMulator:PATH<i>:FDOPpler	0.1 to 1600 Hz	not SCPI	3.58
[[:SOURce]:FSIMulator:PATH<i>:FRATio	-1 to +1	not SCPI	3.58
[[:SOURce]:FSIMulator:PATH<i>:LOGNormal:CSTD	0 to 12.0 dB	not SCPI	3.58
[[:SOURce]:FSIMulator:PATH<i>:LOGNormal:LCONstant	0 to 99 999 (in m)	not SCPI	3.58
[[:SOURce]:FSIMulator:PATH<i>:LOGNormal:STATe	ON OFF	not SCPI	3.58
[[:SOURce]:FSIMulator:PATH<i>:LOSS	0 to 50.0 dB	not SCPI	3.58
[[:SOURce]:FSIMulator:PATH<i>:PRATio	-30 to +30 dB	not SCPI	3.58
[[:SOURce]:FSIMulator:PATH<i>:SPEed	0.005 to 27777 (in MPS; m/s)	not SCPI	3.58
[[:SOURce]:FSIMulator:PATH<i>:STATE	ON OFF	not SCPI	3.58
[[:SOURce]:FSIMulator:POWER?		not SCPI	3.58
[[:SOURce]:FSIMulator:SEQuence	RUN STOP	not SCPI	3.58
[[:SOURce]:FSIMulator:SEQuence:RESet		not SCPI	3.58
[[:SOURce]:FSIMulator:SPEed:UNIT	MPS KMPH MPH	not SCPI	3.58
[[:SOURce]:FSIMulator:STANdard	CDMA8 CDMA30 CDMA100 NADC8 NADC50 NADC100 GTU3 GTU50 GHT100 GRA250 GET50 GET100 PTU1 PTU50 PTU100 PHT100 PRA130 PET50 PET100 TTU THT TET	not SCPI	3.58
[[:SOURce]:FSIMulator[:STATe]	ON OFF	not SCPI	3.58
[[:SOURce]:GSM:CLOCK:DELay	0 to 1.0	not-SCPI	3.67
[[:SOURce]:GSM:CLOCK:SOURce	INTernal EXTernal		3.67
[[:SOURce]:GSM:DLISt:CATalog?	⇒name, {name}...	not-SCPI	3.69
[[:SOURce]:GSM:FILTer:PARAmeter	0.2 to 0.7	not-SCPI	3.66
[[:SOURce]:GSM:FLISt:CATalog?		not-SCPI	3.68
[[:SOURce]:GSM:FLISt:DELeTe	'name'	not-SCPI	3.69
[[:SOURce]:GSM:FLISt:LOAD	'name'	not-SCPI	3.68
[[:SOURce]:GSM:FLISt:PREDeFined:CATalog?	⇒name, {name}...	not-SCPI	3.68
[[:SOURce]:GSM:FLISt:STORe	'name'	not-SCPI	3.68
[[:SOURce]:GSM:FLISt[:PREDeFined]:LOAD	'name'	not-SCPI	3.68
[[:SOURce]:GSM:FORMat	GMSK GFSK	not-SCPI	3.66
[[:SOURce]:GSM:FSK:DEVIation	1kHz to 300 kHz	not-SCPI	3.66
[[:SOURce]:GSM:PRAMp:DELay	-1.0 to + 1.0	not-SCPI	3.67
[[:SOURce]:GSM:PRAMp:FOFFset	-9 to +9	not-SCPI	3.68
[[:SOURce]:GSM:PRAMp:PRESet		not-SCPI	3.67
[[:SOURce]:GSM:PRAMp:ROFFset	-9 to +9	not-SCPI	3.68
[[:SOURce]:GSM:PRAMp:SHAPE	LINear COSine	not-SCPI	3.67
[[:SOURce]:GSM:PRAMp:TIME	0.25 to 16.0	not-SCPI	3.67
[[:SOURce]:GSM:SEQuence	AUTO RETRigger AAUTO ARETrigger	not-SCPI	3.66
[[:SOURce]:GSM:SLOT:ATTenuation	0 to -70 dB	not-SCPI	3.68
[[:SOURce]:GSM:SLOT<i>:HOPPing:TRIGger	ON OFF	not-SCPI	3.69

Command	Parameter	SCPI-Info	Page
[:SOURce]:GSM:SLOT<i>:LEVel	OFF ATT FULL	not-SCPI	3.69
[:SOURce]:GSM:SLOT<i>:PRESet		not-SCPI	3.69
[:SOURce]:GSM:SLOT<i>:SF	0 1	not-SCPI	3.70
[:SOURce]:GSM:SLOT<i>:SOURce:DATA	PN9 PN15 PN16 PN20 PN21 PN23 DLISt SDATa	not-SCPI	3.69
[:SOURce]:GSM:SLOT<i>:SOURce:DATA:DLISt	'name'	not-SCPI	3.70
[:SOURce]:GSM:SLOT<i>:TSC	T0 to T7 USER	not-SCPI	3.70
[:SOURce]:GSM:SLOT<i>:TSC:USER	#B0 to #B1111 to (26 bits)	not-SCPI	3.70
[:SOURce]:GSM:SLOT<i>:TYPE	NORM DUMMy ADATa	not SCPI	3.69
[:SOURce]:GSM:SRATe	1kHz to 300 kHz	not-SCPI	3.66
[:SOURce]:GSM:STANdard		not-SCPI	3.65
[:SOURce]:GSM:STATe	ON OFF	not-SCPI	3.65
[:SOURce]:GSM:TRIGger:DELay	0 to 65535	not-SCPI	3.66
[:SOURce]:GSM:TRIGger:INHibit	0 to 67.1E6	not-SCPI	3.66
[:SOURce]:GSM:TRIGger:OUTPut[2]:DELay	0 to 1249	not-SCPI	3.66
[:SOURce]:GSM:TRIGger:OUTPut[2]:PERiod	1 to 67.1E6	not-SCPI	3.67
[:SOURce]:GSM:TRIGger:SOURce	EXTernal INTernal	not-SCPI	3.66
[:SOURce]:IS95:CHANnel<0 to 3>:POWER	-30 dB to 0 dB	not-SCPI	3.76
[:SOURce]:IS95:CHANnel<0 to 64>:STATe	ON OFF	not-SCPI	3.77
[:SOURce]:IS95:CHANnel<1 to 17>:WALShcode	0 to 63	not-SCPI	3.76
[:SOURce]:IS95:CHANnel<1 to 63>:DATA	ZERO ONE ALTErnate PRBS	not-SCPI	3.77
[:SOURce]:IS95:CLOCK:DELay	0 to 1.00	not-SCPI	3.75
[:SOURce]:IS95:CLOCK:SOURce	CHIP CHIP4 CHIP8 CHIP16	not-SCPI	3.75
[:SOURce]:IS95:CLOCK:SOURce	INTernal EXTernal		3.75
[:SOURce]:IS95:CRATe	1kHz to 7MHz	not-SCPI	3.72
[:SOURce]:IS95:DATA	ZERO ONE ALTErnate PRBS DLISt	not-SCPI	3.77
[:SOURce]:IS95:DLISt	'name'	not SCPI	3.77
[:SOURce]:IS95:DLISt:CATalog?		not SCPI	3.77
[:SOURce]:IS95:FILTer:FTYPE	SCOSine COSine IS95 EIS95	not-SCPI	3.73
[:SOURce]:IS95:FILTer:MODE	LACP LEVM	not-SCPI	3.73
[:SOURce]:IS95:FILTer:PARAmeter	0.1 to 0.7	not-SCPI	3.73
[:SOURce]:IS95:FILTer:RTYPE	SCOSine COSine IS95 EIS95	not-SCPI	3.73
[:SOURce]:IS95:LDISortion	ON OFF	not-SCPI	3.73
[:SOURce]:IS95:MAPPing:CATalog?		not-SCPI	3.76
[:SOURce]:IS95:MAPPing:DELeTe	'name'	not-SCPI	3.76
[:SOURce]:IS95:MAPPing:LOAD	'name'	not-SCPI	3.76
[:SOURce]:IS95:MAPPing:PREDeFined:CATalog?	⇒name, {name}...	not-SCPI	3.75
[:SOURce]:IS95:MAPPing:STORE	'name'	not-SCPI	3.76
[:SOURce]:IS95:MAPPing[:PREDeFined]:LOAD	'name'	not-SCPI	3.76

Command	Parameter	SCPI-Info	Page
[SOURce]:IS95:MODE	FLINK18 FLINK64 RLINK RLCoded	not-SCPI	3.72
[SOURce]:IS95:POWer:ADJust		no query	3.75
[SOURce]:IS95:POWer?		not-SCPI	3.75
[SOURce]:IS95:PRESet		not-SCPI	3.72
[SOURce]:IS95:RANDomizer	ON OFF	not-SCPI	3.77
[SOURce]:IS95:RATE	FULL HALF	not-SCPI	3.77
[SOURce]:IS95:RLCoded	TRAF14400 TRAF7200 TRAF3600 TRAF1800 ACC4800 TRAF9600 TRAF4800 TRAF2400 TRAF1200	not SCPI	3.78
[SOURce]:IS95:RLCoded	PN9 PN11 PN15 PN16 PN20 PN 21 PN23 DLIS1	not SCPI	3.78
[SOURce]:IS95:RLCoded:BINTerleaver	ON OFF	not SCPI	3.78
[SOURce]:IS95:RLCoded:CENCoder	ON OFF	not SCPI	3.78
[SOURce]:IS95:RLCoded:DLIS1	'name'	not SCPI	3.78
[SOURce]:IS95:RLCoded:EBIT	0 1	not SCPI	3.78
[SOURce]:IS95:RLCoded:FQINdicator	ON OFF	not SCPI	3.78
[SOURce]:IS95:SEQUence	AUTO RETRigger AAUTO ARETrigger	not-SCPI	3.74
[SOURce]:IS95:STATe	ON OFF	not-SCPI	3.72
[SOURce]:IS95:TRIGger:DELay	0 to 65535	not-SCPI	3.74
[SOURce]:IS95:TRIGger:INHibit	0 to 65535	not-SCPI	3.74
[SOURce]:IS95:TRIGger:OUTPut[1]2	TFRame SSRollover SFRame ESECond GATE	not-SCPI	3.74
[SOURce]:IS95:TRIGger:OUTPut[1]2:DELay	-32768 to 32768	not-SCPI	3.74
[SOURce]:IS95:TRIGger:OUTPut[1]2:POLarity	POSitive NEGative	not-SCPI	3.75
[SOURce]:IS95:TRIGger:SOURce	EXTernal INTernal	not-SCPI	3.74
[SOURce]:LIST:CATalog?		not-SCPI	3.78
[SOURce]:LIST:DELeTe	'Name of list'	not-SCPI	3.78
[SOURce]:LIST:DELeTe:ALL		not-SCPI	3.78
[SOURce]:LIST:DWELI	1 ms to 1 s {, 1 ms to 1 s}		3.78
[SOURce]:LIST:DWELI:POINts?			3.78
[SOURce]:LIST:FREE?			3.78
[SOURce]:LIST:FREQUency	300 kHz to 2.2/3.3 GHz {, 300 kHz to 3.3 GHz} block data		3.78
[SOURce]:LIST:FREQUency:POINts?			3.78
[SOURce]:LIST:LEARn		not-SCPI	3.78
[SOURce]:LIST:MODE	AUTO STEP	not-SCPI	3.78
[SOURce]:LIST:POWer	-144 to 16 dBm {, -144 to 16 dBm} block data		3.78
[SOURce]:LIST:POWer:POINts?			3.78
[SOURce]:LIST[:SElect]	'Name of list'	not SCPI	3.78
[SOURce]:MARKer1 2 3[:FSWEEP]:AMPLitude	ON OFF		3.82

Command	Parameter	SCPI-Info	Page
[[:SOURce]:MARKer1 2 3[:FSWeep]:AOFF			3.82
[[:SOURce]:MARKer1 2 3[:FSWeep]:FREQuency	300 kHz to 2.2/3.3 GHz		3.82
[[:SOURce]:MARKer1 2 3[:FSWeep][:STATe]	ON OFF		3.83
[[:SOURce]:MARKer1 2 3:PSWeep:AOFF		not-SCPI	3.83
[[:SOURce]:MARKer1 2 3:PSWeep:POWer	-144 dBm to +16 dBm	not-SCPI	3.83
[[:SOURce]:MARKer1 2 3:PSWeep[:STATe]	ON OFF	not-SCPI	3.83
[[:SOURce]:MARKer1 2 3:POLarity	NORMal INVerted	not-SCPI	3.83
[[:SOURce]:NADC:CLOCK:DELay	0 to 1.0	not-SCPI	3.87
[[:SOURce]:NADC:CLOCK:MODE	BIT SYMBol	not-SCPI	3.87
[[:SOURce]:NADC:CLOCK:SOURce	INTernal EXTernal		3.87
[[:SOURce]:NADC:DLISt:CATalog?	⇒name, {name}...	not-SCPI	3.90
[[:SOURce]:NADC:FILTer:MODE	LACP LEVM	not-SCPI	3.86
[[:SOURce]:NADC:FILTer:PARAmeter	0.1 to 0.7	not-SCPI	3.86
[[:SOURce]:NADC:FILTer:TYPE	SCOSine COSine	not-SCPI	3.86
[[:SOURce]:NADC:FLISt:CATalog?		not-SCPI	3.89
[[:SOURce]:NADC:FLISt:DELete	'name'	not-SCPI	3.90
[[:SOURce]:NADC:FLISt:LOAD	'name'	not-SCPI	3.89
[[:SOURce]:NADC:FLISt:PREDeFined:CATalog?	⇒name, {name}...	not-SCPI	3.89
[[:SOURce]:NADC:FLISt:STORe	'name'	not-SCPI	3.89
[[:SOURce]:NADC:FLISt[:PREDeFined]:LOAD	'name'	not-SCPI	3.89
[[:SOURce]:NADC:LDIStortion[:STATe]	ON OFF	not-SCPI	3.86
[[:SOURce]:NADC:LINK	UP DOWN	not-SCPI	3.88
[[:SOURce]:NADC:PRAMp:DELay	-1.0 to + 1.0	not-SCPI	3.88
[[:SOURce]:NADC:PRAMp:FOFFset	-9 to +9	not-SCPI	3.88
[[:SOURce]:NADC:PRAMp:PRESet		not-SCPI	3.88
[[:SOURce]:NADC:PRAMp:ROFFset	-9 to +9	not-SCPI	3.88
[[:SOURce]:NADC:PRAMp:SHAPE	LINear COSine	not-SCPI	3.88
[[:SOURce]:NADC:PRAMp:TIME	0.25 to 16.0	not-SCPI	3.88
[[:SOURce]:NADC:RCONfiguration	AHALf FULL1 FULL2 FULL3 FULL12 FULL13 FULL23 AFUL	not-SCPI	3.89
[[:SOURce]:NADC:SEQuence	AUTO RETRigger AAUTO ARETrigger	not-SCPI	3.86
[[:SOURce]:NADC:SLOT:ATTenuation	0 to -70 dB	not-SCPI	3.90
[[:SOURce]:NADC:SLOT<i>:CDVCC	#H0 to #HFFF (8 bit)	not-SCPI	3.91
[[:SOURce]:NADC:SLOT<i>:LEVel	OFF ATT FULL	not-SCPI	3.90
[[:SOURce]:NADC:SLOT<i>:PRESet		not-SCPI	3.90
[[:SOURce]:NADC:SLOT<i>:RSVD	#H800 to #HFFF (8 bit)	not-SCPI	3.91
[[:SOURce]:NADC:SLOT<i>:SOURce:DATA	PN9 PN11 PN15 PN16 PN20 PN21 PN23 DLISt SDATa	not-SCPI	3.91
[[:SOURce]:NADC:SLOT<i>:SOURce:DATA:DLISt	'name'	not-SCPI	3.91

Command	Parameter	SCPI-Info	Page
[[:SOURce]:NADC:SLOT<i>]:SOURce:SACChannel	PN9 PN11 PN15 PN16 PN20 PN21 PN23 DLISt SDATa	not-SCPI	3.91
[[:SOURce]:NADC:SLOT<i>]:SOURce:SACChannel:DLISt	'name'	not-SCPI	3.91
[[:SOURce]:NADC:SLOT<i>]:SYNC	#H0 to #FFFFFFF (28 bit)	not-SCPI	3.91
[[:SOURce]:NADC:SLOT<i>]:TYPE	TCH SHORt ADATa	not-SCPI	3.90
[[:SOURce]:NADC:SRATe	1kHz to 200 kHz	not-SCPI	3.86
[[:SOURce]:NADC:STANdard		not-SCPI	3.85
[[:SOURce]:NADC:STATe	ON OFF	not-SCPI	3.85
[[:SOURce]:NADC:TRIGger:DELay	0 to 65535	not-SCPI	3.87
[[:SOURce]:NADC:TRIGger:INHibit	0 to 67.1E6	not-SCPI	3.87
[[:SOURce]:NADC:TRIGger:OUTPut[2]:DELay	0 to 971	not-SCPI	3.87
[[:SOURce]:NADC:TRIGger:OUTPut[2]:PERiod	1 to 67.1E6	not-SCPI	3.87
[[:SOURce]:NADC:TRIGger:SOURce	EXTernal INTernal	not-SCPI	3.86
[[:SOURce]:PDC:CLOCK:DELay	0 to 1.0	not-SCPI	3.96
[[:SOURce]:PDC:CLOCK:MODE	BIT SYMBol	not-SCPI	3.95
[[:SOURce]:PDC:CLOCK:SOURce	INTernal EXTernal		3.95
[[:SOURce]:PDC:DLISt:CATalog?	⇒name, {name}...	not-SCPI	3.98
[[:SOURce]:PDC:FILTer:MODE	LACP LEVM	not-SCPI	3.94
[[:SOURce]:PDC:FILTer:PARAmeter	0.1 to 0.7	not-SCPI	3.94
[[:SOURce]:PDC:FILTer:TYPE	SCOSine COSine	not-SCPI	3.94
[[:SOURce]:PDC:FLISt:CATalog?		not-SCPI	3.97
[[:SOURce]:PDC:FLISt:DELete	'name'	not-SCPI	3.98
[[:SOURce]:PDC:FLISt:LOAD	'name'	not-SCPI	3.98
[[:SOURce]:PDC:FLISt:PREDeFined:CATalog?	⇒name, {name}...	not-SCPI	3.97
[[:SOURce]:PDC:FLISt:STORe	'name'	not-SCPI	3.98
[[:SOURce]:PDC:FLISt[:PREDeFined]:LOAD	'name'	not-SCPI	3.97
[[:SOURce]:PDC:LDIStortion[:STATe]	ON OFF	not-SCPI	3.94
[[:SOURce]:PDC:PRAMp:DELay	-1.0 to + 1.0	not-SCPI	3.96
[[:SOURce]:PDC:PRAMp:FOFFset	-9 to +9	not-SCPI	3.96
[[:SOURce]:PDC:PRAMp:PRESet		not-SCPI	3.96
[[:SOURce]:PDC:PRAMp:ROFFset	-9 to +9	not-SCPI	3.96
[[:SOURce]:PDC:PRAMp:SHAPE	LINear COSine	not-SCPI	3.96
[[:SOURce]:PDC:PRAMp:TIME	0.25 to 16.0	not-SCPI	3.96
[[:SOURce]:PDC:SEQUence	AUTO RETRigger AAUTO ARETrigger	not-SCPI	3.94
[[:SOURce]:PDC:SLOT:ATTenuation	0 to 70 dB	not-SCPI	3.96
[[:SOURce]:PDC:SLOT:LINK	UP DOWN	not-SCPI	3.97
[[:SOURce]:PDC:SLOT:RCONfiguration	AHALf FULL1 FULL2 FULL3 FULL12 FULL13 FULL23 AFUL	not-SCPI	3.97
[[:SOURce]:PDC:SLOT<i>]:CCODE	#H0 to #HFF (8 bits)	not-SCPI	3.101
[[:SOURce]:PDC:SLOT<i>]:E	0 1	not-SCPI	3.101

Command	Parameter	SCPI-Info	Page
[[:SOURce]:PDC:SLOT<i>]:LEVel	OFF ATT FULL	not-SCPI	3.98
[[:SOURce]:PDC:SLOT<i>]:POSTamble	#H0 to #H3FF... (78 bits)	not-SCPI	3.101
[[:SOURce]:PDC:SLOT<i>]:PREamble	#H0 to #H...(2/6/48/102 bits)	not-SCPI	3.101
[[:SOURce]:PDC:SLOT<i>]:PRESet		not-SCPI	3.99
[[:SOURce]:PDC:SLOT<i>]:SCRamble:STATe	ON OFF	not-SCPI	3.99
[[:SOURce]:PDC:SLOT<i>]:SFRame:RCHPosition	1 to 17	not-SCPI	3.99
[[:SOURce]:PDC:SLOT<i>]:SFRame:STATe	ON OFF	not-SCPI	3.99
[[:SOURce]:PDC:SLOT<i>]:SOURce:DATA	PN9 PN11 PN15 PN16 PN20 PN21 PN23 DLISt SDATa	not-SCPI	3.99
[[:SOURce]:PDC:SLOT<i>]:SOURce:DATA:DLISt	'name'	not-SCPI	3.100
[[:SOURce]:PDC:SLOT<i>]:SOURce:RCHannel	PN9 PN11 PN15 PN16 PN20 PN21 PN23 DLISt SDATa	not-SCPI	3.100
[[:SOURce]:PDC:SLOT<i>]:SOURce:RCHannel:DLISt	'name'	not-SCPI	3.100
[[:SOURce]:PDC:SLOT<i>]:SOURce:SACChannel	PN9 PN11 PN15 PN16 PN20 PN21 PN23 DLISt SDATa	not-SCPI	3.100
[[:SOURce]:PDC:SLOT<i>]:SOURce:SACChannel:DLISt	name'	not-SCPI	3.100
[[:SOURce]:PDC:SLOT<i>]:SOURce:SI	PN9 PN11 PN15 PN16 PN20 PN21 PN23 DLISt SDATa	not-SCPI	3.100
[[:SOURce]:PDC:SLOT<i>]:SOURce:SI:DLISt	'name'	not-SCPI	3.100
[[:SOURce]:PDC:SLOT<i>]:SYNC	#H1 to #H17	not-SCPI	3.101
[[:SOURce]:PDC:SLOT<i>]:SYNC2	#H0 to #HFF... (20/32 bits)	not-SCPI	3.101
[[:SOURce]:PDC:SLOT<i>]:TYPE	TCH SYNC VOX ADATa	not-SCPI	3.98
[[:SOURce]:PDC:SLOT<i>]:SCRamble:STARt	#H1 to #H1FF (9 bit)	not-SCPI	3.99
[[:SOURce]:PDC:SRATe	1kHz to 200 kHz	not-SCPI	3.94
[[:SOURce]:PDC:STANdard		not-SCPI	3.94
[[:SOURce]:PDC:STATe	ON OFF	not-SCPI	3.94
[[:SOURce]:PDC:TRIGger:DELay	0 to 65535	not-SCPI	3.95
[[:SOURce]:PDC:TRIGger:INHibit	0 to 67.1E6	not-SCPI	3.95
[[:SOURce]:PDC:TRIGger:OUTPut[2]:DELay	0 to 959	not-SCPI	3.95
[[:SOURce]:PDC:TRIGger:OUTPut[2]:PERiod	1 to 67.1M	not-SCPI	3.95
[[:SOURce]:PDC:TRIGger:SOURce	EXtErnal INtErnal	not-SCPI	3.95
[[:SOURce]:PHASe]:ADJust]	-360 deg to +360 deg	not-SCPI	3.102
[[:SOURce]:PHASe]:REFerence		not-SCPI	3.102
[[:SOURce]:PHS:CLOCK:DELay	0 to 1.0	not-SCPI	3.106
[[:SOURce]:PHS:CLOCK:MODE	BIT SYMBol	not-SCPI	3.106
[[:SOURce]:PHS:CLOCK:SOURce	INtErnal EXtErnal		3.106
[[:SOURce]:PHS:DLISt:CATalog?	⇒name, {name}...	not-SCPI	3.108
[[:SOURce]:PHS:FILTer:MODE	LACP LEVM	not-SCPI	3.105
[[:SOURce]:PHS:FILTer:PARAmeter	0.1 to 0.7	not-SCPI	3.105
[[:SOURce]:PHS:FILTer:TYPE	SCOSine COSine	not-SCPI	3.105
[[:SOURce]:PHS:FLISt:CATalog?		not-SCPI	3.108

Command	Parameter	SCPI-Info	Page
[[:SOURce]:PHS:FLISt:DELete	'name'	not-SCPI	3.108
[[:SOURce]:PHS:FLISt:LOAD	'name'	not-SCPI	3.108
[[:SOURce]:PHS:FLISt:PREDeFined:CATalog?	⇒name, {name}...	not-SCPI	3.107
[[:SOURce]:PHS:FLISt:STORe	'name'	not-SCPI	3.108
[[:SOURce]:PHS:FLISt[:PREDeFined]:LOAD	'name'	not-SCPI	3.108
[[:SOURce]:PHS:LDIStortion[:STATe]	ON OFF	not-SCPI	3.105
[[:SOURce]:PHS:PRAMp:DELay	-1.0 to + 1.0	not-SCPI	3.107
[[:SOURce]:PHS:PRAMp:FOFFset	-9 to +9	not-SCPI	3.107
[[:SOURce]:PHS:PRAMp:PRESet		not-SCPI	3.107
[[:SOURce]:PHS:PRAMp:ROFFset	-9 to +9	not-SCPI	3.107
[[:SOURce]:PHS:PRAMp:SHAPE	LINear COSine	not-SCPI	3.107
[[:SOURce]:PHS:PRAMp:TIME	0.25 to 16.0	not-SCPI	3.107
[[:SOURce]:PHS:SEQUence	AUTO RETRigger AAUTO ARETrigger	not-SCPI	3.105
[[:SOURce]:PHS:SLOT:ATTenuation	0 to 70 dB	not-SCPI	3.108
[[:SOURce]:PHS:SLOT<i>:CSID	#HO to #H3FFFFFFFF	not-SCPI	3.110
[[:SOURce]:PHS:SLOT<i>:ENCRyption:KEY	#HO to #HFFFF	not-SCPI	3.109
[[:SOURce]:PHS:SLOT<i>:ENCRyption:STATe	ON OFF	not-SCPI	3.109
[[:SOURce]:PHS:SLOT<i>:IDLe	#HO to #HFFFFFF	not-SCPI	3.110
[[:SOURce]:PHS:SLOT<i>:LEVel	OFF ATT FULL	not-SCPI	3.109
[[:SOURce]:PHS:SLOT<i>:PRESet		not-SCPI	3.109
[[:SOURce]:PHS:SLOT<i>:PSID	#HO to #HFFFFFF	not-SCPI	3.110
[[:SOURce]:PHS:SLOT<i>:SCRamble:STATe	ON OFF	not-SCPI	3.109
[[:SOURce]:PHS:SLOT<i>:SOURce:SACChannel	PN9 PN11 PN15 PN16 PN20 PN21 PN23 DLISt SDATa	not-SCPI	3.110
[[:SOURce]:PHS:SLOT<i>:SOURce:SACChannel:DLISt	'name'	not-SCPI	3.110
[[:SOURce]:PHS:SLOT<i>:SOURce:TCH	PN9 PN15 PN16 PN20 PN21 PN23 DLISt SDATa	not-SCPI	3.110
[[:SOURce]:PHS:SLOT<i>:SOURce:TCHannel:DLISt	'name'	not-SCPI	3.110
[[:SOURce]:PHS:SLOT<i>:TYPE	TCHFull TCHHalf SYNC VOX ADATa	not-SCPI	3.109
[[:SOURce]:PHS:SLOT<i>:UWORD	#HO to #HFFFFFF	not-SCPI	3.110
[[:SOURce]:PHS:SLOT<i>:SCRamble:CODE	#HO to #H3FF	not-SCPI	3.109
[[:SOURce]:PHS:SRATe	1kHz to 200 kHz	not-SCPI	3.105
[[:SOURce]:PHS:STANdard		not-SCPI	3.105
[[:SOURce]:PHS:STATe	ON OFF	not-SCPI	3.104
[[:SOURce]:PHS:TRIGger:DELay	0 to 65535	not-SCPI	3.106
[[:SOURce]:PHS:TRIGger:INHibit	0 to 67.1E6	not-SCPI	3.106
[[:SOURce]:PHS:TRIGger:OUTPut[2]:DELay	0 to 959	not-SCPI	3.106
[[:SOURce]:PHS:TRIGger:OUTPut[2]:PERiod	1 to 67.1E6	not-SCPI	3.106
[[:SOURce]:PHS:TRIGger:SOURce	EXTernal INTernal	not-SCPI	3.105

Command	Parameter	SCPI-Info	Page
[[:SOURce]:PM1 2[:DEViation]	-360 to +360 deg		3.111
[[:SOURce]:PM1 2:EXTErnal1 2:COUPLing	AC DC		3.111
[[:SOURce]:PM1 2:INTernAl:FREQuency	0.1 Hz to 1 MHz		3.112
[[:SOURce]:PM1 2:SOURce	INTernAl EXTErnal1 EXTErnal2		3.112
[[:SOURce]:PM1 2:STATe	ON OFF		3.112
[[:SOURce]:POWER:ALC:SEARCh	ON OFF ONCE		3.114
[[:SOURce]:POWER:ALC:TABLE[:MEASure]?]			3.113
[[:SOURce]:POWER:ALC:STATe]	ON OFF AUTO		3.113
[[:SOURce]:POWER[:LEVel][:IMMEDIATE][:AMPL]:OFFSet	-100 to +100		3.114
[[:SOURce]:POWER[:LEVel][:IMMEDIATE][:AMPLitude]	-144 to +16 dBm		3.114
[[:SOURce]:POWER[:LEVel][:IMMEDIATE][:AMPLitude]:RCL	INCLude EXCLude		3.114
[[:SOURce]:POWER:LIMit[:AMPLitude]	-144 to +16 dBm		3.115
[[:SOURce]:POWER:MANual	-144 to + 16 dBm		3.115
[[:SOURce]:POWER:MODE	FIXed SWEEp LIST		3.115
[[:SOURce]:POWER:PEP?			3.115
[[:SOURce]:POWER:START	-144 to +16 dBm		3.115
[[:SOURce]:POWER:STEP[:INCRement]	0.1 to 10 dB		3.115
[[:SOURce]:POWER:STOP	-144 to +16 dBm		3.115
[[:SOURce]:PULM:POLarity	NORMal INVERTed		3.116
[[:SOURce]:PULM:STATe	ON OFF		3.116
[[:SOURce]:ROSCillator:EXTErnal:FREQuency	1 to 16 MHz		3.117
[[:SOURce]:ROSCillator[:INTernAl]:ADJusT[:STATe]	ON OFF	not-SCPI	3.117
[[:SOURce]:ROSCillator[:INTernAl]:ADJusT:VALue	0 to 4095	not-SCPI	3.117
[[:SOURce]:ROSCillator:SOURce	INTernAl EXTErnal	not-SCPI	3.117
[[:SOURce]:SWEEp:BTIMe	NORMal LONG	not-SCPI	3.118
[[:SOURce]:SWEEp[:FREQuency]:DWELI	10 ms to 5 s	not-SCPI	3.118
[[:SOURce]:SWEEp[:FREQuency]:MODE	AUTO MANual STEP	not-SCPI	3.119
[[:SOURce]:SWEEp[:FREQuency]:POINts	Number	not-SCPI	3.119
[[:SOURce]:SWEEp[:FREQuency]:SPACing	LINear LOGarithmic	not-SCPI	3.119
[[:SOURce]:SWEEp[:FREQuency]:STEP:LOGarithmic	0.01 to 50 PCT	not-SCPI	3.119
[[:SOURce]:SWEEp[:FREQuency]:STEP[:LINear	0 to 1 GHz	not-SCPI	3.119
[[:SOURce]:SWEEp:POWER:DWELI	1 ms to 5 s	not-SCPI	3.120
[[:SOURce]:SWEEp:POWER:MODE	AUTO MANual STEP	not-SCPI	3.120
[[:SOURce]:SWEEp:POWER:STEP[:LOGarithmic]	0 to 10 dB	not-SCPI	3.120
:SOURce2:FREQuency[:CW :FIXed]	40.1 Hz to 1 MHz		3.121
:SOURce2:FREQuency:MANual	0.1 Hz to 1 MHz		3.121
:SOURce2:FREQuency:MODE	CW FIXed SWEEp		3.122
:SOURce2:FREQuency:START	0.1 Hz to 1 MHz		3.122
:SOURce2:FREQuency:STOP	0.1 Hz to 1 MHz		3.122
:SOURce2:MARKer1 2 3[:FSWEEp]:AOFF			3.123

Command	Parameter	SCPI-Info	Page
:SOURce2:MARKer1 2 3[:FSWeep]:FREQuency	0.1 Hz to 1 MHz		3.123
:SOURce2:MARKer1 2 3[:FSWeep][:STATe]	ON OFF		3.123
:SOURce2:MARKer1 2 3:POLarity	NORMal INVerted	not-SCPI	3.123
:SOURce2:SWEep:BTIMe	NORMal LONG	not-SCPI	3.124
:SOURce2:SWEep[:FREQuency]:DWELI	1 ms to 1 s	not-SCPI	3.124
:SOURce2:SWEep[:FREQuency]:MODE	AUTO MANual STEP	not-SCPI	3.124
:SOURce2:SWEep[:FREQuency]:POINts	Number	not-SCPI	3.125
:SOURce2:SWEep[:FREQuency]:SPACing	LINear LOGarithmic	not-SCPI	3.125
:SOURce2:SWEep[:FREQuency]:STEP[:LINear]	0 to 500 kHz	not-SCPI	3.125
:SOURce2:SWEep[:FREQuency]:STEP:LOGarithmic	0.01 to 50PCT	not-SCPI	3.125
:STATus:OPERation:CONDition?			3.126
:STATus:OPERation:ENABle	0 to 32767		3.127
:STATus:OPERation[:EVENT]?			3.126
:STATus:OPERation:NTRansition	0 to 32767		3.126
:STATus:OPERation:PTRansition	0 to 32767		3.126
:STATus:PRESet			3.127
:STATus:QUESTionable:CONDition?			3.127
:STATus:QUESTionable:ENABle	0 to 32767		3.127
:STATus:QUESTionable[:EVENT]?			3.127
:STATus:QUESTionable:NTRansition	0 to 32767		3.127
:STATus:QUESTionable:PTRansition	0 to 32767		3.127
:STATus:QUEue [:NEXT]?			3.127
:SYSTem:BEEPer:STATe	ON OFF		3.129
:SYSTem:COMMunicate:GPIB:LTERminator	EOI STANDard		3.129
:SYSTem:COMMunicate:GPIB[:SELF]:ADDRess	1 to 30		3.129
:SYSTem:COMMunicate:SDATa:BAUD	1200 2400 4800 9600 19200 38400 57600 115200		3.129
:SYSTem:COMMunicate:SERial:BAUD	1200 2400 4800 9600 19200 38400 57600 115200		3.129
:SYSTem:COMMunicate:SERial:CONTRol:RTS	ON IBFull RFR		3.129
:SYSTem:COMMunicate:SERial:PACe	XON NONE		3.130
:SYSTem:ERRor?			3.130
:SYSTem:KLOCK	ON OFF		3.130
:SYSTem:MODE	FIXed MSEQence	not-SCPI	3.130
:SYSTem:MSEQuence:CATalog?		not-SCPI	3.130
:SYSTem:MSEQuence:DELeTe	'Name of sequence'	not-SCPI	3.131
:SYSTem:MSEQuence:DELeTe:ALL		not-SCPI	3.131
:SYSTem:MSEQuence:DWELI	50 ms to 60 s{,50 ms to 60 s}	not-SCPI	3.131
:SYSTem:MSEQuence:FREe?		not-SCPI	3.131
:SYSTem:MSEQuence:MODE	AUTO STEP	not-SCPI	3.131
:SYSTem:MSEQuence[:RCL]	1 to 50 {,1 to 50}	not-SCPI	3.131

Command	Parameter	SCPI-Info	Page
:SYSTem:MSEquence[:RCL]:POINts?		not-SCPI	3.131
:SYSTem:MSEquence:SElect	'Name of sequence'	not-SCPI	3.132
:SYSTem:PRESet			3.132
:SYSTem:PROTEct1 2 3[:STATe]	ON OFF, password	not-SCPI	3.132
:SYSTem:SECurity[:STATe]	ON OFF		3.132
:SYSTem:SERRor?		not-SCPI	3.133
:SYSTem:SSAVe	1 to 1000	not-SCPI	3.133
:SYSTem:SREStore	1 to 1000	not-SCPI	3.133
!	<least sign. byte><most sign. byte>	not-SCPI	3.133
:SYSTem:VERSIon?		not-SCPI	3.133
:TEST:BATTery:DGEN?			3.135
:TEST:BATTery[:RAM]?			3.135
:TEST:DIRect:ATTC	Subaddress {,hex data string}	not-SCPI	3.134
:TEST:DIRect:DGEN	Subaddress {,hex data string}		3.135
:TEST:DIRect:DSYNOMUX	Subaddress {,hex data string}		3.135
:TEST:DIRect:DSYN1MUX	Subaddress {,hex data string}		3.135
:TEST:DIRect:FMOD	Subaddress {,hex data string}		3.135
:TEST:DIRect:FSIMA	Subaddress {,hex data string}		3.135
:TEST:DIRect:IQCON	Subaddress {,hex data string}		3.135
:TEST:DIRect:IQMOD	Subaddress {,hex data string}		3.135
:TEST:DIRect:REFSS	Subaddress {,hex data string}		3.135
:TEST:DIRect:ROSC	Subaddress {,hex data string}		3.135
:TEST:DIRect:SUM	Subaddress {,hex data string}		3.135
:TEST:FSIM	Subaddress {,hex data string}		3.135
:TEST:RAM?			3.135
:TEST:ROM?			3.135
:TRIGger:LIST[:IMMediate]		not-SCPI	3.137
:TRIGger:LIST:SOURce	AUTO SINGle EXTernal HOP	not-SCPI	3.137
:TRIGger:SLOPe		not-SCPI	3.138
:TRIGger:MSEquence[:IMMediate]		not-SCPI	3.138
:TRIGger:MSEquence:SOURce	AUTO SINGle EXTernal	not-SCPI	3.138
:TRIGger1 2[:SWEep][:IMMediate]		not-SCPI	3.136
:TRIGger1 2[:SWEep]:SOURce	AUTO SINGle EXTernal	not-SCPI	3.136
:UNIT:ANGLE	DEGRee DEGree RADian		3.139
:UNIT:POWER	DBM DBW DBMW DBUW DBV DBMV DBUV V		3.139



Annex D

Programming Examples

The examples explain the programming of the instrument and can serve as a basis to solve more complex programming tasks.

QuickBASIC has been used as programming language. However, the programs can be translated into other languages.

1. Including IEC-Bus Library for QuickBasic

```
REM ----- Include IEC-bus library for quickbasic -----
'$INCLUDE: 'c:\qbasic\qbdecl4.bas
```

2. Initialization and Default Status

The IEC bus as well as the settings of the instrument are brought into a defined default status at the beginning of every program. Subroutines "InitController" and "InitDevice" are used to this effect.

2.1. Initiate Controller

```
REM ----- Initiate Instrument -----
REM InitController
ieaddress% = 28                'IEC-bus address of the instrument
CALL IBFIND("DEV1", generator%) 'Open port to the instrument
CALL IBPAD(generator%, ieaddress%) 'Inform controller on instrument address
CALL IBTMO(generator%, 11)      'Response time to 1 sec
REM *****
```

2.2. Initiate Instrument

The IEC-bus status registers and instrument settings of the SMIQ are brought into the default status.

```
REM ----- Initiate Instrument -----
REM InitDevice
CALL IBWRT(generator%, "*CLS") 'Reset status register
CALL IBWRT(generator%, "*RST") 'Reset instrument
CALL IBWRT(generator%, "OUTPUT ON") 'Switch on RF output
REM *****
```

3. Transmission of Instrument Setting Commands

Output frequency, output level and AM modulation are set in this example. The settings correspond to the sample setting for first users in manual control. By analogy to the step width setting of the rotary knob, the step width is additionally set for the alteration of the RF frequency in the case of UP and DOWN.

```

REM ----- Instrument setting commands -----
CALL IBWRT(generator%, "FREQUENCY 250E6")           'RF Frequency 250 MHz
CALL IBWRT(generator%, "POWER -10")                'Output power -10 dBm
CALL IBWRT(generator%, "AM 80")                    'AM with modulation index of 80%
CALL IBWRT(generator%, "AM:INTERNAL1:FREQUENCY 3KHZ") 'Modulation frequency 3kHz
CALL IBWRT(generator%, "AM:SOURCE INT")            'Modulation source LF generator 1
CALL IBWRT(generator%, "FREQUENCY:STEP 12500")     'Step width RF frequency 12.5kHz
REM *****
    
```

4. Switchover to Manual Control

```

REM ----- Switch instrument over to manual control -----
CALL IBLOC(generator%)                             'Set instrument to Local state
REM *****
    
```

5. Reading out Instrument Settings

The settings made in example 3 are read out here. The abbreviated commands are used.

```

REM ----- Reading out instrument settings -----
RFfrequency$ = SPACE$(20)                          'Provide text variables with 20 characters
CALL IBWRT(generator%, "FREQ?")                     'Request frequency setting
CALL IBRD(generator%, RFfrequency$)                 'Read value

RFlevel$ = SPACE$(20)                              'Provide text variables with 20 characters
CALL IBWRT(generator%, "POW?")                      'Request level setting
CALL IBRD(generator%, RFlevel$)                    'Read value

AMmodulationdepth$ = SPACE$(20)                    'Provide text variables with 20 characters
CALL IBWRT(generator%, "AM?")                       'Request setting of modulation depth
CALL IBRD(generator%, AMmodulationdepth$)           'Read value

AMfrequency$ = SPACE$(20)                          'Provide text variables with 20 characters
CALL IBWRT(generator%, "AM:INT:FREQ?")              'Request modulation frequency setting
CALL IBRD(generator%, AMfrequency$)                 'Read value

Stepwidth$ = SPACE$(20)                            'Provide text variables with 20 characters
CALL IBWRT(generator%, "FREQ:STEP?")                'Request step width setting
CALL IBRD(generator%, stepwidth$)                   'Read value

REM ----- Display values on the screen -----
PRINT "RF frequency: "; RFfrequency$,
PRINT "RF level: "; RFlevel$,
PRINT "AM modulationdepth: "; AMmodulationdepth$,
PRINT "AM frequency: "; AMfrequency$,
PRINT "Step width: "; stepwidth$
REM *****
    
```

6. List Management

```

REM ----- Example of list management -----CALL
IBWRT(generator%, "SYST:MSEQ:SELECT "+CHR$(34)+"MSEQ1"+CHR$(34))
                                'Select list "MSEQ1", is generated if necessary
CALL IBWRT(generator%, "SYST:MSEQ: 1,3,7,2,5,7,7)          'Fill RCL list with values
CALL IBWRT(generator%, "SYST:MSEQ:DWELL 0.2")              '200ms per step
CALL IBWRT(generator%, "TRIGGER:MSEQ:SOURCE AUTO")         'Permanently repeat MSEQ automatically
CALL IBWRT(generator%, "SYST:MODE MSEQ")                  'Switch over instrument to MSEQ mode
REM *****

```

7. Command synchronization

The possibilities for synchronization implemented in the following example are described in Section Command Order and Command Synchronization.

```

REM ----- Examples of command synchronization -----
REM Command ROSCILLATOR:SOURCE INT has a relatively long execution time
REM (over 300ms). It is to be ensured that the next command is only executed
REM when the reference oscillator has settled.

REM First possibility: Use of *WAI -----
CALL IBWRT(generator%, "ROSCILLATOR:SOURCE INT; *WAI; :FREQUENCY 100MHZ")

REM Second possibility: Use of *OPC? -----
OpcOk$ = SPACES(2)
CALL IBWRT(generator%, "ROSCILLATOR:SOURCE INT; *OPC?")
REM ----- here the controller can service other instruments -----
CALL IBRD(generator%, OpcOk$)
                                'Wait for "1" from *OPC?

REM Third possibility: Use of *OPC
REM In order to be able to use the service request function in conjugation with a National
REM Instruments GPIB driver, the setting "Disable Auto Serial Poll" must be changed to "yes"
REM by means of IBCONF.
CALL IBWRT(generator%, "**SRE 32")
                                'Permit service request for ESR
CALL IBWRT(generator%, "**ESE 1")
                                'Set event-enable bit for operation-complete bit
ON PEN GOSUB OpcReady
                                'Initialization of the service request routine
PEN ON
CALL IBWRT(generator%, "ROSCILLATOR:SOURCE INT; *OPC")
REM Continue main program here
STOP
                                'End of program

OpcReady:
REM As soon as the reference oscillator has settled, this subroutine is activated
REM Program suitable reaction to the OPC service request.
ON PEN GOSUB OpcReady
                                'Enable SRQ routine again
RETURN
REM *****

```

8. Service Request

The service request routine requires an extended initialization of the instrument in which the respective bits of the transition and enable registers are set.

In order to be able to use the service request function in conjugation with a National Instruments GPIB driver, the setting "Disable Auto Serial Poll" must be changed to "yes" by means of IBCONF.

```

REM ----- Example of initialization of the SRQ in the case of errors -----
CALL IBWRT(generator%, "*CLS")           'Reset status reporting system
CALL IBWRT(generator%, "*SRE 168")      'Permit service request for STAT:OPER-,
                                        'STAT:QUES- and ESR register
CALL IBWRT(generator%, "*ESE 60")      'Set event-enable bit for command, execution,
                                        'device-dependent and query error
CALL IBWRT(generator%, "STAT:OPER:ENAB 32767") 'Set OPERATION enable bit for all events
CALL IBWRT(generator%, "STAT:OPER:PTR 32767") 'Set appropriate OPERATION Ptransition bits
CALL IBWRT(generator%, "STAT:OPER:ENAB 32767") 'Set questionable enable bits for all events
CALL IBWRT(generator%, "STAT:OPER:PTR 32767") 'Set appropriate questionable Ptransition bits
ON PEN GOSUB Srq                        'Initialization of the service request routine
PEN ON
REM Continue main program here
STOP                                     'End of program

```

A service request is then processed in the service request routine.

Note: The variables *userN%* and *userM%* must be pre-assigned usefully.

```

Srq:
REM ----- Service request routine -----
DO
SRQFOUND% = 0
FOR I% = userN% TO userM%              'Poll all bus users
ON ERROR GOTO nouser                   'No user existing
CALL IBRSP(I%, STB%)                  'Serial poll, read status byte
IF STB% > 0 THEN                        'This instrument has bits set in the STB
SRQFOUND% = 1
IF (STB% AND 16) > 0 THEN GOSUB Outputqueue
IF (STB% AND 4) > 0 THEN GOSUB Failure
IF (STB% AND 8) > 0 THEN GOSUB Questionablestatus
IF (STB% AND 128) > 0 THEN GOSUB Operationstatus
IF (STB% AND 32) > 0 THEN GOSUB Esrread
END IF
nouser:
NEXT I%
LOOP UNTIL SRQFOUND% = 0
ON ERROR GOTO error handling
ON PEN GOSUB Srq: RETURN                'Enable SRQ routine again;
'End of SRQ routine

```

Reading out the status event registers, the output buffer and the error/event queue is effected in subroutines.

```

REM ----- Subroutines for the individual STB bits -----
Outputqueue:                                     'Reading the output buffer
Message$ = SPACE$(100)                          'Make space for response
CALL IBRD(generator%, Message$)
PRINT "Message in output buffer :"; Message$
RETURN

Failure:                                         'Read error queue
ERROR$ = SPACE$(100)                             'Make space for error variable
CALL IBWRT(generator%, "SYSTEM:ERROR?")
CALL IBRD(generator%, ERROR$)
PRINT "Error text :"; ERROR$
RETURN

Questionablestatus:                             'Read questionable status register
Ques$ = SPACE$(20)                               'Preallocate blanks to text variable
CALL IBWRT(generator%, "STATUS:QUESTIONABLE:EVENT?")
CALL IBRD(generator%, Ques$)
IF (VAL(Ques$) AND 128) > 0 THEN PRINT "Calibration ?" 'Calibration is questionable
IF (VAL(Ques$) AND 1) > 0 THEN PRINT "Voltage ?"      'Output level is questionable
RETURN

Operationstatus:                                'Read operation status register
Oper$ = SPACE$(20)                              'Preallocate blanks to text variable
CALL IBWRT(generator%, "STATUS:OPERATION:EVENT?")
CALL IBRD(generator%, Oper$)
IF (VAL(Oper$) AND 1) > 0 THEN PRINT "Calibration"
IF (VAL(Oper$) AND 2) > 0 THEN PRINT "Settling"
IF (VAL(Oper$) AND 8) > 0 THEN PRINT "Sweeping"
IF (VAL(Oper$) AND 32) > 0 THEN PRINT "Wait for trigger"
RETURN

Esrread:                                         'Read event status register
Esr$ = SPACE$(20)                               'Preallocate blanks to text variable
CALL IBWRT(generator%, "*ESR?")                 'Read ESR
CALL IBRD(generator%, Esr$)
IF (VAL(Esr$) AND 1) > 0 THEN PRINT "Operation complete"
IF (VAL(Esr$) AND 4) > 0 THEN GOTO Failure
IF (VAL(Esr$) AND 8) > 0 THEN PRINT "Device dependent error"
IF (VAL(Esr$) AND 16) > 0 THEN GOTO Failure
IF (VAL(Esr$) AND 32) > 0 THEN GOTO Failure
IF (VAL(Esr$) AND 64) > 0 THEN PRINT "User request"
IF (VAL(Esr$) AND 128) > 0 THEN PRINT "Power on"
RETURN
REM *****

REM ----- Error routine -----
Error handling:
PRINT "ERROR"                                     'Output error message
STOP                                              'Stop software

```

The first part of the document discusses the importance of maintaining accurate records of all transactions. It emphasizes that every entry should be supported by a valid receipt or invoice. This not only helps in tracking expenses but also ensures compliance with tax regulations.

In the second section, the author outlines the various methods used for data collection and analysis. These include surveys, interviews, and focus groups. Each method has its own strengths and weaknesses, and the choice depends on the specific research objectives.

The third section provides a detailed overview of the results obtained from the study. It includes several tables and graphs that illustrate the key findings. The data shows a clear trend towards digital marketing strategies among small businesses.

Finally, the document concludes with a series of recommendations for future research and practical applications. It suggests that further studies should explore the long-term impact of these digital marketing strategies and how they evolve over time.



Index

A

A field (DECT) 2.205; 3.40
 Abort actions triggered 3.17
 Active edge (external trigger) 2.252; 3.138
 dig. mod. 2.103; 3.53
 Address
 IEC/IEEE bus 2.234; 3.129
 Addressed commands 6A.3
 ALC TABLE- calibration 2.245; 3.113
 AM
 distortion factor 5.26
 frequency 2.58; 3.30
 frequency response 5.25
 modulation depth 5.25
 residual PhiM 5.26
 Amplitude marker (RF-sweep) 2.221; 3.82
 Amplitude modulation (AM) 2.58; 3.30
 ASCII character # 3.11
 Asterix 3.11
 Attenuator 2.48
 mode fixed 5.23
 Attenuator (slot) 1.5
 Attenuator circuits
 indication 2.250

B

B field (DECT) 2.205; 3.40
 Base station
 CDMA 2.118
 DECT 2.191
 GSM 2.177
 NADC 2.137
 PDC 2.155
 PHS 2.104
 Battery test
 data generator 4.2
 RAM 4.2
 Baud rate
 RS232 2.235; 3.129; 6A.5
 SERDATA 2.236; 3.129
 BB-AM 2.59; 3.30
 BB-AM output 2.11
 Beeper 2.253; 3.129
 BER measurement
 DECT 2.192
 GSM 2.178
 NADC 2.138
 PDC 2.156
 PHS 2.105
 Bit clock
 dig. mod. 2.100; 3.51
 DECT 2.199; 3.36
 NADC 2.145; 3.87
 PDC 2.162; 3.95
 PHS 2.112; 3.106
 BIT CLOCK input/output 2.11; 2.85; 3.53
 BITCLK output 2.17
 BLANK output 2.13; 2.218; 2.224; 2.252
 Blank time 2.252; 3.118
 Block data 3.24
 Boolean parameter 3.9
 Brief instructions 3.1

Brightness
 control (oscilloscope) 2.219
 display 1.2; 2.9
 Broadband amplitude modulation (BB-AM) 2.59; 3.30; 5.27
 Broadband noise 5.17
 BURST GATE input/output 2.17
 Burst gate signal (dig. mod.) 2.83; 2.101; 3.48
 BxT rate (dig. mod.) 2.97; 3.51

C

Calibration
 ALC TABLE 2.245; 3.113
 disable 3.132
 FADING SIM 2.246; 3.18
 LEV ATT 2.246; 3.18
 LEV PRESET 2.244; 3.19
 LEVEL 2.241; 3.19
 password 2.241; 3.132
 REF OSC 2.241; 3.19
 VCO SUM 2.242; 3.19
 VECTOR MOD 2.243; 3.20
 Carrier frequency deviation with FM 5.37
 Caution messages 2.256
 CDMA 2.118; 3.71
 CDVCC (NADC) 2.150
 Cell station (CS)
 DECT 2.191
 GSM 2.177
 NADC 2.137
 PDC 2.155
 PHS 2.104
 Center frequency (RF sweep) 2.220; 3.56
 Channel (CDMA) 2.132; 3.76
 Character data 3.8
 Checksum
 control list 4.2
 data list 4.2
 Chip clock (CDMA) 2.130; 3.75
 Chip rate (CDMA) 2.126; 3.72
 CI - Channel Identifier-data field (PHS) 2.117
 Cleaning the outside 4.1
 Clock source
 CDMA 2.130; 3.75
 DECT 2.199; 3.36
 dig. mod. 2.100; 3.51
 GSM 2.184; 3.67
 NADC 2.144; 3.87
 PDC 2.162; 3.95
 PHS 2.112; 3.106
 CMOS-RAM 1.2
 Coding (dig. mod.) 2.77; 2.94; 2.97; 3.51
 Colon 3.11
 Color code data field (PDC) 2.168; 2.176
 Combination of modulation methods (dig. mod.) 2.77
 Comma 3.11
 Command
 addressed 6A.3
 line structure 3.8
 list 8C.1
 parameter 3.9
 recognition 3.141
 sequence 3.142

structure 3.6
 synchronization 3.142
 syntax elements 3.11
 universal 6A.3
Common Commands
 Condition register 3.144
 Contrast (display) 1.2; 2.9
 Control list (dig. mod.) 2.83; 2.93; 3.47
 check sum 4.2
 Correlation (fad. sim.) 2.74; 3.58
 Counter 2.250; 3.22
Coupling
 EXT1 (AM) 2.58; 3.30
 EXT1/2
 FM 2.60; 3.54
 PM 2.62; 3.111
 CRC (Cyclic Redundancy Code) 2.205
 CS-ID - Cell Station ID (PHS) 2.117; 3.110
 CW input/output 2.17
 CW signal (dig. mod.) 2.83

D

Data
 bits (RS232) 2.235; 6A.5
 generator
 installation 1.8
 slot 1.5
 input/output 2.11; 2.15; 2.86
 lines (IEC/IEEE-bus) 6A.1
 list (dig. mod.) 2.82; 2.93; 3.45
 check sum 4.2
 rate (CDMA) 2.133; 3.77
 DC offset calibration (dig. mod.) 2.60; 3.18
 DCL 3.140
 Decimal point 2.3; 3.9
 DECT 2.191; 3.33
 Default setting (CDMA) 2.126; 3.72
Delay
 clock
 CDMA 2.131; 3.75
 DECT 2.199; 3.36
 dig. mod. 2.101; 3.52
 GSM 2.184; 3.67
 NADC 2.145; 3.87
 PDC 2.163; 3.96
 PHS 2.112; 3.106
 signal
 DECT 2.198; 3.36
 fad. sim. 2.74; 3.58
 GSM 2.184; 3.66
 NADC 2.144; 3.87
 PDC 2.162; 3.95
 PHS 2.111; 3.106
 trigger
 CDMA 2.128; 3.74
 DECT 2.197; 3.36
 dig. mod. 2.99; 3.53
 GSM 2.188; 3.66
 NADC 2.143; 3.87
 PDC 2.161; 3.95
 PHS 2.110; 3.106

Delete
 all data stored 2.237; 3.132
 frame (DECT) 2.202; 3.38
 frame (GSM) 2.186; 3.69
 frame (NADC) 2.147; 3.90
 frame (PDC) 2.164; 3.98
 frame (PHS) 2.114; 3.108
 list 2.32

list entry 2.39
 mapping (CDMA) 2.132; 3.76
 memory 2.237; 3.132
Delimiter 3.140
Delta phase 2.239; 3.102
Detuning, external 2.238
Deviation
 FM 2.60; 3.54
 FSK (dig. mod.) 2.95; 3.50
 PM 2.62; 3.111
Deviation limits
 FM 2.61
 PM 2.63
Differential coding (dig. mod.) 2.94; 3.51
Digit cursor 2.22
Digital modulation 2.76; 3.41
 π/4DQPSK 2.77
 coding 2.77; 3.51
 constellation diagram 2.77
 control list 2.93; 3.47
 data list 2.93; 3.45
 envelope control 2.89; 2.101
 FSK 2.77
 menu 2.91
 modulation data 2.82; 2.92; 3.45
 modulation methods 2.77
 PRBS data 2.84
 PSK 2.77
 QAM 2.77
 setting conflicts 2.77
 trigger 2.98; 3.53
Digital standard
 DECT 2.191; 3.33
 GSM 2.177; 3.64
 IS-95 CDMA 2.118; 3.71
 NADC 2.137; 3.84
 PDC 2.155; 3.92
 PHS 2.104; 3.103
Digital synthesis (slot) 1.5
Disabling keyboard 3.130
Distortion factor 5.24
Doppler shift (fad. sim.) 2.73; 3.58
Downlink
 DECT 2.191
 GSM 2.177
 NADC 2.137
 PDC 2.155
 PHS 2.104
DUMMY Burst (GSM) 2.189
Duration blank signal 2.252; 3.124
Dwell list
 LIST 2.224; 3.78
 MSEQ 2.230; 3.131
Dwell time
 level sweep 2.222; 3.120
 LF sweep 2.224; 3.124
 LIST 2.224; 3.78
 MSEQ 2.233; 3.131
 RF sweep 2.221; 3.118

E

ECL output 2.103
Edge (external trigger) 2.252; 3.138
 dig. mod. 2.103; 3.53
Edit list 2.35
EMF 2.53
Enable register 3.144
Encryption scrambling (PHS) 2.116; 3.109

- Envelope control 3.8
- DECT 2.200; 3.37
 - dig. mod. 2.89; 2.101; 3.52
 - GSM 2.185; 3.67
 - NADC 2.145; 3.88
 - PDC 2.163; 3.96
 - PHS 2.113; 3.107
- EOI (command line) 3.8
- EPROM, test 4.2
- Equalizer (CDMA) 2.127
- Error messages 2.256; 3.133; 7B.1
- Error queue 3.127; 3.130; 3.151
- Error vector magnitude 5.29
- ESE (event status enable register) 3.147
- Event status enable register (ESE) 3.147
- Exponent 3.9
- Ext TUNE input 2.13; 2.238
- EXT1/2
- coupling 2.58; 2.60; 2.62; 3.30; 3.54; 3.111
 - input 2.19
- External detuning 2.238
- External modulation sources 2.54
- External reference 2.238; 3.117
- External trigger
- active edge 2.252; 3.138
 - active edge (dig. mod.) 2.103; 3.53
 - LIST 2.224; 3.137
 - MSEQ 2.231; 3.138
 - sweep 2.218; 3.136
- F**
- Fading simulation 2.68; 3.58
- Fading simulator
- calibration 2.246; 3.18
 - installation 1.8
 - slot 1.5
 - test 4.2
- Filter
- CDMA 2.127; 3.73
 - DECT 2.196; 3.35
 - dig. mod. 2.96; 3.51
 - GSM 2.182; 3.66
 - NADC 2.142; 3.86
 - PDC 2.160; 3.94
 - PHS 2.109; 3.105
- Fitting options 1.4
- FM
- carrier frequency deviation 2.60; 3.54
 - coupling 2.60; 3.54
 - deviation 2.60; 3.54
 - deviation limits 2.61
 - deviation setting 2.60; 3.54
 - distortion factor 5.35
 - frequency 2.60; 3.55
 - frequency response 5.34
 - modulator
 - slot 1.5 - preemphasis 2.60; 2.61; 3.55; 5.35
 - residual AM 5.36
- Format, data (IEC/IEEE bus) 3.24
- Forward Link signal (CDMA) 2.124; 3.72
- Frame
- DECT 2.202; 3.38
 - GSM 2.186; 3.68
 - NADC 2.147; 3.89
 - PDC 2.164; 3.97
 - PHS 2.114; 3.108
- Frequency
- accuracy 1.2; 5.9
 - AM 2.58; 3.30
 - FM 2.60; 3.55
 - indication 2.22
 - suppression 2.237; 3.23
 - LF generator 2.215; 3.121
 - LF sweep 2.223; 3.122
 - list (LIST) 2.224; 3.78
 - offset 2.45; 3.57
 - PM 2.62; 3.112
 - RF output signal 2.45; 3.56
 - RF sweep 2.220; 3.57
 - Frequency marker
 - LF sweep 2.224; 3.123
 - RF sweep 2.221; 3.82 - Frequency modulation (FM) 2.60; 3.54
 - Frequency sweep
 - LF 2.223; 3.124
 - RF 2.220; 3.118 - Front unit 1.5
 - FSK modulation (dig. mod.) 2.77
 - Full rate (CDMA) 2.134; 3.77
 - Functional test 4.1
- G**
- GET (Group Execute Trigger) 3.141
- GSM 2.177; 3.64
- Guard data field
- DECT 2.206
 - GSM 2.189
 - NADC 2.149
 - PDC 2.171; 2.173; 2.175
 - PHS 2.117
- H**
- Half rate (CDMA) 2.134; 3.77
- Handshake (RS232) 2.235; 3.129; 6A.6
- Harmonics suppression 5.12
- Header (commands) 3.6
- Header field (display) 2.22
- HOP mode (LIST) 2.224; 3.137
- HOP output 2.17
- HOP trigger signal (GSM) 2.188
- Hopping signal (dig. mod.) 2.83
- I/O
- constellation diagram 2.77
 - converter (slot) 1.5
 - modulation 2.65; 2.207; 3.41
 - modulator
 - calibration 2.66; 2.243; 3.20
 - slot 1.5 - I2 output 2.13
 - Idle data field (PHS) 2.117
 - IEC/IEEE bus
 - address 2.234; 3.129
 - interface 2.21; 6A.1
 - language 2.238 - Imbalance 2.66; 3.42
 - Impairment 2.66; 2.67; 3.41
 - Indentations 3.12
 - Indication
 - attenuator circuits 2.250
 - counter 2.250

- GSM 2.177; 3.64
- I/Q 2.65; 3.41
- inputs 2.54
- IS-95 CDMA 2.118; 3.71
- methods (dig. mod.) 2.77
- NADC 2.137; 3.84
- PDC 2.155; 3.92
- PHS 2.104; 3.103
- PM 2.62; 3.111
- pulse 2.64; 3.116
- simultaneous 2.56
- sources 2.54
- vector 2.65; 3.41
- Modulation depth
 - AM 2.58; 3.30
 - DECT 3.35
 - PM 2.62; 3.111
- Module indication 2.248; 3.22
- MSEQ (Memory Sequence) 2.230; 3.130; 3.138
- Multisignal measurements 2.50
- N**
 - NADC 2.137; 3.84
 - Name of sequence (MSEQ) 2.34; 3.132
 - NAN 3.9
 - New Line (command line) 3.8
 - NINF 3.9
 - Nonharmonics 5.12
 - NORM, Normal Burst (GSM) 2.187
 - NTRansition register 3.144
 - Numeric
 - input field 2.3
 - suffix 3.7
 - values 2.3; 3.9
 - Nyquist filter
 - CDMA 2.127; 3.73
 - DECT 2.196; 3.35
 - NADC 2.142; 3.86
 - PDC 2.160; 3.94
 - PHS 2.109; 3.105
- O**
 - Offset
 - frequency 2.46; 3.57
 - level 2.48; 3.114
 - Opening the casing 1.4
 - Operating modes
 - LIST 2.224; 3.57; 3.78; 3.115; 3.137
 - MSEQ 2.231; 3.130; 3.138
 - sweep 2.217; 3.57; 3.115; 3.118; 3.124; 3.136
 - Operating-hours 2.250; 3.22
 - Option
 - fitting 1.4
 - SM-B1 - Reference oscillator OCO 1.5; 2.238
 - SM-B5 - FM/PM modulator 1.6; 2.60; 2.62
 - SMIQB10 - Modulation Coder 1.7; 2.76
 - SMIQB11 - Data Generator 1.8; 2.82
 - SMIQB12 - Memory Extension 2.82
 - SMIQB14 - Fading Simulator 1.8; 2.68
 - SMIQB15 - Second Fading Simulator 1.8; 2.69
 - SMIQB19 - Rear panel connections for RF and LF 1.12
 - SMIQB42 - Digital Standard IS-95-CDMA 1.8; 2.118
 - Output
 - BB-AM 2.11
 - BIT CLOCK 2.11
 - BITCLK 2.17
 - BLANK 2.13; 2.224; 2.218; 2.252
 - buffer 3.142
 - CW 2.17
 - DATA 2.11; 2.15
 - ECL 2.103
 - HOP 2.17
 - I2 2.13
 - IQ AUX 2.13
 - LEV-ATT 2.15
 - level RF 2.47; 3.113
 - LF 2.21; 2.215; 3.28
 - MARKER 2.13; 2.219; 2.224; 2.252; 3.83; 3.123
 - POW RAMP 2.17; 2.89
 - power (fad. sim.) 2.69
 - Q 2.11
 - Q2 2.13
 - REF 2.21; 2.238
 - RF 2.11; 3.26; 3.56
 - SYMBCLK 2.15
 - SYMBOL CLOCK 2.11
 - TRIGOUT 2.15; 2.17
 - voltage 2.215; 3.28
 - X AXIS 2.13; 2.218
 - Output impedance 5.21
 - OVEN COLD 1.2
 - Overlapping execution 3.141
 - OVERLOAD 2.53
 - Overload protection 2.53; 3.26; 5.23
 - Overmodulation 2.56
 - Overview
 - menus 2.44
 - modulation sources 2.54
 - slots 1.5
 - status register 3.145
 - syntax elements 3.11
- P**
 - PAR DATA interface 2.87
 - Parallel modulation data 2.87
 - Parallel poll 3.151
 - Parallel poll enable register (PPE) 3.147
 - Parameter (commands) 3.9
 - Parity (RS232) 3.129; 6A.5
 - Password 2.240; 3.132
 - Path (commands) 3.6
 - Pattern setting
 - getting started 2.27
 - list editor 2.39
 - PDC 2.155; 3.92
 - Performance test 5.1
 - protocol 5.49
 - Period of output signal
 - DECT 2.198; 3.36
 - GSM 2.184; 3.67
 - NADC 2.144; 3.87
 - PDC 2.162; 3.95
 - PHS 2.111; 3.106
 - Personal station (PS)
 - DECT 2.191
 - GSM 2.177
 - NADC 2.137
 - PDC 2.155
 - PHS 2.104
 - Phase (RF output signal) 2.239; 3.102
 - Phase correlation coefficient (fad. sim.) 2.74; 3.58
 - Phase modulation 2.62; 3.111
 - PhM
 - deviation setting 5.37
 - distortion factor 5.38
 - frequency response 5.38

PHS..... 2.104; 3.103
 Physical quantities..... 3.8
 PM
 coupling..... 2.62; 3.111
 deviation..... 2.62; 3.111
 deviation limits..... 2.63
 frequency..... 2.62; 3.112
 generator..... 2.62; 3.112
 modulator..... 1.6; 2.62; 3.111
 slot..... 1.5
 Polarity
 BLANK signal..... 2.252; 3.26
 marker signal..... 2.252; 3.83; 3.123
 pulse modulation..... 2.64; 3.116
 POW RAMP input/output..... 2.17; 2.89
 Power
 channel (CDMA)..... 2.131; 2.133; 3.75; 3.76
 gating (CDMA)..... 2.134; 3.77
 ramping (DECT)..... 2.200; 3.37
 ramping (dig. mod.)..... 2.101; 3.52
 ramping (GSM)..... 2.185; 3.67
 ramping (NADC)..... 2.145; 3.88
 ramping (PDC)..... 2.163; 3.96
 ramping (PHS)..... 2.113; 3.107
 ratio (fad. sim.)..... 2.73; 3.58
 supply..... 1.1
 slot..... 1.5
 total (CDMA)..... 2.131
 PPE (Parallel poll enable register)..... 3.147
 PRBS data (dig. mod.)..... 2.84; 3.45
 Preamble
 normal..... 2.204
 prolonged..... 2.204
 Preamble (PHS)..... 2.117
 Preamble data field (PDC)..... 2.167; 2.173; 2.175
 Preemphasis (FM)..... 2.60; 2.61; 3.55; 3.55
 Preset (Instrument states)..... 1.3; 3.132
 Profile (fad. sim.)..... 2.72; 3.58
 Programming Examples..... 9D.1
 Protection level..... 3.132
 Protective circuit..... 2.53; 3.26
 PS-ID-Code-Data field (PHS)..... 2.117
 PSK modulation..... 2.77
 PTRansition register..... 2.144
 Pulling range..... 2.288
 PULSE input..... 2.13
 Pulse
 modulation..... 2.64; 3.116
 polarity..... 2.64; 3.116
 Pulse modulator
 dynamic characteristics..... 5.28
 ON/OFF Ratio..... 5.27
 Pure doppler profile (fad. sim.)..... 2.72; 3.58
 Putting into operation..... 1.1

Q

Q output..... 2.11
 Q2 output..... 2.13
 QAM modulation..... 2.77
 Quadrature error..... 5.32
 Quadrature offset..... 2.66; 3.42
 Queries..... 3.5
 responses..... 3.8
 Question..... 3.11
 Quick selection
 menu..... 2.25
 parameter..... 2.25
 Quotation marks..... 3.11

R

Rack 19"..... 1.12
 RAM, test..... 4.2
 Ramp data field
 NADC..... 2.149
 PDC..... 2.167
 PHS..... 2.116
 RAMP field..... 2.204
 Rayleigh fading..... 2.73; 3.58
 RCL list (MSEQ)..... 2.230; 3.131
 Recall
 frame (DECT)..... 2.202; 3.38
 frame (GSM)..... 2.186; 3.68
 frame (NADC)..... 2.147; 3.89
 frame (PDC)..... 2.164; 3.98
 frame (PHS)..... 2.114; 3.108
 instrument settings..... 2.43; 3.16
 mapping (CDMA)..... 2.132; 3.76
 REF input/output..... 2.21; 2.238; 3.117
 Reference
 external..... 2.238; 3.117
 frequency..... 5.11
 internal..... 2.238; 3.117
 oscillator (calibration)..... 2.241; 3.19
 oscillator OCXO..... 1.5; 2.238; 3.117
 Reference/Step Synthesis (slot)..... 1.5
 Remote control..... 3.1
 REMOTE state..... 3.2
 Remove paneling..... 1.4
 Reset status reporting system..... 152
 Residual AM..... 5.18
 Residual AM with FM..... 5.36
 Residual carrier..... 5.31
 Residual FM..... 5.18
 Residual PhiM with AM..... 5.26
 Responses to queries..... 3.8
 Reverse link signal (CDMA)..... 2.134; 2.135; 3.72
 RF
 frequency..... 2.45; 3.56
 output..... 2.11; 3.26
 output level..... 2.47; 3.114
 sweep..... 2.220; 3.118
 RF OFF..... 2.53
 Ricean fading..... 2.73; 3.58
 Roll-off factor
 CDMA..... 2.127; 3.73
 dig. mod..... 2.97; 3.51
 NADC..... 2.142; 3.86
 PDC..... 2.160; 3.94
 PHS..... 2.109; 3.105
 Rotary knob..... 2.7; 2.23
 RS232 interface..... 2.19; 2.235; 3.129; 6A.4

S

Sample setting..... 2.27
 Sample-and-hold mode..... 2.50
 Save
 frame (DECT)..... 2.202; 3.38
 frame (GSM)..... 2.186; 3.68
 frame (NADC)..... 2.147; 3.89
 frame (PDC)..... 2.164; 3.98
 frame (PHS)..... 2.114; 3.108
 instrument settings..... 2.43; 3.16
 mapping (CDMA)..... 2.132; 3.76
 SCPI
 conformity information..... 8C.1
 introduction..... 3.5
 Scrambling

- PDC 2.167; 2.175; 3.99
 - PHS 2.116; 3.109
 - Scrollbar 2.23
 - Select
 - 1-out-of-n 2.24
 - mark 2.22
 - Self test 3.16; 3.134; 4.1
 - Semicolon 3.11
 - SER DATA input 2.236
 - SERDATA-interface 6A.7
 - Serial modulation data (dig. mod.) 2.86
 - Serial number 2.250; 3.15
 - Serial poll 3.150
 - Service request (SRQ) 3.16; 3.150
 - Service request enable register (SRE) 3.16; 3.146
 - Setting commands 3.5
 - Setting conflicts (dig. mod.) 2.77
 - Setting value 2.24
 - Settling bit 3.148
 - Settling time
 - frequency 5.10
 - level 5.20
 - Short form (commands) 3.7
 - Sign 3.9
 - Signal (data generator)
 - BGATE (burst gate) 2.83
 - CW (continuous wave) 2.83
 - HOP (hopping) 2.83
 - LATT (level attenuation) 2.83
 - TRIG1/2 (trigger output1/2) 2.83
 - Simultaneous modulation 2.56
 - Slot (DECT) 2.204
 - Slots 1.5
 - Software option 1.8; 2.254
 - Software version 2.250; 3.22
 - Source resistance 2.53
 - Span (RF sweep) 2.220; 3.57
 - Special characters 3.13
 - Spectral purity 2.61; 2.63
 - Square brackets 3.7
 - SRE (service request enable register) 3.16; 3.146
 - SRQ (service request) 3.16; 3.150
 - SSB phase noise 5.16
 - STANDBY mode 1.1; 1.2; 2.9
 - Start bit (RS232) 6A.5
 - Start frequency
 - LF sweep 2.224; 3.122
 - RF sweep 2.220; 3.57
 - Start level (level sweep) 2.222; 3.115
 - State REMOTE 3.2
 - STATus
 - OPERation register 3.126; 3.148
 - QUESTionable register 3.127; 3.149
 - Status byte (STB) 3.146
 - Status line 2.22
 - STATUS page 2.255
 - Status register (overview) 3.145
 - Status reporting system 3.143
 - STB (status byte) 3.146
 - Steal Flag data field (PDC) 2.168; 2.176
 - Step width
 - frequency 2.45; 3.58
 - level 2.48; 3.115
 - level sweep 2.222; 3.120
 - LF sweep 2.224; 3.125
 - RF sweep 2.220; 3.119
 - rotary knob
 - frequency variation 2.45; 3.58
 - level 3.115
 - level variation 2.48
 - Stop bit (RS232) 2.235; 3.129; 6A.5
 - Stop frequency
 - LF sweep 2.224; 3.122
 - RF sweep 2.220; 3.58
 - Stop level (level sweep) 3.115
 - Storage 4.1
 - Store
 - frame (DECT) 2.202; 3.38
 - frame (GSM) 2.186; 3.68
 - frame (NADC) 2.147; 3.89
 - frame (PDC) 2.164; 3.98
 - frame (PHS) 2.114; 3.108
 - instrument settings 2.43; 3.16
 - list 2.35
 - mapping (CDMA) 2.132; 3.76
 - Structure
 - command 3.6
 - command line 3.8
 - Sum bit 3.144
 - Sum deviation 2.56
 - Sum modulation depth 2.56
 - two-tone modulation 2.56
 - Summing loop 2.242
 - slot 1.5
 - Sweep 2.216
 - level 2.222; 3.115; 3.120
 - LF 2.223; 3.124
 - outputs 2.218
 - RF 2.220; 3.57; 3.118
 - trigger 2.218; 3.136
 - Switchover to remote control 3.2
 - SYMBCLK input/output 2.15; 2.87
 - Symbol 2.25
 - Symbol clock
 - CDMA 2.100; 3.51
 - dig. mod. 2.145; 3.87
 - NADC 2.162; 3.95
 - PDC 2.112; 3.106
 - PHS 2.11; 2.85
 - SYMBOL CLOCK input/output 2.11; 2.85
 - Symbol rate
 - DECT 2.130; 3.35
 - dig. mod. 2.95; 3.50
 - GSM 2.182; 3.66
 - NADC 2.142; 3.86
 - PDC 2.160; 3.94
 - PHS 2.109; 3.105
 - Synchronization
 - CDMA 2.121
 - command 3.142
 - DECT 2.192
 - PHS 2.105
 - signal generation (dig. mod.) 2.83
 - Synthesis range 2.61; 2.63
- ## T
- Tail data field (GSM) 2.188
 - TCH, Traffic Channel configuration
 - NADC 2.149; 3.90
 - PDC 2.166; 3.98
 - PHS 2.116; 3.109
 - Test 2.250
 - Test points 2.249; 3.22
 - Total power (CDMA) 3.75
 - Training Sequence Code (GSM) 2.188
 - Trigger
 - active edge 2.252; 3.138
 - active edge (dig. mod.) 2.103; 3.53
 - CDMA 2.127; 3.74
 - DECT 2.192; 2.196; 3.35

dig. mod. 2.98; 3.45; 3.53
 GSM 2.182; 3.66
 inhibition (CDMA) 2.129; 3.74
 inhibition (DECT) 2.198; 3.36
 inhibition (dig. mod.) 2.99; 3.53
 inhibition (GSM) 2.183; 3.66
 inhibition (NADC) 2.144; 3.87
 inhibition (PDC) 2.161; 3.95
 inhibition (PHS) 2.111; 3.106
 input 2.231; 2.252
 input 2.224
 LIST 2.224; 3.137
 MSEQ 2.231; 3.138
 NADC 2.142; 3.86
 oscilloscope 2.218; 3.82
 PDC 2.160; 3.94
 PHS 2.105; 2.109; 3.105
 sweep 2.218; 3.136
 XY recorder 2.218; 3.118
 TRIGGER input 2.13
 Triggering action 2.25
 TRIGIN input 2.15
 TRIGOUT output 2.15; 2.17
 Truth values 3.8
 Tuning voltage 2.239
 Two-channel fading 2.69
 Two-tone modulation 2.56

U

UCOR (level correction) 2.51; 3.31
 Unique word (PHS) 2.117
 Unit 2.5; 3.8; 3.139
 Universal commands 6A.3
 Uplink
 DECT 2.191
 GSM 2.177
 NADC 2.137
 PDC 2.155
 PHS 2.104
 User correction (UCOR) 2.51; 3.31

V

VCO SUM calibration 2.242; 3.19
 Vector error 5.29
 Vector modulation 2.65; 2.66; 2.207; 3.41; 5.28
 calibration 2.243; 3.20
 IQ imbalance 5.31
 level control POW RAMP 5.32
 modulation frequency response 5.30
 quadrature error 5.32
 residual carrier 5.31
 Ventilation ducts 1.4
 Voltage
 external modulation signal 2.55
 LF output 2.215; 3.28
 VOX
 PDC 2.174; 3.98
 PHS 2.116; 3.109
 VSWR 5.21

W

Walsh code (CDMA) 2.132; 3.76
 White space 3.11

X

X field (DECT) 2.205
 X AXIS output 2.13; 2.218
 XY recorder 2.218; 3.118

Z

Z field (DECT) 2.206; 3.40

